

Acute effects of stretching on athletic performance
The ability of some exercises in compensating
stretching-related performance deficits

A dissertation submitted to the Faculty of Empirical Human
Science of the Saarland University in partial fulfillment of the
requirements for the degree of Doctor of Philosophy

Submitted by:

MOHAMMED RAJAAI MAHLI

- 1. Supervisor: Univ.- Prof. Dr. GEORG WYDRA**
- 2. Supervisor: PD. Dr. ANDREAS KLEE**

Committee members:

Univ.- Prof. Dr. STEFAN PANZER

Univ.- Prof. Dr. EIKE EMRICH

Dr. Phil. FRANZ MARSCHALL

Dean:

Univ.- Prof. Dr. JOCHEN KUBINIOK

Saarbrücken, 2012

Acknowledgement

I would never have been able to finish my dissertation without the guidance of my supervisor, help from friends, and the support from my family and wife.

Foremost, I would like to gratefully and sincerely thank my supervisor Univ.-Prof. Dr. Georg Wydra for his guidance, understanding, caring, and most importantly, his friendship during my study at the Sport Science Institute (SWI) of the Saarland University. His mentorship was paramount in providing a well rounded experience consistent my long-term career goals. His patience and support helped me overcome many crisis situations and finish this dissertation. For everything you've done for me, Mr. Wydra, I thank you so much.

I am also very grateful to my co-referee Priv.-Doz. Dr. Andreas Klee for accepting the invitation to be the second examiner of my thesis and for discussing the course of the research and for his valuable advices.

Many thanks go to Dr. Markus Schwarz (Saarland University), Prof. Dr. Christian Haas (Hochschule Fresenius) and Dr. Sameh Kassem (Tishreen University in Syria) for their assistance and practical advices. I am also thankful to PD Dr. Michael Fröhlich, Dr. Franz Marschall and MA Stephanie Kersten for reading my dissertation, commenting on my views and helping me to understand and enrich my ideas.

This dissertation was corrected for grammar by Nathan Smith, a student from the USA who studies at the German Language and Literature Institute of the Saarland University. I am also grateful for his help.

Furthermore, I want to express my gratitude to all the staff of the SWI, especially Beatrix Giese-Manzone, Lisa Grub, Stephanie Kersten, Jaime Carcamo and Sangbok Moon. I would never forget the cooperativeness and friendly atmosphere, and the beautiful memories we had in our teamwork. I wish you all good academic successes and all the best for your future plans.

I would also like to thank my parents Ahmad and Thanaa, my sister Dr. Reem and my brothers Rami, Reda and Nour. They were always supporting me and encouraging me with their best wishes. Finally, I would like to thank my wife, Alaa Ksairawy. She was always there cheering me up and stood by me through the good times and difficult.

Index of Contents

1	INTRODUCTION.....	6
2	THEORETICAL BASES	10
2.1	Warm-up	10
2.1.1	Types of warm-up.....	10
2.1.2	Mechanisms of warm-up	11
2.1.3	Postactivation potentiation (PAP)	12
2.2	Flexibility	22
2.2.1	Flexibility in sport	22
2.2.2	Factors influence on flexibility	23
2.3	Stretching	23
2.3.1	Anatomy and physiology of stretching	24
2.3.2	Types of stretching	29
2.3.3	Evaluation of stretch-types according to their efficiency in improving flexibility .	35
2.3.4	Active-passive vs. self-external stretching	37
2.3.5	Acute effects of static stretching	39
2.3.6	Compensating the stretching-related deficits in performance.....	72
2.3.7	The aim of the investigations in this thesis	75
3	FIRST STUDY: ACUTE EFFECTS OF STATIC AND DYNAMIC STRETCHING ON ISOKINETIC FORCE AND FLEXIBILITY	76
3.1	Introduction	76
3.2	Methods	77
3.2.1	Subjects	77
3.2.2	Variables	78
3.2.3	Treatments.....	80
3.2.4	Study design.....	81
3.2.5	Hypothesis.....	82
3.2.6	Statistical analyses	82
3.3	Results.....	82
3.3.1	Test-retest reliability	82

3.3.2	Isokinetic peak torque.....	83
3.3.3	Angle at peak torque.....	84
3.3.4	Hip flexion range of motion.....	85
3.4	Discussion.....	86
4	SECOND STUDY: ACUTE EFFECTS OF STATIC STRETCHING FOLLOWED BY VARIOUS ACTIVATION EXERCISES ON JUMP PERFORMANCE IN TRIPLE-HOP.....	88
4.1	Introduction.....	88
4.2	Methods.....	89
4.2.1	Subjects.....	89
4.2.2	Variables.....	89
4.2.3	Treatments.....	90
4.2.4	Study design.....	91
4.2.5	Hypothesis.....	92
4.2.6	Statistical analyses.....	93
4.3	Results.....	93
4.3.1	Test-retest reliability.....	94
4.3.2	Jump performance following static stretching.....	94
4.3.3	Restoring baseline performance.....	94
4.3.4	Jump performance with or without static stretching.....	95
4.4	Discussion.....	96
5	THIRD STUDY: ACUTE EFFECTS OF STATIC STRETCHING FOLLOWED BY WEIGHTED JUMPS ON VERTICAL JUMP PERFORMANCE.....	98
5.1	Introduction.....	98
5.2	Methods.....	99
5.2.1	Subjects.....	99
5.2.2	Variables.....	99
5.2.3	Treatments.....	106
5.2.4	Study design.....	107
5.2.5	Hypothesis.....	108
5.2.6	Statistical analyses.....	108
5.3	Results.....	108
5.3.1	One repetition maximum Test (1-RM).....	108

5.3.2	Test-retest reliability	109
5.3.3	Jump height	109
5.3.4	Peak force and contact time	110
5.3.5	Muscles activity	112
5.4	Discussion	114
6	SUMMARY AND FUTURE PERSPECTIVES	120
6.1	First study	120
6.2	Second study	121
6.3	Third study	121
6.4	Conclusions of the dissertation	122
6.5	Critical points in the study	123
6.6	Future perspectives	124
	REFERENCES	125
	APPENDIX	143

List of abbreviation

AC	Antagonist-contrast stretching	1-RM	One repetition maximum
BPM	Heart beats pro minute	ROM	Range of motion
CMJ	Countermovement jump	SBJ	Stand broad jump
CR	Contract-relax stretching	SD	Standard deviation
CR-AC	Contract-relax antagonist-contrast stretching	sec	Seconds
°	Degree	sig.	Significant
°C	Degree Celsius	SJ	Squat jump
DJ	Drop jump	SQ	Squat
EMG	Electromyography	SS	Static stretching
ES	Effect size	tab.	Table in appendix
ex.	Exercise	TC	Contact time
F	F-statistics	VO ₂	Oxygen consumption
fig.	Figure in appendix	WJ	Weighted jumps
JD	Jump distance		
JH	Jump height		
JU	Maximal jumps		
IEMG	Integrated electromyography		
ISO	Isometric squat		
DS	Dynamic stretching		
LCMJ	Loaded countermovement jump		
M	Mean		
min	Minutes		
mm	Millimetre		
mV	Millivolt		
MVC	Maximum voluntary contraction		
<i>P</i>	Statistical significance level		
PAP	Postactivation potentiation		
PF	Peak force		
PNF	Proprioceptive neuromuscular facilitation		
POD	Point of discomfort		
PP	Peak power		
rep.	Repetitions		

1 Introduction

Athletes usually accomplish a warm-up program prior to each training session or competition. The expected effects of this procedure are to achieve optimum performance by preparing the athletes physically and mentally, in addition to minimizing the risk of injury by preparing the muscles, tendons and joints for more strenuous activities (Alter, 1998; Walker, 2007; Young & Behm, 2002). However, the claimed effectiveness of warm-ups on optimizing performance is usually based on the trial and error experience of the athlete or coach, rather than on scientific study. Furthermore, the research of warming-up shows conflicting results (Bishop, 2003b).

Warm-ups typically contain three basic components: most athletes begin with low-intensity aerobic components such as running, swimming, cycling etc. in order to elevate the heart rate and respiratory rate, and to increase the muscle temperature. Then, athletes stretch the specific muscles involved in the following activity. Finally practicing some of the sport specific warm-ups which involve rehearsing of the skills, movements and actions which are about to be performed in the following sporting event (Walker, 2007; Wiemeyer, 2002; Young & Behm, 2002).

Stretching is commonly included in the warm-up in both training and competitive situations (Ylinen, 2008), in addition to the use of stretching separately in order to improve the flexibility. Although there are various types and methods of stretching, there still remains the static stretching (primarily passive) the most popular method used in the warm-up (Young & Behm, 2002). Since the static stretching came into view, especially after the propagation from Anderson (1980), Sölveborn (1983) and Knebel (1985), static stretching is often prescribed to athletes in the belief that a stretched muscle helps reduce muscular injuries and that it prepares the muscle for the mechanical twitch tension involved in the following activity (Wiemann & Klee, 2000). The world's most popular stretching authority Bob Anderson with more than three million sold copies worldwide of his book "stretching", reported:

"...it (stretching) is the important link between the sedentary life and the active life. It keeps the muscles supple, prepares you for movement, and helps make daily transition from inactivity to vigorous activity without undue strain. It is especially important if you run, cycle, play tennis, or promote tightness and inflexibility, because such activities require tensions and movement-difficulties. Stretching before and after you work out will keep you flexible and may prevent common injuries such knee problems from running and sore shoulders or elbows from tennis". (Anderson, 1980, pp. 8-9)

However, a number of recent investigations have reported a temporary reduction in force, power and sprint performance following static stretching. Kovacs (2010) reported: “contrary to the typical belief that static stretching improves physical activity, there have been numerous studies that demonstrate that traditional static stretching actually has the reverse effect ” (Kovacs, 2010, p. 14). Winchester, Nelson and Kokkonen (2009) observed a reduction in 1-RM of knee flexion after a static stretching bout. Sekir, Arabaci, Akova and Kadagan (2010) reported a significant decrease in concentric and eccentric isokinetic peak torque following a bout of static stretching in elite women athletes. Behm and Kibele (2007) observed that static stretching by various stretch-intensities had a negative influence on the following jumping performance in countermovement jump (CMJ), squat jump (SJ) and drop jump (DJ), as well as in the study of Bradley, Olsen and Portas (2007) jump performances in CMJ and SJ were also affected. Significant decreases in sprint performance were also registered following static stretching, such as in the studies of Fletcher and Jones (2004), Hillebrecht, Robin and Böckmann (2007), Nelson, Driscoll, Landin, Young and Schexnayder (2005), Sayers, Farley, Fuller, Jubenville and Caputo (2008). All these findings showed that static stretching has no acute positive consequence on athletic performance, and mostly even negative effects.

Despite all previous findings, many athletes still implicate static stretching in their warm-ups and even before the events in which force, power and sprint performance are influential for performance. Schneider, Schmitt, Zalewski and Gantz (2011) accomplished a standardized and anonymous questionnaires at the Olympic training centre Rhein-Neckar in Germany with 273 competitive elite athletes of 24 types of sports. Athletes were questioned of their actual use of stretching before training and competition. 80 % of the questioned athletes implicate discipline-specific stretch exercises in training, before or during competition. Possible explanations for this behaviour might be that some athletes do not yet know about these negative effects of static stretching on the following performance. 74 % of the questioned athletes in the study of Schneider et al. (2011) declared that they were not provided with sufficient information or recommendations to the latest knowledge of the sport science. Some athletes already know about this phenomenon but they did not believe it yet. Schneider et al. (2011) reported that 55 % of the questioned athletes practice stretching in training and competition although they have a negative opinion about stretching. Some athletes still think that merely through static stretch exercises they can achieve a greater joint's range of motion or prevent themselves from injuries and not through other techniques. Schneider et al. (2011) reported that 76 % of the questioned competitive athletes think that stretching protect them from injuries. Some Athletes are not able to relinquish practicing static stretching due to habitual-psychological reasons. Young (2007) reported: “given that static stretching is a traditional warm-up practice, suddenly eliminating this element might have a negative psychological effect on some athletes, especially if they have a history of using it and a belief in its benefits” (Young, 2007, p. 215).

Just a few recent investigations aimed at finding out which procedure would really suit in compensating for this decrement in performance which is caused from static stretching. Hillebrecht et al. (2007) reported that short-term reduction of performance after stretching could be at least partly restored with suitable compensation procedures. Turbanski (2005) hypothesized, that a motion sequence with maximum contractions after stretching must be performed before competing. Taylor, Sheppard, Lee and Plummer (2009) suggested that a period of high-intensity sport-specific skills based activity is recommended immediately following the static stretching which is to be included in the warm-up period prior to the training and competition situations in order to prevent any of the harmful effects associated with static stretching. Hillebrecht and Niederer (2006) compared the ability of the vertical jumps, isometric contractions and maximal sprints in restoring the reduction in drop jump performance obtained by previous static stretching. A further study by Hillebrecht et al. (2007) investigated the effect of submaximum sprints in restoring the sprint performance which was acutely affected by a bout of static stretching. Taylor et al. (2009) investigated if a specific warm-up could compensate the loss of jump and sprint performances which was induced by static stretching. Pearce, Kidgell, Zois and Carlson (2009) also investigated if movement activity exercises (high knees run, side stepping, cross over, skip steps and zig-zag running) could restore performance after static stretching. Exercises that would be better suit in compensating this performance decrement are still insufficiently investigated. The several possible variations of modes, intensities, repetitions, durations, recovery periods of exercises which are expected to be able to restore performance after static stretching shows a huge lack of knowledge to this problem.

Therefore, in order to design more effective warm-up, this study goaled to help athletes who cannot avoid or who don't want to relinquish practicing static stretching in the warm-up (for whatever the reason is) by giving them instructions and suggestions on how to quickly compensate for these temporarily decreases of performance. It was hypothesized that performance-deficits according to a proceeded static stretching can be (partly or completely) compensated using an activation exercise such as half squats or weighted jumps, which were already suggested in the literature to be able to induce the so-called "postactivation potentiation phenomenon".

In this thesis, the theoretical basis of warm-up, postactivation potentiation, flexibility and stretching will be at first represented. Recent reviews of the literature were reviewed for the acute effects of postactivation potentiation and static stretching on athletic performance. The empiric part of the dissertation consists of three studies. The first study aimed to investigate and compare the acute effects of static and dynamic stretching on maximal isokinetic force. In the second study the acute effects of static stretching as well as the ability of various exercises in restoring jump performance decreased following static stretching were investigated. The third study aimed also to investigate the acute effects of static stretching on vertical jump performance as well as the ability of weighted jumps in restoring the expected performance-deficits follow-

ing stretching. The measurements of electrical muscle activity (EMG) applied in the third study may give information about possible changes in the electrical properties of the investigated muscles and may help to give a theoretical interpretation for the phenomenon of decreasing performance following static stretching as well as the possible changes following the investigated exercise which was used to compensate this decrement.

2 Theoretical bases

The theoretical part of the dissertation includes descriptions of types and mechanisms of warm-up, mechanisms of the postactivation potentiation phenomenon, a recent review to the acute effects of various activation-exercises, the flexibility, anatomy and physiology of stretching, types of stretching as well as a recent review to the acute effects of static stretching.

2.1 Warm-up

Any type of movements or activities which are practiced prior to training or competition in order to produce optimal physiological and psychological status to achieve as much as possible the best of the reachable performance in the following activity, in addition to the prevention from injuries, can be considered as a warm-up intervention. The warm-up should prepare the athlete for the following performance, but should not induce fatigue (Jeffreys, 2008).

2.1.1 Types of warm-up

2.1.1.1 Active warm-up vs. passive warm-up

Active warm-up involves movements or exercises such as running, stretching, calisthenics, cycling, swimming etc., and these movements are likely to induce greater metabolic and cardiovascular changes than passive warm-up (Bishop, 2003a). In the passive warm-up muscle temperature or core temperature will be raised by some external procedures such as massage, hot shower, sauna etc. (Apfel, 2002; Bishop, 2003a). The sense of this type is to increase muscle temperature or core temperature as in active warm-up without depleting energy substrates (Bishop, 2003a). However, no effect of passive warm-up on blood circulation, muscles contraction, improvement of performance or injuries prophylaxis are expected. Therefore, the passive warm-up cannot be separately applied without an additional active warm-up (Apfel, 2002).

2.1.1.2 General warm-up vs. specific warm-up

The aim of the general warm-up is to increase the body temperature and the psychological accommodation through active movements of big muscles of the body (not specific to the sport type) with light intensities. The specific warm-up is the psychophysical preparation to the specific requirements of an athletic discipline through movements identical to the specific movements of the sport type (Apfel, 2002).

2.1.1.3 Mental warm-up

The mental warm-up can be accomplished via mental playing through the previously trained movements. An improvement in performance is expected just in a better automated movement. Therefore, this warm-up can just be used additionally to the active warm-up (Apfel, 2002).

2.1.2 Mechanisms of warm-up

Bishop (2003a) investigated the possible mechanisms underlying the effect of warm up and he classified these mechanisms into two categories: temperature related and non-temperature related mechanisms.

2.1.2.1 Temperature related mechanisms

The temperature related mechanisms are mostly reported responsible for the effects of warm up. An increase in muscle temperature or core temperature affect the following parameters (Bishop, 2003a, p. 441):

- Decreased viscous resistance of muscle and joints.
- Increased oxygen delivery to muscles: hemoglobin at 41°C gives out almost twice as much oxygen than at 36°C, and the oxygen dissociates from hemoglobin about twice faster.
- Enhancement of aerobic energy production by speeding the rate-limiting oxidative reactions.
- Increased anaerobic metabolism: An increase in muscle temperature caused more rapid muscle glycogen breakdown and this increases the anaerobic metabolism for short-term and intermediate performance and not for long-term performance.
- Increased nerve conduction rate: an improvement in performance is proposed by the increased function of the nervous system as a result of an increase in muscle temperature.
- Increased thermoregulatory strain.

2.1.2.2 Non-temperature related mechanisms

The following mechanisms are proposed as non-temperature related mechanisms of warm-up (Bishop, 2003a, p. 443):

- Metabolic effects of active warm-up: a number of metabolic changes occur in response to active warm up which may affect the oxygen delivery to the muscles and this will improve the performance.
- Elevation of baseline oxygen consumption: warm-up may allow subsequent tasks to begin with elevated baseline oxygen consumption (VO_2), and this will reduce the initial work with the aerobic energy, storing this energy for later usage (figure 1).
- Breaking of actin-myosin bonds: warm-up may disturb actin-myosin bonds and thereby reduce the passive stiffness of muscle which may cause an increase in rate of force development and in power during short-duration tasks.
- Psychological effects: many of improvements in performance are attributed to psychological mechanisms. Athletes who imagined a warm-up have an enhanced

physiological performance (Malareki, 1954; as cited in Bishop, 2003a, p. 445). Additionally, warm-up may also provide valuable time to mentally prepare for the following events.

- Postactivation potentiation.

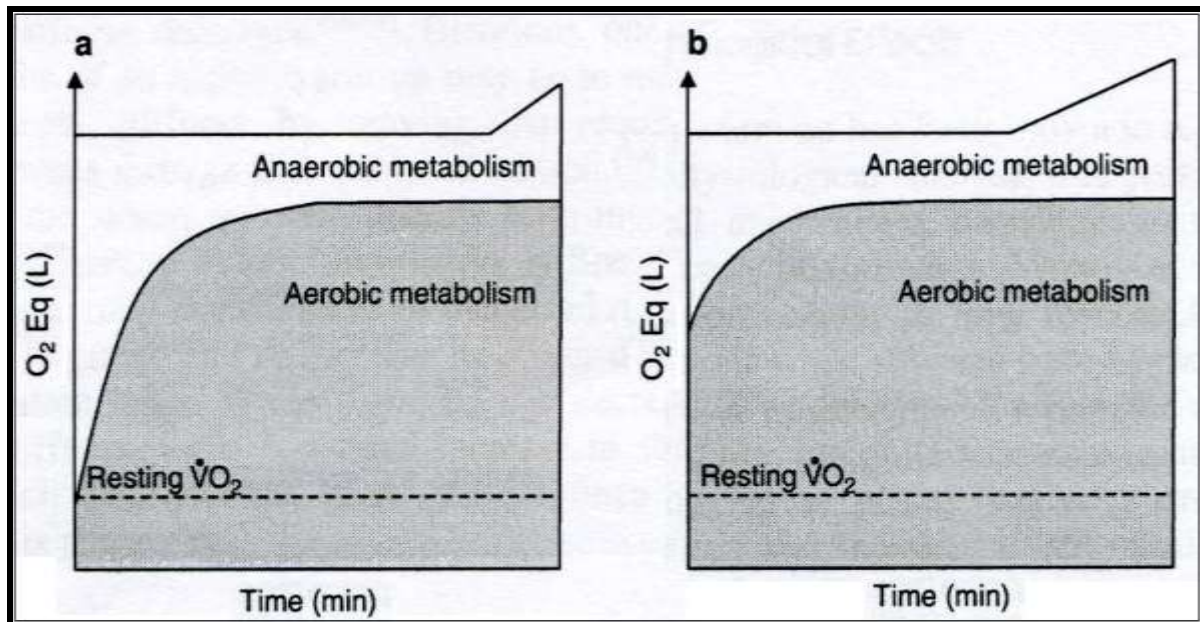

Figure 1: The aerobic and anaerobic contribution with (a) and without (b) prior warm-up. $\dot{V}O_2$: oxygen consumption, Eq: oxygen equivalents (from Bishop, 2003a, p. 444).

2.1.3 Postactivation potentiation (PAP)

Postactivation potentiation is “a phenomenon by which acute muscle force output is enhanced as a result of contractile history” (Robbins, 2005, p. 453). When this enhancement of muscle force output is provoked by a muscle voluntary contraction it would be called postactivation potentiation, and when it is induced by electrical stimulation then it would be called posttetanic potentiation (Baudry & Duchateau, 2004; Hamada, Sale & MacDougall, 2000). Sale (2004, p. 386) defined the postactivation potentiation (or activity-dependent potentiation) as “an increase in muscle isometric twitch and low frequency titanic force following a conditioning activity”. Sale (2004) also reported that any type of contractile activity is likely to activate the mechanism of postactivation potentiation and not only after a heavy resistance exercise.

In contrast to neuromuscular fatigue, postactivation potentiation facilitates the volitional production of force (Sale, 2002; Hodgson, Docherty & Robbins, 2005). Neuromuscular fatigue is a decrease in force which is observed after repeated muscle activa-

tion (Hodgson et al., 2005). Furthermore, postactivation potentiation could be helpful in compensating the impaired excitation-contraction coupling that occurs with fatigue (Sale, 2004).

2.1.3.1 Postactivation potentiation mechanisms

There are two accepted mechanisms underlying postactivation potentiation:

- The phosphorylation of myosin regulatory light chains, which increases the ionized calcium (Ca^{+2}) sensitivity of the myofilaments and thereby enhances the force of the twitch (Sale, 2004; Baudry & Duchateau, 2004; Hodgson et al., 2005; Parry, Hancock, Shiells, Passfield, Davies & Baker, 2008).
- Postactivation potentiation enhances the Hoffmann reflex, thus increasing the efficiency and rate of the nerve impulses to the muscle (Hodgson et al., 2005; Parry et al., 2008). Hoffmann reflex is a “monosynaptic reflex induced by an electrical stimulation of group Ia afferents of the muscle nerve” (Hodgson et al., 2005, p. 587). This increase in Hoffmann reflex causes greater neural activation in a following muscular activity (Parry et al., 2008).

The conditioning activity can concurrently increase (due to PAP) and decrease (due to fatigue) low and high frequency force, respectively (Sale, 2002). Greatest effect of increased sensitivity to Ca^{+2} is at low myoplasmic level of Ca^{+2} , and has a little or no effect at saturated Ca^{+2} levels (Sale, 2002; Hodgson et al., 2005).

2.1.3.2 Optimal recovery time for postactivation potentiation

The optimal recovery time is when the muscle has recovered from fatigue and is still potentiated (Hodgson et al., 2005; Parry et al., 2008). The longer the recovery period after the conditioning activity, the greater recovery from fatigue, but also the greater the decay of PAP (Sale, 2004). Baudry and Duchateau (2004) reported that postactivation potentiation decayed within 7-10 minutes recovery time. In another study, Baudry and Duchateau (2007) reported that twitch potentiation was maximal immediately after the muscle voluntary contraction (MVC), but the rate of torque development of electrically induced and ballistic voluntary contractions was maximally enhanced one minute after the MVC and remained potentiated during five minutes. Gourgoulis, Aggeloussis, Kasimatis, Mavromatis and Garas (2003) found a significant increase in jump height of the countermovement jump immediately after a warm up period including five sets of half-squats. In the study of Hoffman (2007) it was found that the countermovement jump height and peak power significantly increased after performing a 1-RM-squat-test and after a recovery period of five minutes. In contrast, Hanson, Leigh and Myrark (2007) reported no significant changes in jump performance after neither a heavy- nor a light-set of squats with a recovery period of five minutes before post-test. It

seems that optimal recovery time is to be variable among individuals (Hodgson et al., 2005). Additionally, the magnitude of postactivation potentiation is affected both by the methods used to evoke it and the characteristic of the muscle (Hamada et al., 2000).

2.1.3.3 A recent review to the effects of various activation-exercises

The aim of this review was to find out which procedures or exercises could increase subsequent performance by inducing PAP mechanisms. These procedures or exercises are hypothesized to be able to compensate the possible performance-deficits following static stretching. A total of 31 recent studies were reviewed. Pub-med and the electronic journals library of the Saarland University were searched for all articles related to postactivation potentiation and acute effects of strength, squat, maximum voluntary contraction (MVC), repetition maximum (RM) or jump exercises on athletic performance. The athletic performance in jumping (with or without extra load), force (isokinetic, isometric) or sprinting were measured as a criteria in order to investigate the effects of various activation exercises. A detailed summary of each study can be found in table 1.

Table 1: A review to the acute effects of various activation-exercises on athletic performance

Research	Subjects	Treatment	Criteria	Results
Gourgoulis et al. (2003): "Effect of a submaximal half-squats warm-up program on vertical jumping ability"	20 physically active men	5 sets x 2 rep. of sub-maximal half-squats at 20, 40, 60, 80, and 90% of 1-RM (post-test immediately after Treatment)	- JH in CMJ	Sig. improvement in JH
Koch et al. (2003): "Effect of warm-up on the standing broad jump in trained and untrained men and women"	32 trained and untrained men & women	a) 3 rep. squats at 50, 75, and 87.5% of 1-RM (3 min rest) b) 3 rep. speed squats at 20, 30, and 40% of 1-RM (3 min rest) c) Stretching (8 min of various exercises with 10 sec hold) d) Control	- Jump distance (JD) by stand-broad-jump- test (SBJ)	- No sig. difference between the groups, - A high correlation between 1-RM and JD
Chiu et al. (2003): "Postactivation potentiation response in athletic and recreationally trained individuals"	7 athletes in sports requiring explosive strength (ATH), and 17 recreationally trained individuals (RT)	5 sets x 1 rep. at 90% of 1-RM squats. (2 min rest between sets)	- Force and power by jump squats with 30%, 50% and 70% of 1 RM (only concentric and eccentric+ concentric)	- No effect when all subjects were compared. - Sig. greater force and power just for ATH
Baudry & Duchateau (2004): "Postactivation potentiation in human muscle is not related to the type of maximal conditioning contraction"	9 subjects	a) 6 sec isometric MVC b) 6 sec concentric MVC c) 6 sec eccentric MVC	muscle twitch torque in the tibialis anterior	- Sig. enhancement in twitch torque and its maximal rate of torque development and relaxation (no differences between the 3 conditions). - All parameters returned to initial values within 7-10 min
Scott & Docherty (2004): "Acute effects of heavy preloading on vertical and horizontal jump performance"	19 strength-training-active men	5-RM squats	- JH in CMJ - JD in SBJ	No sig. difference in JH or JD

Research	Subjects	Treatment	Criteria	Results
Bazett-Jones et al. (2005): "Effect of potentiation and stretching of force, rate of force development and range of motion"	10 male collegiate track and field athletes	a) 10 min rest (control). b) 30 min stretching. c) 3 sets x 3 rep. leg press at 90% of 1-RM with 3 min rest between sets	- Maximal force PF and rate of force development RFD in an isometric squat	- PF was not sig. different following any of the three conditions. - RFD was sig. lower in (c) from (a) and (b)
Burkett et al. (2005): "The best warm-up for the vertical jump in college age athletic men"	29 football player (speed positions)	a) 5 sub-maximum CMJ by 75% of CMJ. b) 5 weighted jumps with hand barbell 10% of body weight into a box c) Stretching (12 ex. x 20 sec) d) Control group	- JH in CMJ	sig. difference between (b) and the other conditions
McBride et al. (2005): "The acute effects of heavy-load squats and loaded countermovement jumps on sprint performance"	15 NCAA football players	a) 1 set x 3 rep. heavy load squat HS at 90% of 1-RM. b) 1 set x 3 rep. LCMJ at 30% of 1-RM. c) Control group. (4 min for recovery after Treat.)	40 m sprint (10, 30 and 40 m times were measured)	- Subjects ran sig. 0.87% faster after HS in comparison to C - No sig. differences were observed in the 10m or 30m split times between the 3 conditions
Mangus et al. (2006): "Investigation of vertical jump performance after completing heavy squat exercises"	10 men experienced with the squat exercise	a) 4 sets x 1 rep. half-squat at 90% of 1-RM. b) 4 sets x 1 rep. quarter-squat at 90% of 1-RM. c) Control	- JH in CMJ	No sig. difference in JH
Norihiro et al. (2006): "The effects of postactivation potentiation on muscular strength and power"	8 men	a) Half-squats at 40% of 1-RM b) Half-squats at 80% of 1-RM	- JH by loaded CMJ at 30% of 1-RM	No difference between (a) and (b)
Batista et al. (2007): "Intermittent exercise as a conditioning activity to induce postactivation potentiation"	10 physically active men	10 unilateral knee extensions (KE) (every 30 sec) at 60 °/sec in an isokinetic dynamometer	Peak torque was evaluated over the 10 unilateral KE and at the randomized intervals of 4, 6, 8, 10, and 12 min post	Peak torque was potentiated 1.3 (+/-0.79) N x m per unilateral KE, and the potentiation effect persisted for 12 min after the last contraction

Research	Subjects	Treatment	Criteria	Results
Hoffman (2007): "Effects of maximal squat exercise testing on vertical jump performance in American college football players"	64 football players	1-RM in back squat (5 min for recovery)	- JH and peak power in CMJ	Sig. 3% increase in JH and peak power
Hanson et al. (2007): "Acute effects of heavy- and Light-Load squat exercise on the kinetic measures of vertical jumping"	24 men and 6 women	a) 8 rep. at 40% of 1-RM Squats b) 4 rep. at 80% of 1-RM squats (5 min for recovery)	CMJ: - Net impulse. - Time of ground contact. - Normalized peak and normalized minimum vertical ground force.	No sig. Changes observed from pre- to post-testing in either condition
Kato (2007): "Effects of submaximal muscle contraction and stretching on vertical jump performance"	6 men	a) 50% of MVC. b) Stretching. c) Control	- The impulses of 2 CMJ and 2 planter flexion- jump. - Mean power frequency (MPF). - MVC-test.	- Only the impulse of CMJ sig. increased after (a). - MPF increased sig. after (a) - MVC was unaffected by (a).
Saez Saez de Villarreal et al. (2007): "Optimal warm-up stimuli of muscle activation to enhance short and long-term acute jumping performance"	12 trained volleyball players (21-24 years)	a) 3x5 jumps with extra load. b) 2x4 squat with 80% and 2x2 with 85% of 1-RM. c) 2x4 squat with 80% and 2x2 with 90% of 1-RM d) 3x5 DJs e) Specified warm-up for Volleyball f) 3x5 squat with 30% of 1-RM. g) Control	- JH by CMJ with & without extra load - JH by drop-jump-test. - Peak power PP during LCMJ	- No sig differences were observed between warm-up conditions in any of jumps (CMJ, DJ and LCMJ) - JH in DJ, JH in CMJ, and PP in LCMJ sig improved after (a), (b), (c) and (e)
Rixon et al. (2007): "Influence of type of muscle contraction, gender, and lifting experience on postactivation potentiation performance"	15 men and 15 women	a) 3 rep. x 3 sec MVC on Cybex Smith press machine b) Maximal dynamic squat DS on Cybex Smith press machine	JH and peak power PP in CMJ	JH after MVC was sig. higher than DS PP after MVC was sig greater than DS

Research	Subjects	Treatment	Criteria	Results
Rahimi (2007): "The acute effects of heavy versus light-load squats on sprint performance"	12 soccer league players	a) 2 sets x 4 rep. light squats (LS) at 60% of 1-RM. (2 min rest) b) 2 x 4 moderate squats (MS) at 70% of 1-RM (2 min rest) c) 2x 4 heavy squats HS at 85% of 1-RM (2 min rest) d) Control (4 min walking for recovery)	40 m sprint test	- Running speed sig. improved after LS (1.09%), MS (1.77%) and HS (2.98%) in comparison with (d) - When squat protocols were compared, sig. difference was observed between LS and HS only
Chatzopoulos et al. (2007): "Postactivation potentiation effects after heavy resistance exercise on running speed"	15 amateur team game players	Heavy resistance stimulus (HRS): 10 rep. at 90% of 1-RM	Running speed (RS): 30-m dash and the intermediate phase of 0-10 and 0-30 m sprints (3 min prior, 3 and 5 min after HRS)	RS was not affected 3 min after the resistance training, but it increased for both selected running phases (0-10 and 0-30 m) 5 min after the HRS
Kilduff et al. (2007): "Postactivation potentiation in professional rugby players: optimal recovery"	23 professional rugby players	3-RM	Peak power output (PPO) in 7 CMJ and 7 ballistic bench throws: (baseline, after 15 sec, and 4, 8, 12, 16, and 20 min)	- Sig. decrease in PPO for both the upper and the lower body in 15 sec after 3-RM. - Sig. increase in PPO 12 min after 3-RM
Kilduff et al. (2008): "Influence of recovery time on post-activation potentiation in professional rugby players"	20 professional rugby players	3 sets x 3 rep. squat at 87% of 1-RM. Recovery period after Treatment: 15 sec, 4, 12, 20 and 24 min	CMJ (JH, power output, peak rate of force development)	Max. performance was with 8-min recovery period
Weber et al. (2008): "Acute effects of heavy-load squats on consecutive squat jump performance"	12 in-season Division I male track-and-field athletes	a) 5 rep. back squat at 85% 1-RM b) 5 rep. squat jump (SJ)	7 consecutive SJ (mean and peak jump height, mean and peak ground reaction force GRF)	- In (a): mean and peak jump height and peak GRF increased. - In (b) mean and peak jump height and peak GRF decreased.

Research	Subjects	Treatment	Criteria	Results
Yetter & Moir (2008): "The acute effects of heavy back and front squats on speed during forty-meter sprint trials"	10 strength-trained men	(a) Heavy back squat (HBS) at 30, 50, 70% of 1-RM. (b) Heavy front squat (HFS) at 30, 50, 70% of 1-RM. (c) Control. (4 min for recovery)	Average speed during each 10 m interval of 40-m sprint trials	-Sig increase in speed during the 10 to 20m for HBS compared with C. - Sig greater speed during the 30 to 40m by HBS compared with HFS and C.
Khamoui et al. (2009): "Effect of potentiating exercise volume on vertical jump parameters in recreationally trained men"	16 recreationally trained men	a) 2 rep. back squat (85% 1-RM) b) 3 rep. back squat (85% 1-RM) c) 4 rep. back squat (85% 1-RM) d) 5 rep. back squat (85% 1-RM) i) Control (5 min for recovery)	- Vertical jump (VJ) height - Ground reaction force (GRF) - Impulse (IMP), - Take-off velocity (TOV)	- No sig. condition by time interactions for any dependent variable; - Sig. main effects for time for GRF and IMP but not for VJ or TOV
Till & Cooke (2009): "The effects of postactivation potentiation on sprint and jump performance of male academy soccer players"	12 male soccer players	a) Dead lift (5 rep. at 5-RM) b) Tuck jump (5 rep.) c) Isometric MVC knee extensions (3 rep. for 3 sec) d) Control	- 3x10 m and 20 m sprints 4, 5, and 6 min post-warm up - 3 vertical jumps (VJ) at 7, 8, and 9 min post-warm up	No sig. differences in all measurements.
Miyamoto et al. (2010): "Effect of postactivation potentiation on the maximal voluntary isokinetic concentric torque in humans"	9 recreationally active men	a) MVC (10 sec) b) Control	3 max. isokinetic concentric plantar flexions at 180 °/sec (before and immediately after MVC and then every 1-min until the 5-min point, followed by 1 more stimulation at 10 min)	The twitch and concentric torques were potentiated at 0 through 5 min and 1 through 3 min post-MVC. Whereas no sig. difference in the control condition.
Bevan et al. (2010): "Influence of postactivation potentiation on sprinting performance in professional rugby players"	16 professional male rugby players	3 rep. back squat at 91% of 1-RM	5 x 10 m sprints with a 5-m split. (Measurements at baseline, 4, 8, 12, and after 16-min)	No sig. differences in both 5 and 10 m, but when individual responses to PAP were taken into account, a sig. improvement in sprint performance was observed over both 5 and 10 m compared with the baseline.

Research	Subjects	Treatment	Criteria	Results
Farup & Sorensen (2010) "Postactivation potentiation: upper body force development changes after maximal force intervention"	8 strength trained male athletes	5 x1-RM in the bench press	- Isometric rate of force development (iRFD) during an isometric MVC - Maximal power (Pmax) during bench throw	- Sig. decrease in iRFD. - No difference in Pmax
Esformes et al. (2010): "Postactivation potentiation after different modes of exercise"	13 anaerobically trained male	a) 3 rep. half squats using a 3-RM. b) One set of 24 contacts of lower body plyometric exercises. c) Control (5 min for recovery)	- Total and max. displacement - Peak power - Peak vertical force - Rate of force development and relative force	No sig. differences for any of the other variables, but greater displacement in (a) compared to (b) and (c)
McCann & Flanagan (2010): "The effects of exercise selection and rest interval on postactivation potentiation of vertical jump performance"	16 volleyball athletes	a) 5 rep. back squat b) 5 rep. hang clean (both with a load equal to their 5-RM, and then 4 or 5 min for recovery)	JH in CMJ	No differences between exercises or between rest intervals
Linder et al. (2010): "Effects of preload 4 repetition maximum on 100-m sprint times in collegiate women"	12 subjects	a) 4-RM parallel back half-squat b) Control (9 min active rest)	100-m track sprint	Sig. improvement by 0.19 sec in (a)
Berning et al. (2010): "Effect of functional isometric squats on vertical jump in trained and untrained men"	13 resistance trained and 8 untrained Men	a) 5 min of low-intensity cycling b) 5 min of low-intensity cycling plus a 3 sec functional isometric squat with 150 % of 1-RM	JH in CMJ	- Sig. increase at 4 min post-FI squat. This increase was maintained when subjects were retested 5 min - No sig. difference in the untrained group

Analysis of the reviewed studies in table 1

In the previously reviewed investigations, the effects of squat exercise were mostly studied (20 studies). The way of accomplishing the squat was in the majority of cases with the half back squat technique, in a fast rate, moderate or slow rate. Some studies tried to compare the effect of heavy, moderate and light load squats (Hanson et al., 2007; Koch, O'Bryant, Stone, Sanborn, Proulx, Hrubby, Shannonhouse, Boros & Stone, 2003; Norihiro, Akira & Hiduetsugu, 2006; Rahimi, 2007; Saez Saez de Villarreal, González-Badillo & Izquierdo, 2007), or compare various squat repetitions number (Khamoui, Brown, Coburn, Judelson, Uribe, Nguyen, Tran, Eurich & Noffal, 2009) or compare the half squat and the quarter squat technique (Mangus, Takahashi, Mercer, Holcomb, McWhorter & Sanchez, 2006). The variety of intensities, repetitions, number of sets, mode of exercises, recovery time and way of testing in the reviewed studies make the direct comparison of various exercises very difficult. In eleven studies there were significant improvements in performance following squat exercises, which was mostly performed using heavy loads (more than 80 % of 1-RM). In the rest ten studies no effects of squat exercise (in various intensities) were registered. The effect of maximum voluntary contraction, leg press, jumps and weighted jumps, isokinetic force, dead-lift or bench-press were also investigated.

Exercises in which significant improvements in subsequent performances were induced were the MVC in the study of Baudry and Duchateau (2004), in the study of Rixon, Lamont and Bembem (2007) and in the study of Miyamoto, Kanehisa, Fukunaga and Kawakami (2010). However, in the study of Behm, Button, Barbour, Butt and Young (2004) one and two MVCs (ten seconds) did not change maximal force, whereas performance was depressed at ten and 15 minutes after three MVCs. Enhancement in subsequent performances were also registered following weighted jumps into a box (five repetitions with 10 % of body weight) in the study of Burkett, Phillips and Ziuraitis (2005) and the weighted jumps (three sets of five repetitions with optimal load for maximal power output) in the study of Saez Saez de Villarreal et al. (2007). Isokinetic knee extensions (at 60 °/second) in the study of Batista, Ugrinowitsch, Roschel, Lotufo, Ricard and Tricoli (2007) and the functional isometric squat in the study of Berning, Adams, DeBeliso, Sevene-Adams, Harris and Stamford (2010) also showed acute positive effects.

Conclusion: Squats with heavy loads, maximum voluntary contractions as well as weighted jumps with light loads may be able to induce a potentiation in the following performance and thereby they suit to be integrated in the warm-up before training or competition. The recovery times after the activation exercises in studies in which positive effects on the following performances were registered, ranged between no rest (Gourgoulis et al., 2003) and nine minutes (Linder, Prins, Murata, Derenne, Morgan & Solomon, 2010).

2.2 Flexibility

Since about two decades ago the non-energetic properties of muscles, such as flexibility, muscle tone, relaxation and regeneration ability attracted a special attention (Wydra, 2006). The word “flexibility” is derived from the Latin *flectere* or *flexibilis*, “to bend” and defined as the „ability to be bent, pliable” (Alter, 2004). Freiwald (2009) defined the flexibility as the maximum reachable amplitude in a joint.

2.2.1 Flexibility in sport

Each sport type requires a specific level of flexibility. For example an ice-hockey player does not need to reach a large range of motion in comparison to an artistic gymnastic player (Albrecht & Meyer, 2005). Freiwald (2009) compared the normal limits of flexibility between soccer players and ballet dancers and reported that normal limit in soccer players is between 75-105 degrees whereas in ballet dancers is between 125-155 degrees (figure 2).

The adequate level of flexibility for each sport type must allow the athlete to execute all the techniques and tactics of his specific sport type without any limitations (Freiwald, 2009).

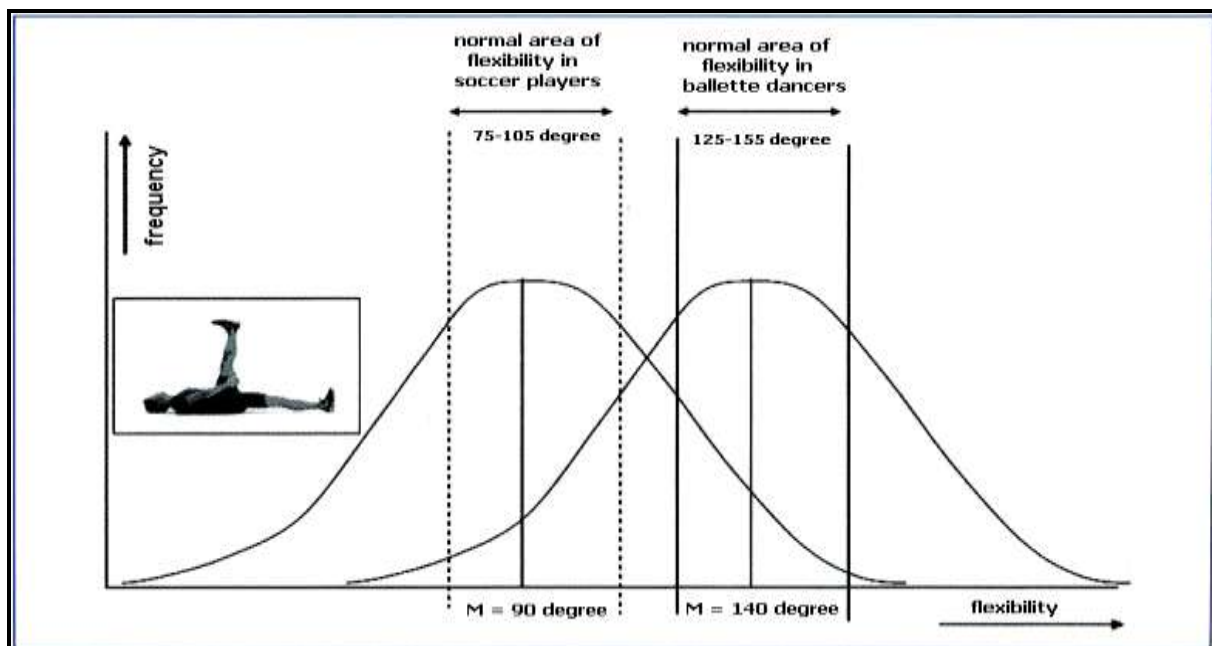

Figure 2: Comparison between normal area of flexibility in soccer players and ballet dancers (adapted from Freiwald, 2009, p. 156).

2.2.2 Factors influence on flexibility

Several anatomical and training-related factors affect flexibility. Anatomical factors such as the joint structure, age and sex cannot be altered through training. On the other hand, training-related factors such as the activity level (increases flexibility), muscle bulk, the resistance training with limited range of motion and the amount of the connective tissues (decrease flexibility) can be altered through training (Jeffreys, 2008).

Grosser, Starischka, Zimmermann and Eisenhut (2008) reported six factors which could influence the flexibility:

- **Age:** The older one gets the more he loses from his flexibility, and the more one cannot improve his flexibility through training. This is caused from the reduction of elastic fibers, decrease of cell number and loss of mucopolysaccharides and water.
- **Gender:** It is well known that flexibility of girls and women is better than flexibility of boys and men. The anatomic differences of joint's forms are the reason of this flexibility differences in addition to that, men normally have a bigger muscle amount than women. This muscle mass blocks the flexibility of joints. Additionally women have a higher Oestrogen concentration which causes more water emplace-ment and a higher percentage of fat.
- **Psychical tension:** The various feelings, affects, fears, joy etc. can increase the psy-
chic tension and this causes muscle hardening and thereby less flexibility.
- **Temperature and warm up:** The surrounding temperature, skin and muscle tem-
perature have an effect on the flexibility.
- **Fatigue:** Intensive loads after a training's work-out or competition cause neural fa-
tigue and increase the muscle tonus and this impairs the flexibility.
- **Daytime:** The flexibility is reduced in the morning after waking up; afterwards the
flexibility will improve again through the day.

2.3 Stretching

Stretching is the systematic application of different stretch-techniques to improve flex-
ibility and other related physiological functions (Blum, 2000). Stretching is commonly
involved in the warm-up in both training and competition situations (Ylinen, 2008).
However, stretching is only one component of warm-up, and both terms are not synon-
ymous as many people think (MacAuley & Best, 2007). In the previous years the
stretching was not so important. Nowadays, a sport-training without integrated stretch
exercises in the warm-up or the cool-down programs is hardly thinkable (Freiwald,
2009).

2.3.1 Anatomy and physiology of stretching

2.3.1.1 Skeletal muscle structure

The skeletal muscle represents the largest organ in the body (about 40% of the total body weight). Each muscle is composed of a great number of subunits and muscle fibers (Edman, 2003). Each muscle fiber is composed of many smaller units called myofibrils. They run the length of the muscle fiber. Each myofibril comprises long, thin strands of serially linked sarcomeres which are the functional unit of a muscle (Alter, 2004).

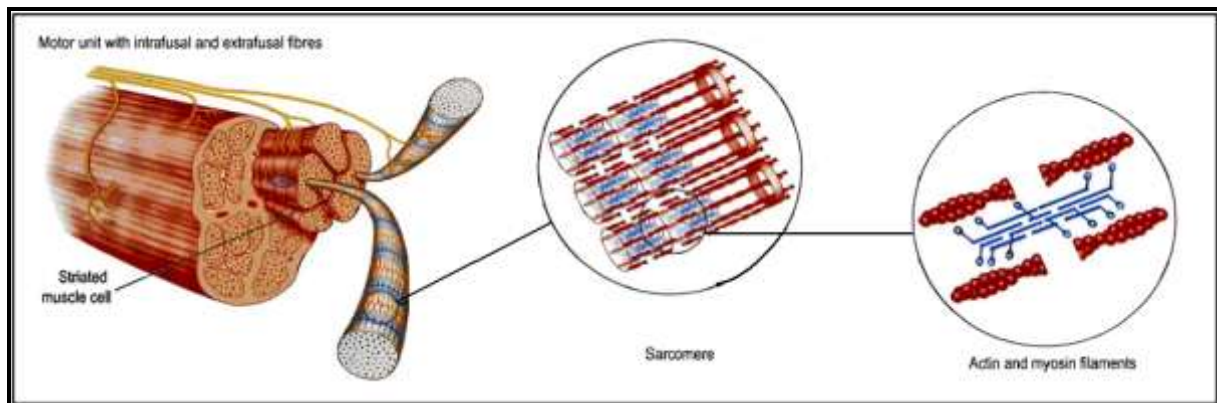

Figure 3: Structure of the muscle (adapted from Ylinen, 2008, p. 34)

The sarcomere consists of longitudinal thick (myosin) and thin filaments (actin) arranged between the so-called Z-discs (Billeter & Hoppeler, 2003) in addition to the titin filament which was later discovered after years of research (Alter, 2004). The sarcomere contract by sliding the thick and the thin filaments past each other, pulling their Z-discs closer together (Billeter & Hoppeler, 2003).

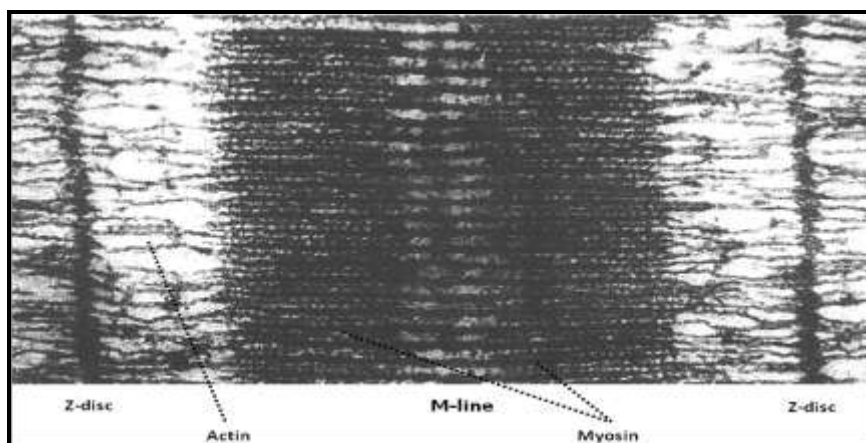

Figure 4: An electro microscopic photo of the Sarcomere (adapted from Klee & Wiemann, 2004b, p. 89)

The so-called I-band abuts the Z-disc and contains the actin filaments, titin filaments and the I-bridge. The A-band corresponds to the length of the thick filament (myosin). The H-zone occupies the centre of each A-band. The size of the H-zone depends on the muscle length or the extent of overlap of the filaments (Alter, 2004). The M-line (M-bridge) is the middle line of the H-zone.

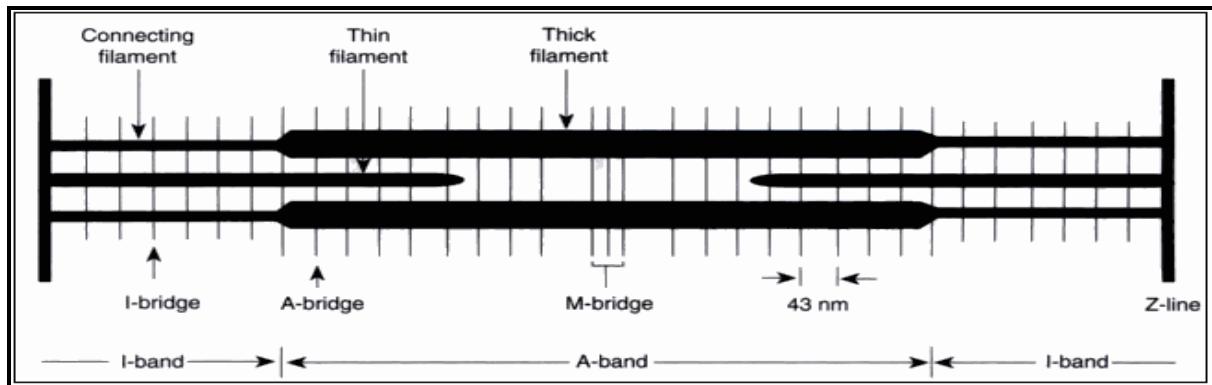

Figure 5: The sarcomere's principal structure (from Alter, 2004, p. 20)

2.3.1.2 Stretching tension

The stretching tension is defined as the passive resistance of the muscle against a force which tries to stretch it (Wiemann, Klee & Stratmann, 1998). When a joint is stretched from an external force (in figure 6: from position 1 to position 3) the origin and the insertion of the muscle go away from each other. The muscle reacts as a rubber against the increased stretching's degree in form of an increased resistance. This resistance increases in a nonlinear way. When the external force goes away, the elastic components restore the original length of the muscle. If the same muscle is stretched, the stretching tension in sub maximum range will be lower, the stretching tension reaches a higher maximum value and the maximum joint range of motion reaches higher value (Klee & Wiemann, 2004b). The higher maximum stretching tension is attributed to the familiarization by improving the one's tolerance to this stretching tension (Klee & Wiemann, 2004b). However, this gain disappears 60-min after the last stretch exercise (Magnusson, Simonsen, Aargaard & Kjaer, 1996, as cited in Klee & Wiemann, 2004b). Furthermore, long-term stretch programs do not reduce the stretching tension. However, the maximum joint range of motion can increase up to 15 % because of the improvement of one's tolerance to stretching tension (Klee & Wiemann, 2004b).

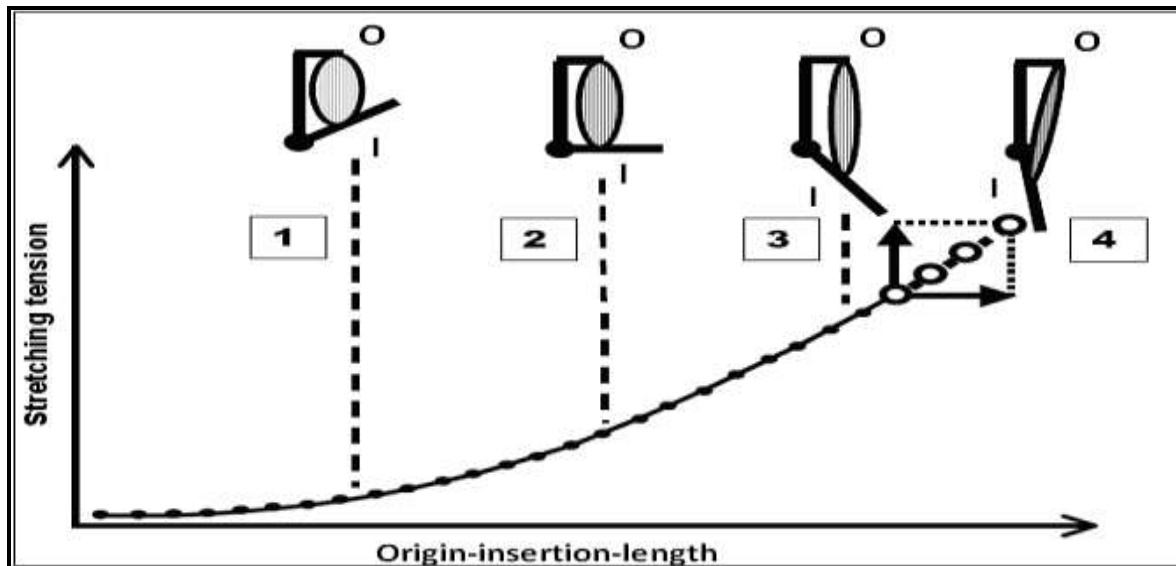

Figure 6: Stretching tension curve of a muscle. O: muscle origin, I: muscle insertion (adapted from Klee & Wiemann, 2004b, p. 93)

2.3.1.3 Titin filaments

Until the beginning of 90th decade it was thought that the contractile filaments (actin and myosin) and the parallel connective tissues produce the stretching tension of the muscles. With the new research techniques the titin filament was discovered, which is responsible for the major part of resting and stretching tension (Freiwald, 2009). If the titin filaments are removed from the sarcomere through chemical processes without impairing other structures then the muscle fibers lose their stretching tension (Klee & Wiemann, 2004b). Neither actin nor myosin are being stretched (Freiwald, 2009).

Titin filaments have many functions, they provide stability for the sarcomere by keeping the myosin filaments in the centre within the sarcomere (see figure 7), and they provide the elasticity of the muscle by nearing the myosin filament to the Z-disc again following a stretching of the sarcomere and thereby the original sarcomere length can be restored (Klee & Wiemann, 2004b). Additionally, titin filaments prevent localized overstretch of the myofibril during isometric contractions and thereby ensuring the uniform sarcomere length (Goulding et al., 1997, as cited in Alter, 2004, p. 24). Titin filament has the ability to store the elastic energy and then to release it (Freiwald, 2009). Every myosin filament has a constant number of titin filaments. When the cross section of the muscle grows (hypertrophy), the number of the myosin filaments and their titin filaments increase, and thereby the elastic resistance of the muscle increases. Therefore, strength training could cause more elastic resistance in the passive muscles (Klee & Wiemann, 2004b).

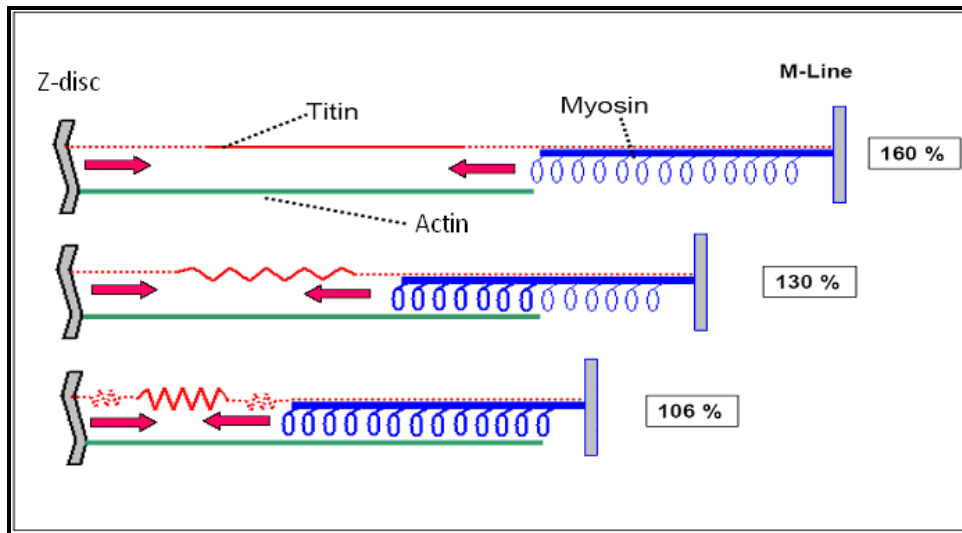

Figure 7: The force of titin filaments works to restore the original length of sarcomere and the extent of overlap of actin and myosin filaments of a half sarcomere in three stretching degrees (adapted from Klee & Wiemann, 2004b, p. 92)

2.3.1.4 Stretching of other structures

When a muscle is stretched, not only the contractile parts of the muscle are being stretched, but rather tendons, muscle-tendon-junctions, tendon-bone-junctions and the connective tissues inside and outside the muscle (figure 8) are under stretching tension (Freiwald, 2009).

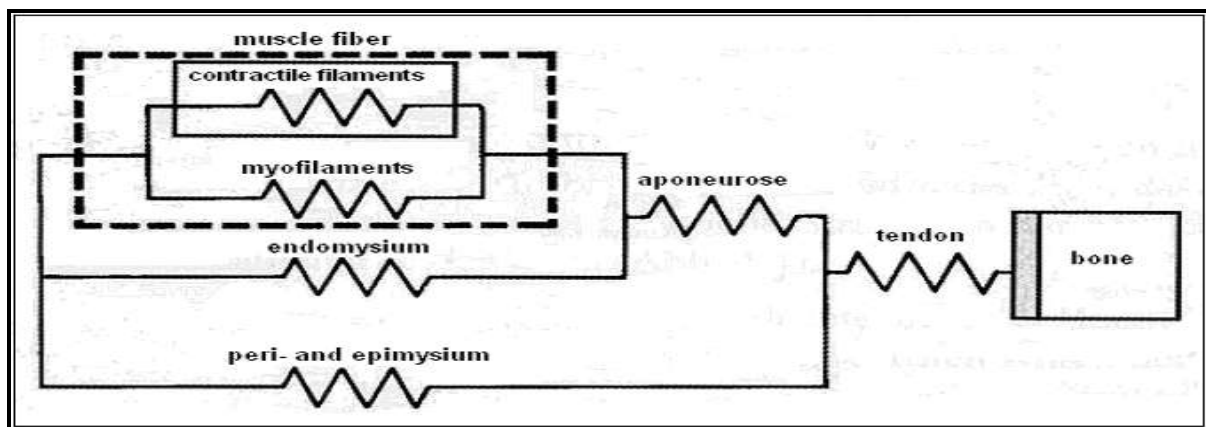

Figure 8: Stretching tension on muscle fiber, tendons, muscle-tendon-junctions (aponeurose), tendon-bone-junctions and connective tissues inside (endomysium perimysium and epimysium) and outside the muscle (adapted from Freiwald, 2009, p. 39, modified from Freiwald, 2007; from Huijing, 1994; in Komi, 1994, p. 149).

It is not fully clear how large is the amount of resistance (stretching tension) which is caused from the connective tissues that surrounds the muscle from inside and outside, the so-called “fascia”. In animal experiments it was found out that just in extreme stretching position the fascia causes resistance (Magid & Low 1985, as cited in Freiwald, 2009, p. 40).

Freiwald (2009) reported that in intact muscles we can disregard the stretching resistance that caused from the fascia as long as the stretch is still in a stretching physiologic range (up to approximately 160 % of the original length of a muscle). Despite this fact, some authors gave it a weighty role in the amount of stretching resistance.

2.3.1.5 Stretching and changes in muscles length

Only in animal experiments it is possible to exactly measure the sarcomere’s number after finishing the experiment, and measure if an increase occurred in sarcomere number in the muscle’s longitudinal direction. The transfer from animals’ results into humans is problematic. The muscle length of a living human can merely indirectly be measured (Freiwald, 2009; Wydra, 2006; Wydra & Glück, 2004). The optimal muscle length is normally used as an indirect indicator for the muscle length in humans. Developing a maximum force of a muscle depends on the extent of overlap of actin and myosin filaments. When the actin and myosin filaments overlap optimally in a middle stretching degree, the number of cross-bridges reach its maximum and thereby a maximum contraction force can be developed (see figure 9). This muscle length in which the maximum force can be developed is called “optimal length”. The more the muscle strews from its optimal length, the less is the overlap of actin and myosin filaments and the smaller is the contraction force (Klee & Wiemann, 2004a). If an increase in muscle length would occur following a stretch program, a consequence of alternation would occur in the optimal muscle length in which the maximum force developed (Wydra & Glück, 2004; Wydra, 2006).

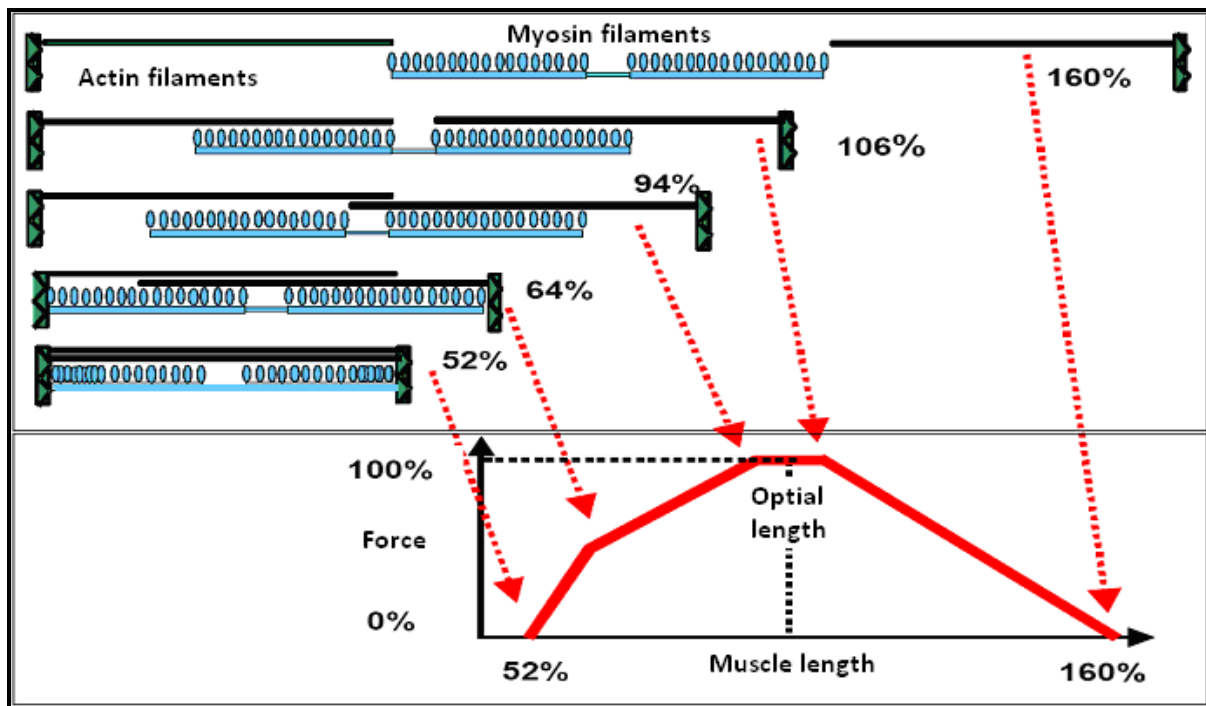

Figure 9: The force-length-curve in relation to the varied overlap extent of myosin and actin filaments in a half sarcomere (adapted from Klee & Wiemann, 2004a, p. 3).

Wiemann and Leisner (1996) compared between gymnasts and sport students and reported no differences between the two groups in regard to force-length-relation (optimal length) of the hamstring, despite the fact that the gymnasts generally have better flexibility in hip joint than sport students. They attributed their results to the daily inclusion of muscles in the walking and running at the same joint degree in both groups. In another study, Wiemann (1994) reported no changes in muscle length (through the indicator of optimal length) after 10 weeks of stretching programs. Klee and Wiemann (2004b) summarized that an intensive stretch program can not alter the optimal length of a muscle. The optimal length is related to the joint's sector in which the daily work occurs, and when no long-term alternation of daily work degree of a muscle occurs, the muscle length remains constant.

2.3.2 Types of stretching

Nowadays, there are many types of stretching, so that it is hardly to overlook all of them (Freiwald, 2009). However, many authors reported five major types (techniques) of stretching (Klee & Wiemann, 2004a; Wydra, 2006; Freiwald, 2009): dynamic stretching, static stretching and proprioceptive neuromuscular facilitation stretching which also has three types: agonist contract, contract-relax and contract-relax agonist contract stretching.

2.3.2.1 Static stretching (SS)

Static stretching has been widely spread after the releasing of the book “Stretching” from Anderson (1980) who released the static stretching to the world. The purpose of this stretch is to improve the flexibility without activating the stretch-reflex (Grosser et al., 2008). In this type of stretching the body part is slowly moved to a position where the muscle is perceptibly gently pulled, and then this position will be held for a certain duration (Albrecht & Meyer, 2005). The end position is reached when a light pull-tension (light pain) in the muscle is perceptible (Grosser et al., 2008).

Freiwald (2009) classified three static stretching in regard to the duration of holding the stretch:

1. Short duration static stretching (10 - 15 seconds).
2. Middle duration static stretching (up to 60 seconds).
3. Long duration static stretching (more than 60 seconds).

The first and second stretch-durations are used in sport; the third is normally used in the therapy (Freiwald, 2009).

Albrecht and Meyer (2005) categorized three forms of static stretching:

1. Progressive-static stretching: in this stretch the position will be furthermore deepened when the intensity of stretching (stretch-tension) reduced.
2. Shifted-static stretching: in this stretch the position is held for five to nine seconds, then a small variation of joint's angle of the stretched part of body will be done, and then the new position will be held for another five to nine seconds.
3. Stiff-static stretching: in this stretch the position is held along the whole stretch.

Blum (2000) differentiated between passive and active static stretching:

1. Passive static stretching: The muscle in this stretch type is slowly stretched to the achievable end position, without any pains or uncomfortable feeling, and then this position will be held for 10 – 30 seconds. When the stretch-tension is clearly reduced after approximately 2 – 4 seconds during the stretching that means that the stretch intensity is correctly adjusted. The stretch will be followed by a rest that persists the same duration of stretching, and during this pause the antagonist muscle group could be stretched.
2. Active static stretching: This is one of the youngest stretch methods and therefore it is not well known. In this type, the muscle will be slowly stretched to the achievable end position just like the passive static stretching, and then the antagonist muscles will be actively tensed for 10 – 20 seconds.

Advantages of static stretching

- Less injury risk, no stretching-reflex activation, the raising of discharging frequency of Ia fibers is avoided and static stretching needs less energy than dynamic stretching (Grosser et al., 2008).
- Better dosage of load on tissues than dynamic stretching, psychic relaxation during stretch-execution (Freiwald, 2006).
- Improves the mood (Schneider & Wydra, 2001).
- Well-controlled stretching, the experienced athletes can assess actual function status of their muscles and joints (Freiwald, 2009).

Disadvantages of static stretching

Grosser et al. (2008) reported the following disadvantages of static stretching:

- Extra load on capsule-string apparatus through the long hold in stretch position.
- The inter-muscular coordination is disregarded through the isolated stretch of muscle.
- Low local blood circulation progress and therefore no positive warm-up-effects are expected.

Wydra (2003) reported that the static stretching underlies the other stretch techniques in both short- and long-term effects in regard to the improvement of flexibility.

2.3.2.2 Dynamic stretching (DS)

Up to the beginning of the 90s years, the dynamic stretching was considered as an unsuitable way to improve the flexibility and it was recommended to use the static stretching and avoid the dynamic stretching (Wydra, 2006). Anderson (1980) not only propagated for the application of static stretching, but he also censured the dynamic stretching (Freiwald, 2009). However, many experiments, for example Wiemann (1991); Wydra, Bös and Karisch (1991) and Wydra, Glück and Roemer (1999) reported that dynamic stretching could bring more effects on flexibility than other stretching types.

In this type of stretching the muscles are widely stretched as much as possible through swinging movements (Grosser et al., 2008). The dynamic stretching must be performed rhythmically (Freiwald, 2006). The swinging movements vary from small to large movement amplitudes, and from low to high frequency movements (figure 10). The end position of joints is being reached either actively through the contraction of the agonists or passively through the application of external forces (gravity, partner) (Grosser et al., 2008).

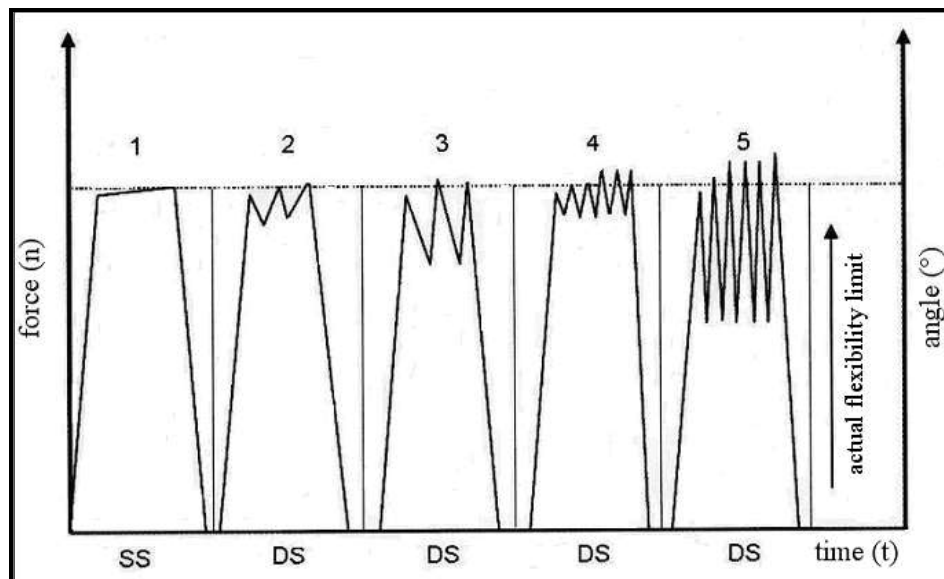

Figure 10: Variations of static and dynamic stretching: 1. static stretching (SS) with slower joint-amplitude expansion. 2. Dynamic stretching (DS) with small movement-amplitudes. 3. Dynamic stretching (DS) with larger move-amplitudes. 4. Dynamic stretching (DS) with higher frequency and small movement-amplitudes. 5. Dynamic stretching (DS) with higher frequency and high movement-amplitudes (adapted from Alter 2004, p. 159; originally adapted from Zachazewski, 1990)

The difference between static and dynamic stretching is smaller if the swinging movements during dynamic stretching are performed in a low velocity and small amplitude (Wydra, 2002)

Advantages of dynamic stretching

- Klee and Wiemann (2004a) summarized some arguments for the rehabilitation of dynamic stretching:
 - Neither static nor PNF-stretching cause a reduction in the stretch reflex in comparison to dynamic stretching.
 - The possibility of injuries by dynamic stretching with moderate velocity and moderate swinging amplitude is also low as by other stretches.
 - In the dynamic stretching the antagonists will be strengthened, and the muscle temperature will be higher through the improvement of blood circulation, this makes the dynamic stretching suitable in the warm-up phase.
 - Dynamic stretching is similar to many of dynamic loads in the praxis, for example hurdling.
 - Some exercises must be done with dynamic stretching because there is not enough force to produce an intensive stretching with the static stretching.

- Dynamic stretching could sometimes improve the range of motion better than the static stretching.
- Other advantages reported by other authors:
 - Dynamic stretching causes no reduction in force or power when it is done direct in the warm-up (Begert & Hillebrecht, 2003).
 - Dynamic stretching improves the inter- and intramuscular coordination, improves the local blood circulation of the stretched muscles and the antagonist could be strengthened through an active dynamic stretching (Grosser et al., 2008).
 - Contrary to static stretching, the dynamic stretching is suitable for the preparation (in the warm-up phase) before an athletic load or competition, especially when the following movement requires a large range of motion (Freiwald, 2006; Freiwald, 2009).
 - Contrary to static stretching, in dynamic stretching the end position of joints is not fixed (Freiwald, 2006).
 - The tissues-stress caused from dynamic stretching has biopositive adaptations, so that the tissues will be firmer and tolerate higher load (Freiwald, 2006).
 - Dynamic stretching is well suitable to enhance the flexibility (Wydra et al., 1991; Wydra et al., 1999).

Disadvantages of dynamic stretching

- Activates the stretch-reflex (Grosser et al., 2008).
- Frequent application of dynamic stretching raised the risk of injuries (Beaulieu, 1981, as cited in Höss-Jelten, 2004).
- Short stimulus duration and small stimulus volume: the end position of joints is being reached just for a short period. Therefore, neither creeping effect nor relaxation happen (Grosser et al., 2008).
- The application of dynamic stretching after injuries must be carefully used, because the tolerance of tissues could be exceeded through the dynamic stretching (Freiwald, 2006).

2.3.2.3 Contract-relax-stretching (CR)

This type of stretching is also called as proprioceptive neuromuscular facilitation (PNF) stretching, contract-hold-relax-stretching (CHRS) or post isometric relaxation stretching (PIR) (Freiwald, 2009). The contract-relax-stretching is a special form from passive static stretching and come from the physiotherapy (Albrecht & Meyer, 2005). In this type of stretching the muscles are first isometrically contracted for two to ten seconds (with sub-maximum or maximum intensity), then the muscles will be relaxed

for a while, then the stretch position will be taken, and then the previously contracted muscles will be static stretched. Either self- or external-stretching could be used for the stretch (Freiwald, 2009). The combination of muscle contraction and stretching is used to maintain muscle tone through relaxing the muscles (Nelson & Kokkonen, 2007).

Advantages of contract-relax-stretching

- The muscle activity is reduced immediately after the isometric contraction, and that reduced the tension of the muscles against the following stretch, therefore, contract-relax-stretching is recommended to improve the flexibility (Albrecht & Meyer, 2005).
- Better blood circulation and strengthening the muscles and optimizing the own body feelings through the isometric contraction. This type of stretching has a lot of advantages for athletes as well as patients (Freiwald, 2009).

Disadvantages of contract-relax-stretching

- This type of stretching has the same disadvantages of static stretching (Höss-Jelten, 2004).
- Not well suitable for beginners (Kunert, 2008; Höss-Jelten, 2004).

2.3.2.4 Agonist-contract-stretching (AC)

This stretch is also called “PNF-stretching”. In this type of stretching the athlete stretches actively (through an agonist contraction) until the joint’s end position are being reached, then this position will be held for a while (< 10 seconds) (Freiwald, 2009). The principle of this stretch is the cooperation between the agonist and antagonist. During the agonistic contraction and stretching, the antagonists are being statically stretched (Kunert, 2008).

Advantages of agonist-contract-stretching

Kunert (2008) reported the following advantages of AC-stretching:

- A very good method to improve the flexibility, especially the active flexibility.
- Improves the blood circulation and the strength of the agonist muscles.
- Suitable for the preparation (in the warm-up) before training or a competition.
- Improves the strength in addition to the improvement of the flexibility.

Disadvantages of agonist-contract-stretching

- It needs experience, and much body feelings (Kunert, 2008).
- Good co-ordination and concentration are also needed (Freiwald, 2009).

2.3.2.5 Contract-relax- agonist-contract-stretching (CR-AC)

This stretch is also called “PNF-stretching” (Freiwald, 2009). In this type of stretching the muscles are being first isometrically contracted and then the same will be done as in the agonist-contract-stretching (Freiwald, 2009).

Advantages and disadvantages of (CR-AC)

The advantages and disadvantages of this type are the same as of the contract-relax and agonist-contract stretch types (Freiwald, 2009).

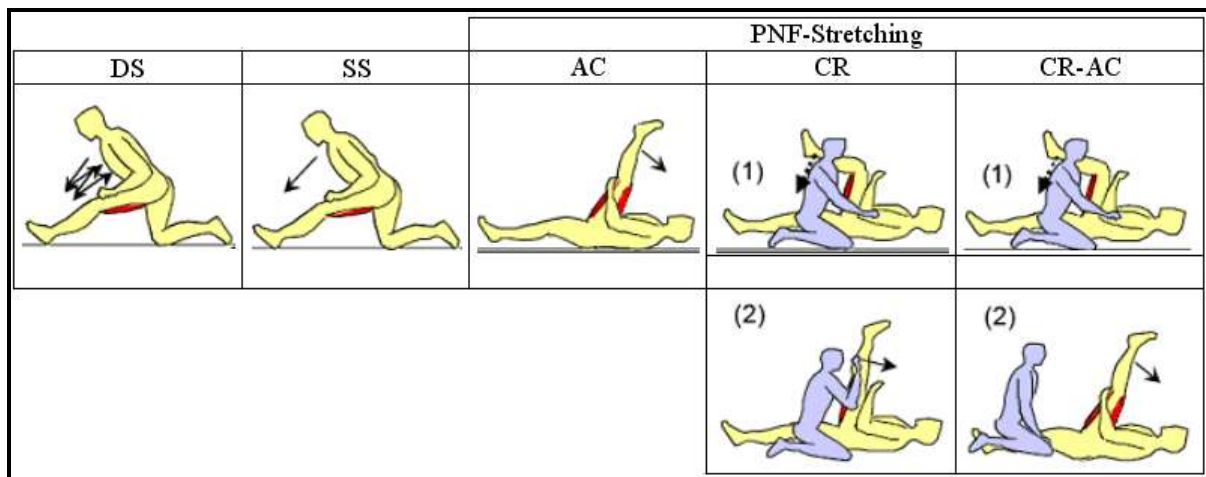

Figure 11: Five types of stretching: dynamic stretching (DS), static stretching (SS), agonist contract (AC), contract-relax (CR) and contract-relax agonist contract stretching (CR-AC) (adapted from Klee & Wiemann, 2004a, p. 11)

2.3.3 Evaluation of stretch-types according to their efficiency in improving flexibility

Before evaluating the several types of stretching, it is very necessary to recognize the various durations in which the stretching is performed and their effects (Wydra et al., 1999). Wydra (2003) differentiated between three stretch-durations of performing the stretch: singular-, short-term- and long-term-stretching:

1. Singular stretching: Just a few numbers of repetitions of stretches are being performed.
2. Short-term stretching: A stretch program for 15 - 30 minutes is being performed.
3. Long-term stretching: Training's program will be performed for several days or weeks.

This leads to differentiation between three stretching's effect types: short-term, middle-term and long-term effects.

Wiemann (1994) categorized just two stretching's programs in regard to the duration of stretch-exercises:

- Short-term stretching (10 - 20 minutes of stretch-exercises) for one or for a group of muscles, for example the stretch-program in a warm-up phase. Immediately, minutes or up to one hour following performing a short-term stretch program causes the so-called "acute effects".
- Long-term stretching for many weeks (a short-term stretching are performed, daily or every three days at least). After weeks of stretching, many training's adaptations are expected and this will be called "long-term-effects".

Several studies tried to compare the effects of various types of stretching. However, the experimental conditions in these studies were not standardized because of the variety of subjects, intensity, stretch duration and execution way. In the most of cases there was no control group. Therefore, it is not easy to compare the various types of stretching and the results cannot be scientifically interpreted (Freiwald, 2009).

Nevertheless, Klee and Wiemann (2004a) could make a meaningful evaluation of 28 empiric studies. They ranked the five major types of stretching according to their efficiency in improving the flexibility (see table 2). He divided the studies in four groups in regard to short- and long-term effects, and in regard to the way of testing the flexibility whether passive or active. The evaluation showed that all the stretch-types improve the flexibility. However, CR-AC stretching is the best of all, and static stretching is the worst of all.

Table 2: Efficiency of five types of stretching in improving the flexibility (adapted from Klee & Wiemann, 2004a, p. 13).

stretch-effect	way of testing	1	2	3	4	5
1. short-term	passive	AC	CR-AC	DS	CR	SS
2. short-term	active	CR-AC	AC	CR,DS		SS
3. long-term	passive	CR-AC	CR	DS	SS	AC
4. long-term	active	CR-AC	DS	AC	SS	CR
summary						
5. short-term	1+2 (passive+active)	CR-AC	AC	DS	CR	SS
6. long-term	3+4 (passive+active)	CR-AC	DS	AC,CR		SS
7. all studies	all	CR-AC	AC	DS	CR	SS

2.3.4 Active-passive vs. self-external stretching

The categorization of stretching to active or passive was differently defined (Glück, Schwarz, Hoffmann & Wydra, 2002). Maehl (1986) reported that an active stretching includes no utilization of body weight or help from a partner, but the stretch will be executed through the activity of one’s muscles. In the passive stretching the stretch is executed through the impact of external forces, and the direct antagonist muscles are inactive (Maehl, 1986; as cited in Glück et al., 2002, p. 67). Wydra, Bös & Karisch (1991) and Wydra (1997) differentiated between the active and passive stretching that in the active type the movement execution will be done without a helper, while the movement execution will be done with a helper. For more than three decades there was criticism in the terminology of the expressions of active and passive stretching. These expressions do not reflect the fact exactly because the passive stretching also contains active components (the relaxability of the antagonist) (Wydra et al., 1999; Glück et al., 2002). Therefore, Wydra et al. (1999) suggested a new categorization of stretching. Their categorization is based on whether the athlete stretches himself, or the athlete is being stretched through an external force (see figure 12). In the self-stretching (through agonist muscles, other muscles or own body weight) the athlete has directly unlimited ability for the sensomotoric proceeding regulation through the kinesthetic feedback from the stretched muscles and from the muscles which are used for this stretch. In the external stretching (through a partner or a machine) there is merely an indirect ability to dosage the volume, intensity and duration of stretch. A proceeding regulation in a stretch under narcosis is deactivated (Wydra et al., 1999).

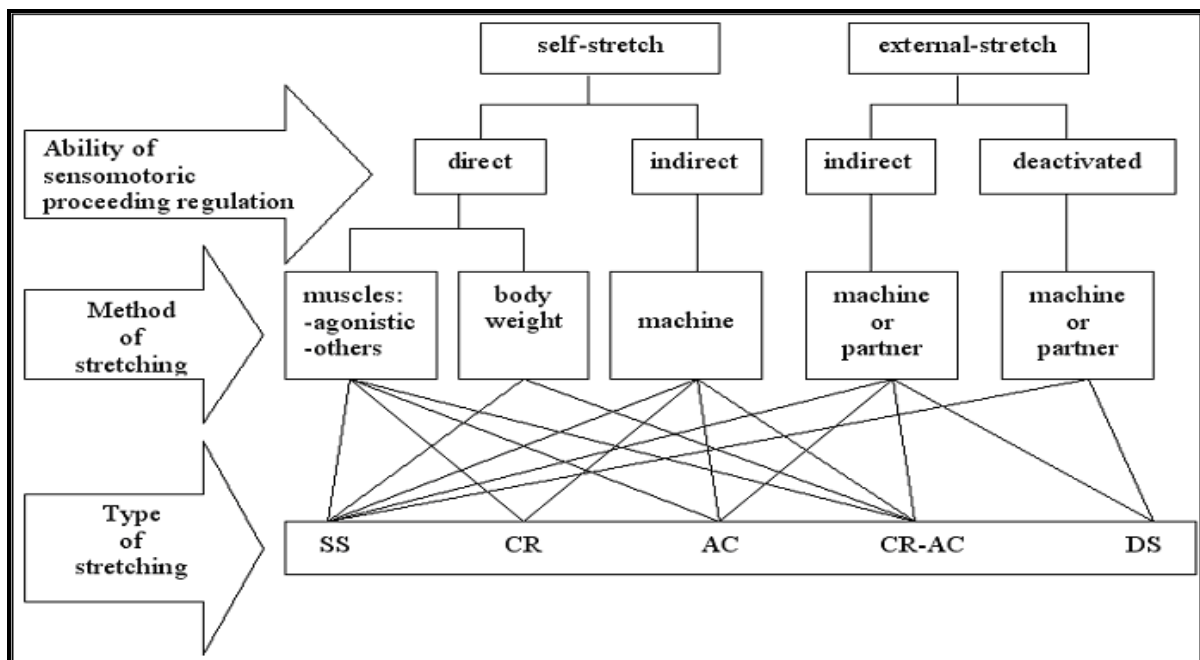

Figure 12: Categorization to self or external stretching (adapted from Wydra et al., 1999, p. 256)

Glück et al. (2002) compared between three stretching-concepts in regard to the maximum reachable range of motion, stretching tension at constant angle, greatest tolerated stretching tension and muscle activity of the M. biceps femoris. They developed a stretching-measure-sledge that consists of a plate that lies on small wheels. The stretching tension was measured using a stretch-measure-sensor and the range of motion was measured with a goniometer. The subjects were divided into three groups and they performed the following three test protocols in separated times and in a randomized order: test (1): direct self-stretching by independent stretching using a rope; test (2): indirect self-stretching in which the test person controlled a motor and test (3): indirect external-stretching, in which the examiner operated the motor. Their results showed that maximum reachable range of motion was 5 % significantly higher in the direct self-stretching than the other stretches. However, there were no significant differences in the other parameters.

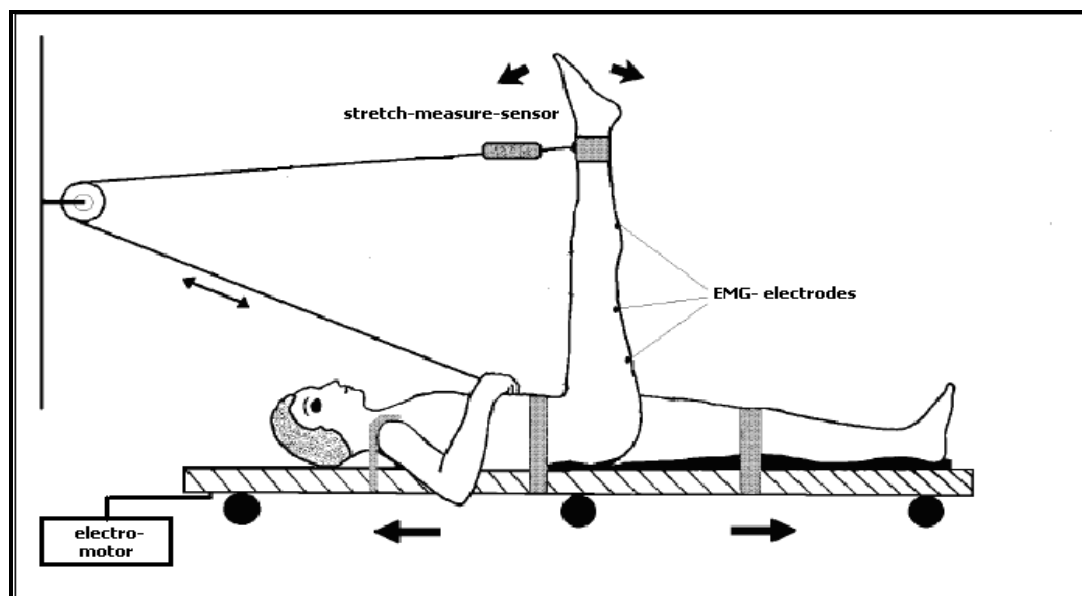

Figure13: Stretching-measure-sledge (adapted from Glück, 2005, p. 63)

Additionally, Glück et al. (2002) investigated how many repetitions are enough to improve the range of motion and reduce the stretching tension. They found that a large improvement in range of motion and a huge reduction of stretching tension occurred after the first four to five repetitions and then the gain was reduced from repetition to repetition. Wydra and Glück (2004) summarized that four to five repetitions of stretching or for less than ten seconds are enough to reduce the stretching tension and to enhance the range of motion. This avoids the unnecessary long stretching which may cause muscle soreness or a reduction in power performance (see figure 14). Glück et al. (2002) also reported that self-stretching method is more effective than external-stretching.

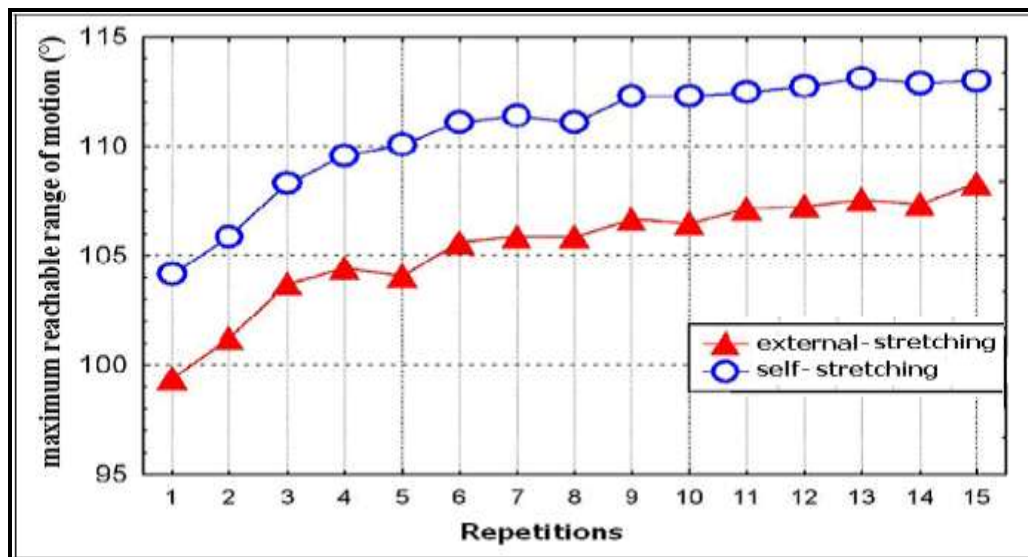

Figure 14: Change in maximum reachable range of motion in relation to the number of repetitions and the stretch-method (adapted from Wydra & Glück, 2004, p. 111).

2.3.5 Acute effects of static stretching

Static stretching is often practiced as an important part of warming-up in order to improve athletic performance and/or to reduce the possibility of muscular injuries and muscular soreness (Rubini, Costa & Gomes, 2007).

2.3.5.1 Static Stretching and reducing the risk of injuries

It is generally accepted that increasing the flexibility of a muscle-tendon unit reduced the risk of injuries (Witvrouw, Mahieu, Danneels & McNair, 2004). However, the empiric verification of this allegation is very difficult (Wydra, 2006).

Shrier (1999) reviewed a number of basic science literature and suggested five reasons why stretching before exercise would not prevent injuries:

“First, in animals, immobilization or heating-induced increases in muscle compliance cause tissues to rupture more easily. Second, stretching before exercise should have no effect for activities in which excessive muscle length is not an issue (e.g., jogging). Third, stretching won't affect muscle compliance during eccentric activity, when most strains are believed to occur. Fourth, stretching can produce damage at the cytoskeleton level. Fifth, stretching appears to mask muscle pain in humans”. (Shrier, 1999, p. 221)

Herbert and Gabriel (2002) evaluated the study of Pope, Herbert and Kirwan (1998) as well as Pope, Herbert, Kirwan and Graham (2000). A total of 2630 army recruits were divided in two groups. The first group (1284 test persons) performed stretches for two to four minutes before undergoing military training, while the second group (1346 test persons) underwent military training with no stretches (control). During 12 weeks, 181 injuries occurred in the stretch group, and 200 injuries occurred in the control group.

As shown in figure 15, Survival curves for stretch and control groups were similar. Their analysis of both studies suggested that muscle stretching before exercising does not produce meaningful reductions in the risk of injury (Herbert et al., 2002).

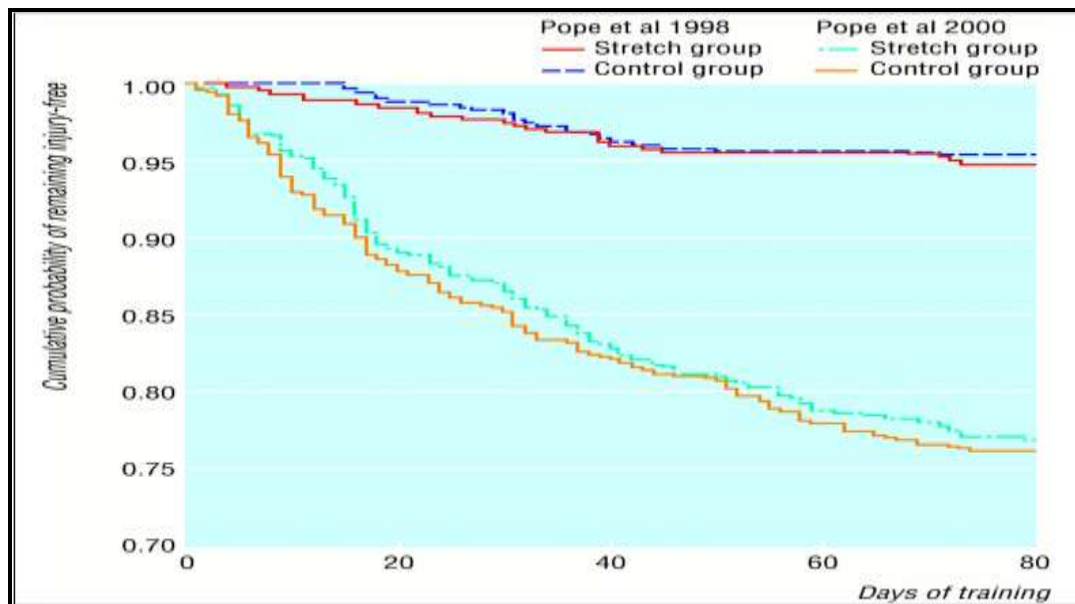

Figure 15: Survival curves from the studies of Pope et al. (1998) and Pope et al. (2000), showing risk of injury in army recruits undergoing training (from Herbert & Gabriel, 2002, p. 471).

Hart (2005) analyzed five controlled studies and reported that no reduction in total injuries (shin splints, tibial stress reaction, sprains/strains, and lower-extremity and -limb injuries) with either stretching of specific leg-muscle groups or multiple muscle groups.

On the other hand, Klee (2006) reported that most of researches which investigated the effects of stretching in preventing injuries had not differentiated between the various types of injuries. Not all types of injuries are expected to be reduced as a result of stretching. Just muscle strain and torn muscle fiber could be reduced following stretching, whereas fewer effects can be expected in the injuries in other structures such as the ligaments, synovial bursa, joints and bones as well as the overload damages. For this reason, many of meta-analyses lose their meaning, such as the famous study of Herbert and Gabriel (2002). Merely two studies (Cross & Worell, 1999; Dadebo, White & George, 2004, as cited in Klee, 2006) investigated the effects of stretching on injuries in muscle strain. The results revealed reductions in such injuries; however, it was not possible to differentiate if these reductions in injuries were attributed to short-term or long-term effects of stretching (Klee, 2006).

Conclusion: Further investigations are required for the judgment about the effectiveness of stretching in reducing injuries.

2.3.5.2 Static Stretching and reducing muscle soreness

The delayed-onset muscle soreness (DOMS) occurs mostly after unusual movements, intensive load (tests, competitions), coordination's training and training after injury or after a training's vacation (Wick, 2009). DOMS also occurs after movements with eccentric contractions (such as downhill running) and particularly with bad coordination, and rarely by intensive continuous load (Böning, 2000). DOMS is characterized by a prolonged loss of strength, reduced range of motion and elevated levels of creatine kinase in the blood, and usually reaching a peak 24 to 72 hours after strenuous exercise (Miles & Clarkson, 1994). The pain is produced from autolysis of destroyed muscle fibers (figure 16), swelling and partly inflammation (Böning, 2000). The lactic acid is not responsible for DOMS as commonly known. Wiemeyer (2002) reviewed six researches in which the effects of stretching on reducing muscle soreness were studied and he reported no effect on delayed onset muscle soreness. Similarly, in the review of Herbert and Gabriel (2002) a clear evidence from five studies was found that stretching before or after exercising has no effect on DOMS. Furthermore, stretch-exercises could by itself cause muscle soreness (Smith, Brunetz, Chenier, McCammon, Houmard & Franklin, 1993; as cited in Klee & Wiemann, 2004a, p. 8).

Conclusion: A positive effect of stretching on reducing the delayed onset muscle soreness is not expected.

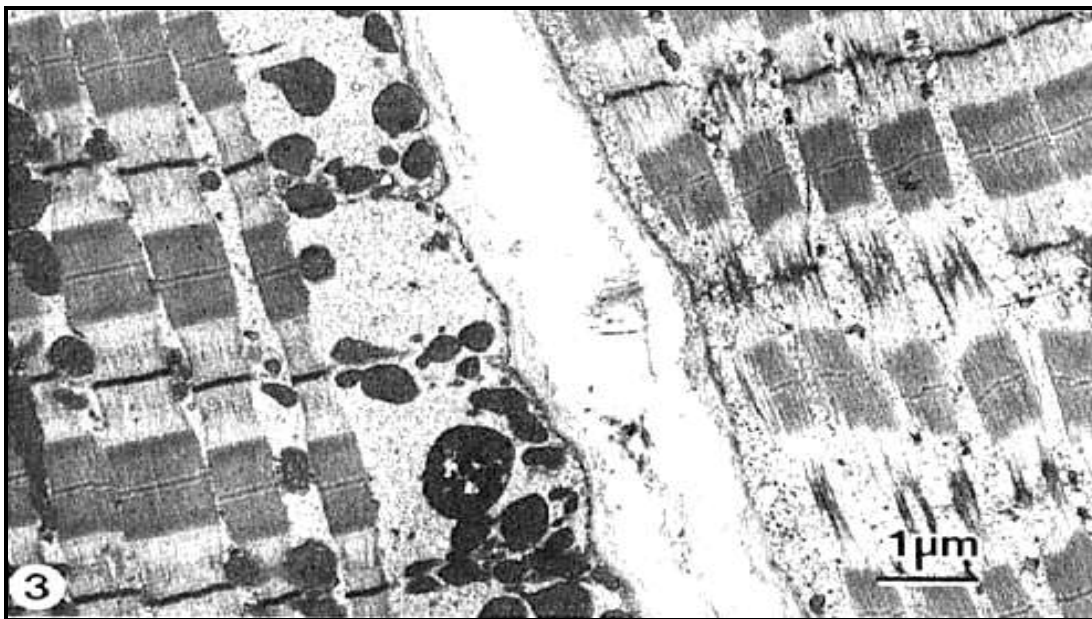

Figure 16: Electron micrograph showed the delayed-onset muscle soreness. The sarcomere in the left fiber is completely intact, in the right fiber the Z-disk is destroyed (the thick black lines), Original magnification x 13500, (from Böning, 2000, p. 63; originally adapted from Fridn, Sjöström & Ekblom, 1983).

2.3.5.3 Static stretching and athletic performance

A number of recent investigations reported a temporary reduction in force, power and sprint performance following static stretching. On the other hand there are a lot of investigations in which no significant changes occurred after an acute bout of static stretching. Shrier (2004) reported in a systematic review to the acute effects of stretching on the force, torque, power, jump and sprint performance the following: There were no studies that suggested that stretching has a positive effect on performance. There were 20 studies in which acute decreases in force, torque, power and jump performance were registered. There was a decrease in muscle activity (EMG) in four studies and in one study there was no change. For sprint time the results were contradictory. One study showed a detrimental effect of stretching and the other showed beneficial effect, another two studies had equivocal results and one study reported an improvement of running economy. The conflicting results were explained by the different methods (duration, intensities and volumes) used for stretching (Rubini et al., 2007), the number of participated subjects or the absence of a control group.

2.3.5.4 A recent review to the acute effects of static stretching on performance

A number of recent studies were summarized in this review. Pub-med and the electronic journals library of Saarland University were searched for all articles related to the acute effect of static stretching. A detailed summary for each study can be found in tables 3 and 4.

Table 3: A review of researches in which an acute effect of static stretching on force, torque and jump performance was found.

Research	Subjects	Treatment	Criteria	Results
Hennig & Podzielnny (1994): “Die Auswirkungen von Dehn- und Aufwärmübungen auf die Vertikalsprungleistung”	46 subjects	Static stretching: 12 ex. x 20 sec	- CMJ	Sig. decrease in JH (-4%)
Avela et al. (1999): “Altered reflex sensitivity after repeated and prolonged passive muscle stretching”	20 subjects	Passive static stretching: 1 hour for triceps surae	- MVC (plantar flexion)	- Sig. decrease in MVC (-23.2%) - MVC values were recovered after 15-min
Fowles et al. (2000): “Reduced strength after passive stretch of the human plantarflexors”	10 subjects	a) Static stretching (13 stretches for 30-min, intensity: maximally tolerable passive stretch) b) Control	- MVC (plantar flexion) (pre, post, 5, 15, 30, 45 and 60-min after static stretching)	- Sig decrease in MVC at Post (-28%) and at 5 (-21%), 15 (-13%), 30 (-12%), 45 (-10%), and 60 min (-9%) after static stretching
Young & Elliott (2001): “Acute effects of static stretching, proprioceptive neuromuscular facilitation stretching, and maximum voluntary contractions on explosive force production and jumping performance”	14 males	Static stretching (3 rep. x 15 sec)	Jump height (JH) and contact time (CT) in DJ from 24-cm, and SJ	- Sig. decrease in JH in DJ and SJ - Sig. increase in CT in DJ

Research	Subjects	Treatment	Criteria	Results
Nelson et al. (2001a): "Inhibition of maximal voluntary isokinetic torque production following stretching is velocity-specific"	10 males and 5 females	Static stretching (4 ex. x 4 rep. x 30 sec) 1 active and 3 passive stretching exercises	Maximal isokinetic knee-extension torques (dominant leg) at 5 specific movement velocities (1.05, 1.57, 2.62, 3.67, and 4.71 °/sec)	Maximal torque was sig. reduced: - at 1.05 °/sec (-7.2 %). - at 1.57 °/sec (-4.5 %), In the other velocities (2.62, 3.67, and 4.71 °/s) was unaltered
Nelson et al. (2001b): "Inhibition of maximal voluntary isometric torque production by acute stretching is joint-angle specific"	30 male and 25 female college students	Static stretching (2 ex. x 4 rep. x 30 sec) (10 min passive stretching with 30 sec hold for m. quadriceps femoris in the dominant leg)	MVC (knee extension at 90°, 108°, 126°, 144° and 162°)	Sig. decrease in MVC (-7 %) just in knee angle of 162°
Cornwell et al. (2002): "Acute effects of stretching on the neuromechanical properties of the triceps surae muscle complex"	10 males	Static stretching (3 sets x 2 ex. x 30 sec)	JH in CMJ	Sig. decrease in JH (-1.9%)
Young & Behm (2003): "Effects of running, static stretching and practice jumps on explosive force production and jumping performance"	13 males and 3 females	a) Control b) 4 min run c) Static stretching (4 ex. x 30 sec) d) 4 min run + static stretching e) 4 min run + static stretching + jumps	- JH in SJ - JH and CT in DJ - Peak force - Rate of force developed	- (b) is sig. better than (d) for JH in DJ (3.2%), SJ (3.4%), PF (2.7%) and rate of force developed (15.4%) - (b) and (d) produced the highest PF - (b) is sig. better than (d) in SJ, PF and DJ

Research	Subjects	Treatment	Criteria	Results
Wiemeyer (2003): “Dehnen und Leistung-primär psychophysiologische Entspannungseffekte?”	14 subjects	Static stretching (3 sets x 3 ex. x 20 sec)	JH in jump and reach test	Sig. decrease in JH (-2.6%)
Evetovich et al. (2003): “Effect of static stretching of the biceps brachii on torque, electromyography, and mechanomyography during concentric isokinetic muscle actions”	18 subjects	a) Static stretching b) Control	- Maximal concentric isokinetic (30 and 270 °/sec) forearm flexion strength (biceps brachii)	- Sig. greater torque in control group.
Cramer et al. (2004): “The acute effects of static stretching on peak torque in women”	21 females	Static stretching (1 active and 3 passive ex.) 4 sets x 4 ex. x 30 sec	Concentric, isokinetic leg extension peak torque (PT) at 60 and 240 °/sec	Sig. decrease in PT following the static stretching in both limbs and at both velocities
Power et al. (2004): “An acute bout of static stretching: effects on force and jumping performance”	12 males	Static stretching (quadriceps and plantar flexors)	- MVC (pre, post, after 30, 60, 90, and 120 min)	- Sig. overall 9.5% decrements in the torque or force of the quadriceps for MVC. - Force remained sig. decreased for 120-min (10.4%)
Fletcher et al.(2004): “The effect of different warm-up stretch protocols on 20 meter sprint performance in trained rugby union players”	97 Rugby players	a) Passive static stretching b) Active dynamic stretching c) Active static stretching d) Dynamic stretching + static stretching	20-m sprint	- After (a) and (c) sig. decrease of sprint performance. - After (b) sig. improvement of sprint performance. - After (d) improvement of sprint performance but non-sig.

Research	Subjects	Treatment	Criteria	Results
Nelson et al. (2005): “Acute effects of passive muscle stretching on sprint performance”	16 track and field athletes (11 males and 5 females)	a) No stretch (NS) b) Both leg stretch (BS). c) Stretch the forward leg in the starting position (FS). d) Stretch the rear leg in the starting position (RS). (4 sets x 3 ex. x 30 sec)	20-m sprint	BS, FS and RS protocols induced a sig. increase (~0.04 sec) in the 20-m time
Cramer et al. (2005): “The acute effects of static stretching on peak torque, mean power output, electromyography, and Mechanomyography”	21 subjects	The dominant leg extensors were stretched using 4 static stretching ex. (4 sets x 4 ex. x 30 sec)	Peak torque (PT), the joint angle at PT, mean power output (MP), during maximal voluntary concentric isokinetic leg extensions at 60 and 240 °/sec of the stretched and unstretched limbs.	PT decreased from pre- to post-stretching for the stretched limb at 60 and 240 °/sec) and for the unstretched limb at 60 °/sec.
Marek et al. (2005): “Acute effects of static and proprioceptive neuromuscular facilitation stretching on muscle strength and power output”	10 females and 9 males	a) Static stretching (4 ex. x 30 sec) b) PNF (4 ex. maximal isometric tension of the leg extensors for 5 sec, followed by a 30 sec passive stretch.	- During voluntary maximal concentric isokinetic leg extensions at 60 and 300 °/sec: - Peak torque (PT) - Mean power output (MP)	Sig. reduction in PT and MP after static stretching and PNF at 60 and 300°/sec.

Research	Subjects	Treatment	Criteria	Results
Wallmann et al. (2005): "Surface electromyographic assessment of the effect of static stretching of the gastrocnemius on vertical jump performance"	14 subjects	Static stretching (3 sets x 30 sec stretching for the gastrocnemius)	- JH in CMJ	- Sig. decrease in JH (-5.6%)
Faigenbaum et al. (2005): "Acute effects of different warm-up protocols on fitness performance in children"	60 children	a) 5 min walking + 5 min static stretching. b) 10 min of dynamic ex. (DY) c) 10 min of dynamic ex.+ 3 DJ from 15-cm box (DYJ)	- Vertical jump - Long jump	- Sig. decreases in vertical-jump after static stretching as compared to DY and DYJ. - Long-jump performance was sig. reduced following static stretching as compared to DYJ.
Hillebrecht & Niederer (2006): "Lassen sich Leistungseinbußen bezüglich der Reaktivekraft nach statischem Dehnen aufheben?"	35 sport students	Static stretching (6 ex. x 15 sec)	JH in DJ from 24cm	Sig. decrease in DJ
Behm et al. (2006): "Flexibility is not related to stretch-induced deficits in force or power"	12 subjects	Static stretching (Stretches for the quadriceps, hamstring and plantar flexors was repeated 3 times with holding for 30 sec)	- MVC (knee extension and knee flexion). - JH in CMJ - JH and CT in DJ	-Sig. decrease in knee extension MVC (-6.1% to -8.2%) -Sig. decrease in knee flexion MVC (-6.6% to-10.7%) - Sig increase in CT of DJ (5.4% to 7.4%) and no sig. changes in JH - Sig. decrease in JH of CMJ (-5.5% to -5.7 %)

Research	Subjects	Treatment	Criteria	Results
Young et al. (2006): “Effects of static stretching volume and intensity on plantar flexor explosive force production and range of motion“	20 subjects	a) Control b) 1-min static stretching at 100% intensity (just before the pain threshold). c) 2 min static stretching at 100% intensity d) 4 min static stretching at 100% intensity e) 2 min static stretching at 90% intensity (30 sec holding stretch)	- Peak force and rate of force production in a concentric explosive calf raise. - JH and CT in DJ	- No sig. no differences in peak force or rate of force production in the explosive calf raise between any of the warm-ups. - The 2 min stretch and the 4 min stretch protocols produced sig. lower DJ performance (JH and CT) than the run. - The 4 min stretch warm-up produced a sig. lower DJ score than the 1 min stretch warm-up. - The 2 min stretch at 90% intensity had no sig. influence on muscle function
Brandenburg (2006): “Duration of stretch does not influence the degree of force loss following static stretching”	16 recreationally trained males and females	a) Static stretching (3 sets x 2 ex. x 15 sec) b) Static stretching (3 sets x 2 ex. x 30 sec)	- Hamstring performance during isometric, concentric, and eccentric actions	- Sig. main effect of time (pre- vs. post-stretch, but no interaction effect (time x static stretching protocol) - The duration of stretch did not influence the degree of force loss
Yamaguchi et al. (2006): “Acute Effect of Static Stretching on Power Output During Concentric Dynamic Constant External Resistance Leg Extension”	12 healthy male subjects	a) Static stretching (4 sets x 6 ex. x 30 sec) b) Control	Power output to 5, 30, and 60% of the maximum voluntary contraction (MVC) torque with isometric leg extension	- Sig. lower peak power output following the static stretching than following the control under each load

Research	Subjects	Treatment	Criteria	Results
Cramer et al. (2007a): “Acute effects of static stretching on characteristics of the isokinetic angle - torque relationship, surface electromyography, and Mechanomyography”	18 subjects	Static stretching (4 ex.) for the dominant leg extensors	- Peak torque, work, the joint angle at peak torque, acceleration time and isokinetic range of motion during max. concentric isokinetic leg extensions at 1.04 and 5.23 °/sec	- Sig. decrease in peak torque - Sig. decrease in acceleration time. - No sig. changes in work or joint angle at peak torque.
Vetter (2007): “Effects of six warm-up protocols on sprint and jump performance”	26 active males and females	a) Walk + run (WR) b) WR + exercise series (toe raises, high knees lifting marching, buttocks kick marching and small jumps) c) WR + active dynamic stretching d) WR+ active dynamic stretching + exercise series e) WR + static stretching (4 ex. x 2 rep. x 30 sec) + exercise series f) WR + static stretching	JH in CMJ	- Sig. decrease of JH in all groups - JH in (a) was sig. higher than in (f) - JH in (c) was sig. higher than in (f)
Ogura et al. (2007): “Duration of static stretching influences muscle force production in hamstring muscles”	10 males	a) Control b) Static stretching (30 sec) c) Static stretching (60 sec) (for the hamstring muscles in the dominant leg)	- MVC was measured using the maximal effort of knee flexion	- MVC was sig. lowered with static stretching for 60 sec compared to the control and static stretching for 30 sec - No sig. difference between static stretching for 30 sec and control

Research	Subjects	Treatment	Criteria	Results
Bradley et al. (2007): “The effect of static, ballistic, and proprioceptive neuromuscular facilitation stretching on vertical jump performance”	18 male university students	a) Control b) Static stretching (10 min) c) Ballistic stretching (10 min) d) Neuromuscular Facilitation Stretching PNF (10-min)	- JH in SJ - JH in CMJ (prior and post at 5, 15, 30, 45 and 60 min)	- Sig. decrease of JH after static stretching (-4%) and after PNF (-5.1%) - Jumping performance had fully recovered 15 min after all stretching conditions.
Behm & Kibele (2007): “Effects of differing intensities of static stretching on jump performance “	10 participants	a) Static stretching at 100% of Point Of Discomfort. b) Static stretching at 75% of POD. c) Static stretching at 50% of POD. (All stretches for 3 x 30 sec). d) Control.	- JH in CMJ (with preferred jump strategy) - CMJ (to a knee flexion of 70°) - CMJ (with short amplitude) - JH in DJ - JH in SJ	Sig. decreases in JH of 4.6%, 5.7%, 5.4%, 3.8% and 3.6% for the DJ, SJ, CMJ to a knee flexion of 70°, CMJ using a preferred jump strategy and short amplitude CMJ respectively
Fletcher & Anness (2007): “The acute effects of combined static and dynamic stretch protocols on fifty-meter sprint performance in track-and-field athletes”	18 experienced sprinters	a) Active dynamic stretch (ADS) b) Static passive stretch combined with ADS (SADS) c) Static dynamic stretch combined with ADS (DADS)	50-m sprint	- After SADS sig. slower 50 -m sprint times than either after ADS or DADS.
Hillebrecht et al. (2007): “Reduzieren sich Sprintleistungen nach statischem Dehnen?”	8 track athletes	Static stretching (6 ex. x 15-sec)	50-m sprint	- Sig. decrease in sprint performance

Research	Subjects	Treatment	Criteria	Results
Holt & Lambourne (2008): “The impact of different warm-up protocols on vertical jump performance in male collegiate athletes”	46 male colle- giate football players	a) warm-up only b) warm-up + static stretching c) warm-up + dynamic stretch- ing d) warm-up + dynamic flexibil- ity	JH in CMJ	Jump performance improved in all groups; however, the mean for the static stretching group was sig. lower
Winchester et al. (2008): “Static stretching impairs sprint performance in collegiate track and field athletes”	22 athletes of a track team	a) Dynamic warm-up (DW) + static stretching b) DW + rest	40-m sprint (timing at 0, 20, and 40-m)	- Sprint performance in the DW + rest group versus the DW + static stretching group was sig. faster for the second 20 m and for the entire 40-m
Sayers et al. (2008): “The effect of static stretching on phases of sprint performance in elite soccer players”	20 elite female soccer players	a) Static stretching b) Control	30-m sprints (acceleration, maxi- mal-velocity sprint time and overall sprint time)	- Sig. decrease in acceleration, maxi- mal-velocity sprint time and overall sprint time between the stretch and no- stretch conditions
Siatras et al (2008): “The duration of the in- hibitory effects with static stretching on quadriceps peak torque production”	50 subjects	a) No stretch b) 10 sec static stretching c) 20 sec static stretching d) 30 sec static stretching e) 40 sec static stretching	- Isometric and con- centric isokinetic peak torques of the quadriceps at 60 °/sec and 180 °/sec.	- Sig. isometric and isokinetic peak torque reductions only after 30 and 60 sec of quadriceps static stretching. (Isometric -8.5% and -16.0%) (Isokinetic -5.5% vs. 11.6% at 60°/sec -5.8% vs. 10.0% at 180°/sec

Research	Subjects	Treatment	Criteria	Results
Ryan et al. (2008): “Do practical durations of stretching alter muscle strength? A dose-response study”	13 subjects	a) 2-min static stretching b) 4-min static stretching c) 8-min static stretching d) Control	- Isometric peak torque (PT) - Percent voluntary activation (%VA) - Peak twitch torque (PTT) - Rate of twitch torque development (RTD) (all for plantarflexors)	- Sig. decrease in PT immediately after all conditions [CON (4%), static stretching2 (2%), static stretching4 (4%), and static stretching8 (6%)] but returned to baseline at 10, 20, and 30 min post stretching - Sig. decrease in PTT and RTD immediately after the static stretching4 (7%) and the static stretching8 (6%) however, these changes were not sufficient to alter voluntary force production
Herda et al. (2008): “Acute effects of static versus dynamic stretching on isometric peak torque, electromyography, and mechanomyography of the biceps femoris muscle”	14 males	a) Static stretching (4 sets x3 ex. x 30 sec for the right hamstrings) b) Dynamic stretching (4 sets x 3 ex., 12-15 rep. with each set lasting 30 sec for the right hamstrings)	- Peak torque (PT) during isometric maximal voluntary contractions of the leg flexors at knee joint angles of 41, 61, 81 and 101 degrees below full leg extension.	- Sig decrease in PT after static stretching at 81, 101 degrees but not at other angles - No sig. changes in PT after DS - No sig. in EMG amplitude after static stretching but increased after DS at 101 and 81 degrees
Winchester et al. (2009): “A single 30-s stretch is sufficient to inhibit maximal voluntary strength”	18 college students	1-6 rep. of static stretching for 30 sec of hamstring stretching)	1-RM test of knee-flexion following 0, 1, 2, 3, 4, 5, or 6 stretching bouts.	Stretching significantly reduced 1RM after one 30-s stretch (5.4%), and continued to decrease 1-RM up to and including 6 x 30 sec stretches (12.4%)
Sekir et al. (2010): “Acute effects of static and dynamic stretching on leg flexor and extensor isokinetic strength in elite women athletes”	10 elite women athletes	a) Control b) Static stretching c) Dynamic stretching	- Concentric and eccentric isokinetic Peak Torque of the leg extensors and flexors at 60 and 180 °/sec.	- A sig. decrease after static stretching and a sig. increase after dynamic stretching in concentric and eccentric quadriceps and hamstring muscle strength at both test speeds displayed

Research	Subjects	Treatment	Criteria	Results
Bacurau et al. (2009): "Acute effect of a ballistic and a static stretching exercise bout on flexibility and maximal strength"	14 physical-ly active females	a) Control b) Static stretching c) Ballistic stretching	- Maximal strength at 45 degrees leg press (1RM)	- Sig. decreased in maximal strength after static stretching - No sig. changes after ballistic stretching
Costa et al. (2009): "Effects of stretching on peak torque and the H:Q ratio"	13 women	4 rep. of 1 unassisted and 3 assisted static stretching exercises (30 sec) for the posterior muscles of the thigh and leg.	- Leg flexion concentric isokinetic peak torque at 60, 180 and 300°/sec	- Sig decrease in performance
Taylor et al. (2009): "Negative effect of static stretching restored when combined with a sport specific warm-up component"	13 netball players	a) Static stretching (15 min) b) Dynamic stretching	- Vertical jump performance - 20-m sprint	- Sig. decrease in JH (-4.2%) after static stretching when compared to after dynamic stretching - Sig. increase in sprint time (+1.4%) after static stretching when compared to after dynamic stretching
Hough et al. (2009): "Effects of dynamic and static stretching on vertical jump performance and electromyographic activity"	11 healthy men	a) Static stretching (1 set x 30 sec) b) Dynamic stretching c) Control.	- JH in SJ	- JH was sig. less (4.19 +/- 4.47%) after static stretching than control. - JH was sig. greater (9.44 +/- 4.25%) in DS than static stretching
Beckett et al. (2009): "Effects of static stretching on repeated sprint and change of direction performance"	12 male team-sport players	(a) Static stretching (b) Control	- Repeated sprint ability RSA (6 times) - Change of direction speed (CODS) performance.	- Consistent tendency for RSA times to be slower after the static stretching. -Sprint times tended to be slower in the CODS-SS trial compared with the CODS-CON across all sprint variables, with a sig. slower BST recorded for set 3 after static stretching

Research	Subjects	Treatment	Criteria	Results
Chaouachi et al. (2010): “Effect of warm-ups involving static or dynamic stretching on agility, sprinting, and jumping performance in trained individuals”	elite athletes	a) Static stretching to point of discomfort (POD). b) Static stretching less than POD (SS <POD). c) Dynamic stretching (DS). d) SS POD + DS. e) SS <POD + DS. f) DS + SS POD. j) DS + SS<POD. h) Control	- 30-m sprint, - Agility run	- The control condition showed significant differences for faster times than the dynamic stretching + SS <POD condition in the 30-m (1.9%) sprint. - No other sig. differences in all other conditions and tests.
La Torre et al. (2010): “Acute effects of static stretching on squat jump performance at different knee starting angles”	17 subjects	a) Static stretching (10 min) b) Control	SJ at different knee starting angles: 50, 70, 90, and 110 degrees: (JH, peak force, maximal acceleration, velocity, and power)	- Sig. lower performance in the stretching condition. - Decrements were sig. higher at lower knee starting angles. - Peak power was obtained at 90° in both control and stretching conditions, but was sig. lower after stretching.
Kistler et al. (2010): “The acute effects of static stretching on the sprint performance of collegiate men in the 60- and 100-m dash after a dynamic warm-up”	18 sprinters, hurdlers and jumpers	Initial warm up (800-m run, dynamic movements, sprint and hurdle drills) a) Static stretching (4 stretches for the calf, hamstring and thigh with holding for 30 sec) b) Control	100-m sprint with electronic timing for 0, 20, 40, 60 and 100-m distances.	- Sig. lower sprint performance just for the distance between 20- and 40-m - No sig. differences in other distances

Research	Subjects	Treatment	Criteria	Results
Faigenbaum et al. (2010): “Influence of recovery time on warm-up effects in male adolescent athletes”	19 males	a) Static stretching b) Dynamic stretching	- Vertical jump (VJ) (baseline and after 2, 6, 10, 14, 18, 22 min)	- Sig. decrease in VJ from baseline at 2, 6, 10, 14 and 18 min following static stretching (-3.2% to -7.0%)
Evetovich et al. (2010): “Interpreting normalized and nonnormalized data after acute static stretching in athletes and non-athletes”	15 athletes and 14 non-athletes	Static stretching (4 rep. x 4 ex. with holding for 30 sec at a point of mild discomfort)	- Isokinetic leg extensions at 60 and 300 °/sec	1. When comparing all subjects: - Sig. decrease in torque 2. When comparing athletes and non-athletes: - Sig. decrease in torque in nonathletes, whereas no changes in athletes
Babault et al.(2010): “Acute effects of 15min static or contract-relax stretching modalities on plantar flexors neuromuscular properties”	10 subjects	a) Static stretching: 20 stretches with holding for 30 sec. b) Sub-maximal contract-relax stretching: 20 stretches, 6 sec sub-maximal isometric plantar flexion before 24 sec static stretches.	- Max. voluntary isometric torque (MVT) in plantar flexion.	- MVT sig. decreases, but no difference was between (a) and (b)

Table 4: A review of researches in which **NO** acute effect of static stretching on force, torque and jump performance was found.

Research	Subjects	Treatment	Criteria	Results
Rosenbaum & Hennig (1997): "Veränderung der Reaktionszeit und Explosivkraftentfaltung nach einem passiven Stretching"	55 subjects	Static stretching: (2 ex. x 3 rep. x 20 sec)	MVC (plantar flexion)	- No sig. change after stretching
Church et al. (2001): "Effect of warm-up and flexibility treatments on vertical jump performance"	40 trained females	a) Static stretching (10 rep. x10 sec) b) PNF stretching (10 rep. x10 sec) c) Control	JH in CMJ	- No sig. change after static stretching - Sig. decrease after PNF
Cornwell et al. (2002): "Acute effects of stretching on the neuromechanical properties of the triceps surae muscle complex"	10 males	Static stretching (3 sets x 2 ex. x 30 sec)	JH in SJ	- No sig. changes in JH
Power et al. (2004): "An acute bout of static stretching: effects on force and jumping performance"	12 males	Static stretching	- JH in SJ - JH and CT in DJ (pre, post, after 30, 60, 90, and 120 min)	- No sig. changes in all parameters

Research	Subjects	Treatment	Criteria	Results
Unick et al. (2005): “The acute effects of static and ballistic stretching on vertical jump performance in trained women”	16 actively trained females	a) Ballistic stretching b) Static stretching c) Control	- JH in CMJ - JH in DJ (pre, post, after 15 and after 30 min)	- No sig. changes after SS - No sig. differences between (a), (b) and (c)
Burkett et al. (2005): “The best warm-up for the vertical jump in college-age athletic men”	29 football players in speed positions	a) 5 sub-maximum jumps by 75% of CMJ b) 5 jumps with hand barbell 10% of body weight into a box c) Static stretching (14 ex. x 20 sec). d) Control	- JH by CMJ	- No sig. changes following static stretching. - Sig. difference between (b) and the other conditions
Yamaguchi et al. (2005): “Effects of static stretching for 30 seconds and dynamic stretching on leg extension power”	11 healthy male students	a) Static stretching b) Dynamic stretching c) Control	- Leg extension power	- No sig. changes after static stretching - Sig. increase after dynamic stretching

Research	Subjects	Treatment	Criteria	Results
Egan et al. (2006): “Acute effects of static stretching on peak torque and mean power output in National Collegiate Athletic Association Division I women's basketball players”	11 female basketball players	One unassisted and three assisted static stretching ex. for the dominant leg extensors	Maximal concentric isokinetic leg extensions at 60 and 300 °/sec (The poststretching isokinetic assessments were repeated at 5, 15, 30, and 45 minutes after the static stretching post-5, post-15, post-30, and post-45)	- No sig. changes in PT or MP from pre- to poststretching for any of the testing intervals
O'Connor et al. (2006) “Effects of static stretching on leg power during cycling”	27 subjects	a) Static stretching (15-min) b) Control	4 x10-sec leg power tests during cycling at 5, 20, 40 and 60-min postwarm-up	- Sig. greater peak power and total work after static stretching compared to the control on all power tests - Peak power was achieved more quickly for static stretching compared to the control on the 5 min test only
Cramer et al. (2006): “Acute effects of static stretching on maximal eccentric torque production in women”	13 females	The dominant leg extensors were stretched 21 min) using 1 unassisted and 3 assisted static stretching exercises	Maximal voluntary, eccentric isokinetic muscle actions of the leg extensors with the dominant and nondominant limbs at 60 and 180°/sec Peak torque (PT) and the joint angle at PT	- No sig. changes from pre- to poststretching for PT or the joint angle at PT

Research	Subjects	Treatment	Criteria	Results
Faigenbaum et al. (2006): "Dynamic warm-up protocols, with and without a weighted vest, and fitness performance in high school female athletes"	30 athletes	a) Static stretching (2 sets x 5 ex. x 30 sec) b) 9 dynamic ex. (moderate-intensity to high-intensity dynamic exercises (DY) c) The same 9 dynamic exercises with a vest weighted with 2% of body mass (DY2), d) The same 9 dynamic exercises performed with a vest weighted with 6% of body mass (DY6)	- Vertical jump - Long jump - Seated medicine ball toss - 10 yards Sprint	- No sig. differences between trials for the seated medicine ball toss - No sig. differences between trials for the 10 yard sprint - Vertical jump performance was sig. greater after DY (41.3 +/- 5.4 cm) and DY2 (42.1 +/- 5.2 cm) compared with static stretching (37.1 +/- 5.1 cm) - Long jump performance was sig. greater after DY2 (180.5 +/- 20.3 cm) compared with static stretching (160.4 +/- 20.8 cm)
Young et al. (2006): "Effects of static stretching volume and intensity on plantar flexor explosive force production and range of motion"	20 subjects	a) Control b) Static stretching 1 min c) Static stretching 2 min d) Static stretching 4 min e) Static stretching 2 min at 90% intensity	Peak force (PF) and rate of force production (RFP) in an explosive concentric calf raise	- No sig. differences in PF or RFP between any of the warm-ups
McMillian et al. (2006) "Dynamic vs. static-stretching warm up: the effect on power and agility performance"	30 cadets at the Military Academy	a) Static stretching b) Dynamic warm-up c) Control	- T-shuttle run - Underhand medicine ball throw for distance - 5-step jump	- No sig. difference between (a) and (c) in T-shuttle run and medicine ball throw - Sig. better 5 step-jump performance after static stretching - Sig. better performance in (b) in all tests

Research	Subjects	Treatment	Criteria	Results
Little & Williams (2006): "Effects of differential stretching protocols during warm-ups on high-speed motor capacities in professional soccer players"	18 professional soccer players	a) Static stretching b) Dynamic stretching c) Control	- JH in CMJ - Stationary 10 m sprint - Flying 20 m sprint - Agility performance	- No sig changes in CMJ - Dynamic stretching produced sig. faster 10-m sprint times than did the control protocol - Dynamic stretching and static stretching produced faster flying 20-m sprint times than did the control protocol - Dynamic stretching produced sig. faster agility performance than did the static stretching or control
Vetter (2007): "Effects of six warm-up protocols on sprint and jump performance"	26 active males and females	a) Walk + run (WR) b) WR + exercise series (toe raises, high knees lifting marching, buttocks kick marching and small jumps) c) WR + active dynamic stretching d) WR+ active dynamic stretching + exercise series e) WR + static stretching (4 ex. with 30 sec holding) + exercise series f) WR + static stretching	30-m sprint	- No sig. difference between the groups
Brandenburg et al. (2007): "Time course of changes in vertical-jumping ability after static stretching"	16 experienced jumpers	a) Static stretching (3 sets x3 ex. x 30 sec) b) Control	JH in CMJ (pre-treatment and immediately, 3, 6, 12, and 24 min post treatment)	- There were a reduction in JH in both groups, and remained impaired for the 24-min - In comparison with the control, static stretching resulted in similar reductions in JH when examined over the same time course

Research	Subjects	Treatment	Criteria	Results
Alpkaya & Koceja (2007): "The effects of acute static stretching on reaction time and force"	15 subjects	a) Static stretching (3 sets x 15 sec) b) Control	- Reaction time - Force production	- No sig. differences between groups
Cramer et al.(2007b): "An acute bout of static stretching does not affect maximal eccentric isokinetic peak torque, the joint angle at peak torque, mean power, electromyography, or mechanomyography"	15 males	Static stretching for the dominant lower extremity knee extensors	- Peak torque, the joint angle at peak torque and mean power output during maximal eccentric isokinetic muscle actions of the dominant and non-dominant knee extensor muscles at 60 and 180 °/sec	- No sig. changes in peak torque, joint angle at peak torque or mean power output
Samuel et al. (2008): "Acute effects of static and ballistic stretching on measures of strength and power"	24 subjects	a) Static stretching (3 rep. x 30 sec) b) Ballistic stretching c) Control	- Vertical jump height - Lower-extremity power - Quadriceps and hamstring torque	- No sig. changes after SS or BS - The gender x stretch interaction was not sig. for any of the measures (stretching conditions did not affect men and women differently)
Cronin et al. (2008): "The acute effects of hamstring stretching and vibration on dynamic knee joint range of motion and jump performance"	10 males	a) A single bout of passive hamstring static stretching (3 sets x 30 sec) b) Hamstring vibration c) Combination of both	- Vertical jump performance (prior, immediately following and 10 after min)	- No sig. changes in JH following the static stretching. - No sig. difference in JH between groups

Research	Subjects	Treatment	Criteria	Results
Wallmann et al. (2008): "Surface electromyographic assessment of the effect of dynamic activity and dynamic activity with static stretching of the gastrocnemius on vertical jump performance"	13 healthy adults (7 males and 6 females)	a) Dynamic activity only. b) Dynamic activity + static stretching	- JH in CMJ	- No sig. difference in JH
Cè et al. (2008): "Effects of stretching on maximal anaerobic power: the roles of active and passive warm-ups"	15 fit males	a) Passive static stretching b) Active warm-up (AWU) c) Passive warm up (PWU) d) AWU+ static stretching e) PWU+ static stretching f) Control	JH, Flight time (FT), peak force (PF), and max. power (Wpmax) were calculated in CMJ and SJ	- Static stretching did not negatively affect the maximal anaerobic power, but seems to inhibit the effect of AWU. - FT, PF, and Wpmax values were sig. higher after AWU than after PWU and PWU+S in CMJ; and in AWU as compared to those of other protocols of SJ
Robbins & Scheuermann (2008): "Varying amounts of acute static stretching and its effect on vertical jump performance"	20 athletes	a) 2 sets of static stretching (hold for 15 sec) b) 4 sets of static stretching c) 6 sets of static stretching d) Control	Vertical jump performance	- Post-6 sets were sig. lower than Pre-6 sets - Post-6 sets were sig. lower than Pre-4 sets, Pre-2 sets, and Pre-control - No other sig. differences

Research	Subjects	Treatment	Criteria	Results
Manoel et al. (2008): “Acute effects of static, dynamic, and proprioceptive neuromuscular facilitation stretching on muscle power in women”	12 recreationally active females	a) Static stretching b) Dynamic stretching c) PNF d) Control	- Concentric knee extension power isokinetically at 60 and 180 °/sec	- No sig. decrease in knee extension power in all conditions. - Dynamic stretching produced sig. increases (8.9%) at 60 and (6.3%) at 180 °/sec and that was sig. greater than changes in power after static stretching and PNF
Torres et al. (2008): “Effects of stretching on upper-body muscular performance”	11 track and field athletes	a) Static stretching (2 rep. x 15 sec) b) Dynamic stretching c) Static stretching + dynamic stretching d) Control	- Bench throw by 30 % of 1-RM - Isometric bench press - Overhead medicine ball throw - Lateral medicine ball throw. (Depending on the exercise, test peak power (Pmax), peak force (Fmax), peak acceleration (Amax), peak velocity (Vmax), and peak displacement (Dmax)	- No sig. differences among stretch trials for Pmax, Fmax, Amax, Vmax, or Dmax for the bench throw or for Fmax for the isometric bench press - No sig. differences among stretch trials for the overhead medicine ball throw for Vmax or Dmax - No sig. differences among stretch trials for the lateral medicine ball throw in Vmax - Dmax was sig. larger for the static and dynamic condition compared to the static-only condition
Costa et al. (2009): “Effects of stretching on peak torque and the H:Q ratio”	13 women	4 rep. of 1 unassisted and 3 assisted static stretching exercises (30 sec) for the posterior muscles of the thigh and leg.	- Leg extension peak torque and the hamstrings-to-quadriceps ratio during maximal, concentric isokinetic muscle actions at 60, 180 and 300°/sec	No significant changes

Research	Subjects	Treatment	Criteria	Results
Curry et al.(2009): “Acute effects of dynamic stretching, static stretching, and light aerobic activity on muscular performance in women”	24 healthy un- trained females	a) Static stretching b) Dynamic stretching c) Light aerobic activity	- JH in CMJ - Isometric time to peak force during knee extension (posttest at 5 and 30-min following the intervention)	- No sig. changes following static stretching - No sig. differences between the groups
González-Rave et al. (2009): “Acute effects of heavy-load exercises, stretching exercises, and heavy-load plus stretching exercises on squat jump and counter-movement jump performance”	24 un- trained males	a) Strength ex. using heavy loads (3 sets of 4 rep. at 90% of 1-RM) b) Heavy-load ex. + 3 static stretching exercises c) Static stretching (3 ex. x 15 sec)	- JH in SJ - JH in CMJ	- Static stretching exercises showed an increase in SJs and CMJs, but these results were not significantly different from all other scores - No sig. differences between the groups
Sim et al. (2009): “Effects of static stretching in warm-up on repeated sprint performance”	13 male team sport players	(a) Dynamic activities only (D) (b) Static stretching (SS) followed by dynamic activities (SS+D) (c) Dynamic activities followed by static stretching (D+SS)	- Sprint ability test consisting of three sets of maximal 6x 20-m sprints (going every 25 sec)	- Sprint performance was slowest in (D+SS) than (SS+D) and (D) - No sig. differences between the (SS+D) and (D)
Favero et al. (2009): “Effects of an acute bout of static stretching on 40 m sprint performance: influence of baseline flexibility”	10 trained males	(a) Static stretching (b) Control	40-m sprint	- No sig. difference

Research	Subjects	Treatment	Criteria	Results
Chaouachi et al. (2010): "Effect of warm-ups involving static or dynamic stretching on agility, sprinting, and jumping performance in trained individuals"	elite athletes	a) Static stretching (SS) to point of discomfort (POD). b) (SS) less than POD c) Dynamic stretching (DS) d) (SS) POD combined with (DS) e) (SS)<POD combined with (DS) f) (DS) combined with (SS)POD g) (DS) combined with (SS)<POD h) Control	JH in CMJ	- No sig. changes following static stretching - No sig. differences between
Dalrymple et al. (2010): "Effect of static and dynamic stretching on vertical jump performance in collegiate women volleyball players"	12 female collegiate volleyball players	a) Static stretching (8 min) b) Dynamic stretching (8 min) c) Control	JH in CMJ	- No sig. differences between the static stretching, dynamic stretching, and control - There were notable individual responses to each of the warm-up conditions
Handrakis et al (2010) "Static stretching does not impair performance in active middle-aged adults"	10 subjects (40-60 years)	a) Static stretching (10 min, holding for 30 sec hold) b) Control	- JD in SBJ - JD in single hop - JD in triple hop - JD in crossover hop - Elapsed time for a 6-m timed hop	- No sig. difference in all tests
Winke (2010): "Moderate static stretching and torque production of the knee flexor"	13 females and 16 males	a) Static stretching (3 min for the knee flexor) b) Control	Isokinetic concentric and eccentric peak torque at 60 and 210°/sec	- No sig. differences in peak torque between the stretching and control conditions for either velocity or contraction type

Research	Subjects	Treatment	Criteria	Results
Molacek et al. (2010): "Effects of low- and high-volume stretching on bench press performance in collegiate football players"	15 male National Colligate football players	A 1-RM dynamic warm-up routine integrated with 5 different protocols: a) Control b) PNF (2 sets x 2 ex.) c) PNF (5 sets x 2 ex.) d) Static stretching (2 sets x 2 ex.) e) Static stretching (5 sets x 2 ex.) (30 sec holding the stretch)	1-RM bench press	- No sig. differences
Di Cagno et al.(2010): "Preexercise static stretching effect on leaping performance in elite rhythmic gymnasts"	38 gymnasts	a) Static stretching b) Usual typical warm-up (TWU) as control	Flight time (FT) and ground contact time (CT) in: SJ, CMJ and Hopping test (HT)	- No sig. changes in FT - CT sig. increased after stretching
Faigenbaum et al. (2010):"Influence of recovery time on warm-up effects"	19 males	a) Static stretching b) Dynamic stretching	- Seated medicine ball toss (baseline and after 2, 6, 10, 14, 18, 22 min)	- No sig. changes in medicine ball toss
Murphy et al. (2010): "Aerobic activity before and following short-duration static stretching improves range of motion and performance vs. a traditional warm-up"	10 males	a) Static stretching (6 rep. x 6 sec stretches) b) 10 min of running followed by static stretching c) 5 min of running followed by static stretching, then followed again by 5 min running d) 10 min running (control)	- JH in CMJ - Reaction time (RT) - Movement time (MT) (baseline and at 1 and 10 min post-warm-up)	- No main effect for condition but there was a main effect for time, with CMJ height (sig. 4.1 % and 1.6 % at 1 and 10 min post-warm-up)

2.3.5.5 Analysis of the reviewed studies in table 3 and 4

In the previously reviewed investigations in table 3 and 4, 49 studies registered significant decreases in force, torque, jump or sprint performances after an acute bout of static stretching. On the other hand, many other studies (39 studies) observed equivocal performances. Even more, sometimes in one investigation there was a decrease in one measure and not in the other, for example in the study of Cornwell, Nelson and Sidaway (2002) there was a significant decrease in jump height in countermovement jump but no change in squat jump, as well as in the study of Behm, Bradbury, Haynes, Hodder, Leonard and Paddock (2006) a significant decrease in jump height in countermovement jump and an increase in contact time in drop jump from a height of 30-cm were registered, whereas the jump height in drop jump was not significantly affected.

Just few studies reported an enhancement in performance following static stretching. In the study of O'Connor, Crowe and Spinks (2006), 15 minutes of lower body static stretching (2 sets x 11 stretches with holding for ten seconds) significantly improved the following 10-sec leg power performance during cycling (peak power, time to peak power and total work leg power tests at 5, 20, 40 and 60 minutes postwarm-up) as compared to the control condition. In the study of McMillian, Moore, Hatler & Taylor (2006) an increase in 5-step-jump performance following ten minutes static stretching was registered as compared to the control condition, whereas no changes were found in medicine ball throw or T-shuttle run. A bout of static stretching in the study of Little and Williams (2006) also produced faster flying 20-m sprint times than did the control protocol.

2.3.5.5.1 Effect of the way of testing performance

In the reviewed studies in table 3, in which performance-deficits following static stretching are shown, performances were measured in eleven studies in jump height in countermovement jump, six studies were in jump height in squat jump (SJ), five studies were in jump height and contact time in drop jump, one study was in jump distance (JD), eleven studies were in muscle voluntary contraction, six studies were in isokinetic force, one study was in one-repetition maximum test and ten studies were in sprint performance. In studies in which no changes in performance following static stretching were registered (table 4), performances were measured in jump height in countermovement jump (15 studies), in jump height in squat jump (three studies), in jump height and contact time in drop jump (two studies), in various horizontal jump tests (three studies), in isometric muscle voluntary contractions (four studies), in isokinetic force (ten studies), sprint performances (five studies), medicine ball throw (two studies), handball throwing speed (one study), 1-RM bench press (one study), and in leg power tests (two studies).

Some studies aimed to investigate if some performances responses to an acute bout of static stretching more than others, or even if the same performance in other joint angles or other movement velocities show more or less responses. Kovacs (2006) reported that the effect of static stretching on performance might depend on the speed of movement required by the activity.

Nelson, Guillory, Cornwell and Kokkonen (2001a) investigated the effect of an acute stretching regimen on maximal isokinetic knee-extension torque for the dominant leg at five specific movement velocities (1.05, 1.57, 2.62, 3.67, and 4.71 °/seconds). Following the baseline torque measurements, the participants stretched the dominant quadriceps for 15 minutes using one active and three passive stretching exercises. The maximal torque measurements were repeated directly after completing the stretching exercises. Poststretch maximal torques at 1.05 and 1.57 °/seconds were significantly reduced (-7.2 %, -4.5 %) respectively, but at the other velocities (2.62, 3.67, and 4.71 °/seconds) maximal torque was unaltered. They concluded that the deleterious effect of stretching exercises on maximal torque production might be limited to movements performed at relatively slow velocities.

In another study, Nelson, Allen, Cornwell and Kokkonen (2001b) investigated the effect of two static stretching exercises of the quadriceps muscle group on maximal voluntary isometric torque (knee extension) in various knee joint angles (90°, 108°, 126°, 144° and 162°). MVC performance was significantly decreased merely in knee joint angle of 162°. They reported that the force decrement following static stretching would be more apparent at joint angles that were close to full extension.

La Torre, Castagna, Gervasoni, Cè, Rampichini, Ferrarin & Merati (2010) examined the effects of static stretching (ten minutes of quadriceps and triceps surae muscles) or a control condition on squat jump at different knee starting angles (50, 70, 90 and 110 degrees). The results showed that the jump height, peak force, and maximal velocity increased according to angle amplitude in both control and stretching conditions, but performance was significantly lower in the stretching condition.

Conclusion: Various performances were in many studies negatively affected following static stretching, including performances in which maximal forces or high rates of force development are needed, fast and slow stretch shortening cycle performances, maximum isometric, isokinetic and isotonic force performances and sprint performances.

2.3.5.5.2 Effect of volume and duration of holding the stretch

In the majority of cases, the duration of holding the stretch in the reviewed studies ranged between 15 and 30 seconds. Which effect this duration has on the degree in loss of the following performance is still conflicted.

Brandenburg (2006) investigated the effect of two static stretching protocols on maximal effort hamstring performance (isometric, concentric and eccentric isokinetic force). During one of the protocols participants were required to hold each stretch for 15 seconds while stretch duration in the second protocol was 30 seconds. Both protocols consisted of three repetitions of two stretching exercises. The results revealed a significant main decrease in hamstring performance in both protocols, but no interaction effect. This means that the two stretch durations had the same effect on performance. He concluded that the duration of holding the stretch did not influence the degree of force loss.

Ogura, Miyahara, Naito, Katamoto and Aoki (2007) reported that the short duration (30 seconds) of static stretching did not have a negative effect on the muscle force production, whereas the performance of MVC of knee flexion following stretching with holding duration of 60 seconds was significantly lowered compared to the control and 30 seconds of the stretching conditions.

In the study of Siatras, Mittas, Mameletzi and Vamvakoudis (2008) significant isometric and isokinetic peak torque reductions have been shown to occur only after a single bout of 30 and 60 seconds of quadriceps static stretching and not after 10 or 20 seconds. Performance decrements were: -8.5 % and -16.0 % for isometric measurements and -5.5 % vs. -11.6 % at 60 °/seconds and by -5.8 % vs. -10.0 % at 180 °/sec for isokinetic measurements, respectively for 30 and 60 seconds stretching durations.

Robbins and Scheuermann (2008) investigated the effect of various amounts of static stretching on vertical jumping performance. Stretching treatments consisted of 2, 4, or 6 sets of stretches, with each stretch held for 15 seconds. Results revealed that post-6 sets were significantly lower than pre-6 sets, and post-6 sets were significantly lower than pre-4 sets, pre-2 sets, and pre-control. No other conditions were significantly different. They concluded that six sets of stretches (or 90 seconds) per muscle group would be detrimental for the following vertical jumping performances.

Winchester, Nelson and Kokkonen (2009) reported that a single 30 seconds stretch is sufficient to inhibit maximal voluntary strength (1-RM of knee flexion) by 5.4 %, and continued to decrease up to six sets of 30 seconds stretches.

Short duration and volume of static stretching (6 sets of 6 seconds holding the stretch) in the study of Murphy, Di Santo, Alkanani and Behm (2010) had no negatively impact on the following countermovement jump, reaction time and movement time.

In the study of Molacek, Conley, Evetovich and Hinnerichs (2010), static stretching with two sets (low volume protocol) as well as five sets (high volume protocol) or nonstretching (control) protocol were completed to investigate the effect of static stretching volumes on the following 1-RM for the bench press. Each stretch was hold for 30 seconds. There were no significant difference between protocols.

Ryan, Beck, Herda, Hull, Hartman, Stout and Cramer (2008) examined the time course for the acute effects of two, four, eight minutes of passive stretching (with 30 seconds

holding the stretch) or control on isometric peak torque in the plantar flexion and EMG amplitude of the muscles *m. gastrocnemius medialis* und *m. soleus*. The peak torque decreased immediately after all conditions (inclusive the control group), but returned at 10, 20, 30 minutes poststretching, whereas the EMG amplitude was unaltered.

Conclusion: There is a tendency that the longer the stretch is held, the more probable is the induction of performance-deficits. Reductions in performance were registered following stretches with a single bout of 30 seconds static stretching, whereas short durations for 10 or 20 seconds of static stretching did not impair performance.

2.3.5.5.3 Effect of the intensity of stretching

The problematic of determination the intensity of a stretch is that subjective feeling of the subjects were used to determine the stretch intensity. Many types of stretch intensities were reported in the literature such as stretching to the point of discomfort or stretching to the pain threshold. In some studies the intensity of stretching was not defined at all.

Young, Elias and Power (2006) investigated the effects of various protocols of one-, two- or three-minutes of static stretching of dorsiflexion just before the pain threshold which was set as 100 % intensity, or two-minutes at 90 % intensity of the plantar flexors in order to determine the effects of volume and intensity of static stretching on explosive force production in a concentric calf raise and jump performance in drop jump. Two minutes of stretching at 90 % intensity had no significant influence on the following performance. The results also revealed no significant differences in peak force or rate of force production in the explosive calf raise between any of the protocols. Merely the four-minutes stretching produced a significantly lower drop jump score than the one-minute stretching.

Chaouachi, Castagna, Chtara, Brughelli, Turki, Galy, Chamari and Behm (2010) investigated if there are any differences between the effects of two intensities of static stretching on the performance of 30-m sprint, agility run, and jump tests. The intensities of stretching were either to the point of discomfort or less than the point of discomfort. However, there were no significant changes in performance at both intensities.

On the other hand, all the investigated intensities of static stretching caused impairments in subsequent jumping performance in the study of Behm and Kibele (2007). They aimed to examine the effects of maximal and submaximal intensities (at 100 %, 75 % and 50 % of point of discomfort) of static stretching (four sets with holding for 30 seconds) on the jumping performance in drop jump, squat jump, countermovement jump to a knee flexion of 70 degrees, CMJ using a preferred jump strategy and short amplitude CMJ. There were significant decreases in jump height of 4.6 %, 5.7 %, 5.4 %, 3.8 % and 3.6 %, respectively.

Conclusion: Either stretches with low intensity (50 % of point of discomfort) or high intensity-stretches (100 % of point of discomfort) induced performance decrement.

General conclusion: Jumping, sprinting, power and force performances were sometimes negatively affected and sometimes remained unchanged after a bout of static stretching. The effects of the duration of holding the stretch, the stretching volume or the intensity of stretch as well as the way of testing the performance seem to be overall not significant. One of the critic points in comparing or summarizing the results of the various investigations is the variety of the used exercises, durations, volumes and intensities of the stretch exercises as well as the way of testing the performance. Therefore, the general conclusion of various studies must be carefully interpreted. Static stretching of upper extremities resulted in no effect on subsequent performances in the most of investigations in which performances of upper extremities were tested (Knudson, Noffal, Bahamonde, Bauer & Blackwell, 2004; Torres et al., 2008; Strauß & Wydra, 2010).

2.3.5.6 Effects of static stretching on muscle activity

The results of studies investigated the acute effects of static stretching on the muscle activity (EMG) are conflicting. For example, in the study from Cornwell, Nelson and Sidaway (2002) there was a significant decrease in jump height in countermovement jump but no significant changes in IEMG of triceps surae, while no significant changes in jump height in squat jump but significant decrease in IEMG. Furthermore, in the study of Wallmann, Mercer and McWhorter (2005) the significant decrease in jump height in CMJ by -5.6 % was associated with a significant increase in EMG of m. gastrocnemius by 17.9 %. In other studies there were mostly no changes in the muscle activity also when changes in performance occurred.

Fowles, Sale and MacDougall (2000) found that the muscle activation of soleus was reduced post-stretch and remained reduced up to five minute after 13 maximally passive stretches for 30 minutes, but it was restored to 15 minutes pre-stretch, whereas the deficit in performance of muscle voluntary contraction (MVC) remained by 30, 45 and 60 minutes post-stretch.

Some studies which were reviewed in table 3 and 4 have also investigated the effect of static stretching on the amplitude of the muscle activity (EMG) parallel to the measurements of performance. Merely in eight investigations the performance deficit after static stretching was associated with a reduction in the muscle activity (Avela, Kyröläinen & Komi, 1999; Fowles et al., 2000; Young & Behm 2003; Cramer, Housh, Weir, Johnson, Coburn & Beck, 2005; Cramer, Massey, Marek, Danglemeier, Purkayastha, Culbertson, Fitz & Egan, 2007a; Marek, Cramer, Fincher, Massey, Dangelmaier, Purkayastha, Fitz & Culbertson, 2005; Sekir, Arabaci, Akova & Kadagan, 2010; Babault, Kouassi & Desbrosses, 2010). Thus, deficit in performance in these

studies were attributed to the reductions in the muscle activity. Changes in the amplitude of muscle activity happen due changes in the recruitment of motor unit action potential and their firing rate (Konrad, 2005). The mechanism in which static stretching reduces the muscle activity is the decreases in motor neuron pool excitability following stretching which may reduce peripheral muscle activation (Avela et al., 1999; Cramer et al., 2004; Cramer et al., 2007a). Further possible neural changes may be the decrement in the reflex sensitivity. Freiwald (2009) reported that static stretching has a psycho-physiologic relaxation effect through the inhibition of Hoffmann-reflex. It provides a measurement of motoneuronal excitability and of the synaptic transmission capacity from the Ia afferents to the motoneurons (Guissard & Duchateau, 2004). An inhibition in the reflex activity and a reduced spinal reflex excitability are expected in a stretched muscle. This inhibition can be registered by recording the tendon reflex (T-reflex) and the Hoffmann reflex by means of electromyography in a muscle such as m. soleus (Guissard & Duchateau, 2006). In the study of Avela et al. (1999) the decrement in maximal voluntary contraction by 23.2% was associated with a clear immediate reduction in the reflex sensitivity. Stretch reflex peak-to-peak amplitude decreased by 84.4% and the ratio of the electrically induced maximal Hoffmann reflex to the maximal mass compound action potential decreased by 43.8 %. In six studies there were merely decreases in performance but no changes in the electrical activity (Cornwell et al., 2002; Evetovich et al., 2003; Power, Behm, Cahill, Carroll & Young, 2004; Herda, Cramer, Ryan, McHugh & Stout, 2008; Ryan, Beck, Herda, Hull, Hartman, Stout & Cramer, 2008; Hough, Ross & Howatson, 2009). the reduction in performance in these studies were mostly related to the reductions in musculotendinous stiffness (Evetovich et al., 2003).

Just in one study the muscle activity decreased but no changes were registered in squat jump performance (Cornwell et al., 2002).

Conclusion: Static stretching does not always affect the muscle activity, and therefore the performance reduction after static stretching could not be completely explained through the decrement of the muscle activity.

2.3.6 Compensating the stretching-related deficits in performance

Just few investigations researched if the expected negative consequence caused from stretching exercises could be again compensated, and to find out which procedure would best suit in restoring this short-term stretching-related impairment of performance.

Hillebrecht et al. (2007) reported that short-term reduction of performance after stretching could be at least partly restored using suitable compensation procedures. Turbanski (2005) hypothesized that a motion sequence with maximum contractions after stretching must be performed before competing.

Taylor et al. (2009, p. 661) reported that “if a static stretching regime is used, it should be immediately followed by a sport-specific warm-up protocol in order to prevent any of the harmful effects associated with static stretching”. They found that netball-specific warm-up could compensate the loss of vertical jump and 20-m sprint performances which was affected from prior static stretching exercises when compared to dynamic stretching protocol followed by the same netball-specific warm-up.

Hillebrecht and Niedderer (2006) compared the ability of four procedures in restoring the reduction of the reactive force production of the legs in drop jump from 24-cm height following a static stretch. After stretching subjects (n=69) were divided into four groups, each group performed one of the following protocols: (a) three sets of ten consecutive maximal vertical jumps, (b) six maximal isometric contractions by knee angle 120°, (c) 3x40-m maximal sprints and (d) a rest for 30 minutes with no activity. Results showed significant positive effects in the sprint group (c) (the beginning performance before stretch was exceeded), and no change occurred in jump group (a), while the isometric contractions exercise in the group (b) resulted more decrease in drop jump performance.

In another study, Hillebrecht et al. (2007) found that the baseline performance of 50-m sprint before a bout of static stretching could not be longer reached after stretching followed by 2x50-m submaximum sprints. Taylor et al. (2009) investigated if a netball specific warm-up could compensate the loss of jump and sprint performances which was induced by 15 minutes static stretching. They also compared it with the effect of the same netball warm-up exercises following dynamic stretching. Their results revealed that static stretching condition resulted in significantly worse performance than the dynamic warm-up in vertical jump height (-4.2 %) and 20-m sprint time (1.4 %), but no significant differences in either performances were found when the netball warm-up was preceded by static stretching or a dynamic warm-up routine. Pearce, Kidgell, Zois and Carlson (2009) investigated if a secondary warm-up for 10-12 minutes consisted of some movement activity exercises (high knees run, side stepping, cross over, skip steps and zig-zag running) following static stretching can restore the deficit which happened in jump height and mean power performance in countermovement jump. Performances in both parameters were significantly decreased following static stretching (7.7 % and 2.4 %, respectively). After the second warm-up, movement activity exercises could not restore the decreased vertical jump height and the mean power remained significantly unchanged. Other studies investigated the effects of a combination of various exercises or activities prior to or following static stretching on the following performances. Young and Behm (2003) compared the effects of running, static stretching and practice jumps on explosive force production and jumping performance. 16 subjects performed squat jump and drop jump tests before and after four protocols in a randomized order: control, 4-min run, static stretching (four exercises for the plantar flexor and the quadriceps to the pain threshold with 30 seconds holding), 4-min run + static stretching and 4-min run + static stretching + jumps (one jump

at 80 % and three at 100 % of maximum effort). The results showed that the run + static stretching protocol was significantly lower than the run protocol, whereas practicing jumps after the static stretching produced greater mean results for squat jump (3.4 %) and drop jump height/time (7.1 %) compared with run + stretching protocol.

Vetter (2007) investigated the effects of six warm-up protocols on 30-m sprint and countermovement jump performances. The protocols were: a) Walk and run (WR) b) WR+ exercise series (toe raises, high knees lifting marching, buttocks kick marching and small jumps), c) WR + active dynamic stretching, d) WR+ active dynamic stretching + exercise series, e) WR + static stretching (four exercises with 30 seconds holding) + exercise series and f) WR + static stretching. There was no significant difference in sprint performances between all groups, whereas the jump performance was lower following (WR + static stretching) compared with the protocol (WR) and the protocol (WR+ active dynamic stretching + exercise series). All other comparisons were not significant. Wallmann et al (2008) investigated the effects of dynamic activity (continuous hopping with both legs for 1.5 minutes at a pace of about 60-100 jumps per minute), and dynamic activity combined with static stretching exercises of the gastrocnemius muscle (three sets of 30 seconds holding the stretch) on vertical jump performance in CMJ. The jump height in CMJ was not influenced in both conditions, and there was no difference between the two conditions. Sim, Dawson, Guelfi, Wallman and Young (2009) examined the effects of static stretching (20 seconds holding for hamstring, quadriceps and calf plantar flexors), static stretching followed by dynamic activities (2 x 15-m repeats each of buttock kicks, high-knee lifts, and straight leg skipping on a wooden gymnasium floor + 5 x 20-m run-throughs at progressively increasing speeds + three sets of 20 seconds standing leg swings of progressive intensity), dynamic activities followed by static stretching and dynamic activities only on repeated sprint performance. Sprint ability test consisting of three sets of maximal 6x 20-m sprints (going every 25 seconds) was used to measure the sprint performance. Results showed that sprint performance was slowest in the dynamic activities + static stretching than the other two conditions, whereas there was no sig. differences between the static stretching + dynamic activities and dynamic activities only. In the study González-Rave, Machado, Navarro-Valdivielso and Vilas-Boas (2009), the effects of heavy load resistance exercises (three sets of four repetitions of half squat at 85 % of 1-RM), heavy load resistance exercises + three static stretching exercises (three exercises with holding the stretch for 15 seconds for the hamstring, quadriceps and calf muscles), or only static stretching were studied on jump height of the squat jump and in countermovement jump. No significant differences in jump height between the groups. There was an increase in SJ and CMJ jump heights, but these results were not significantly different from all other scores.

Conclusion: Most of the investigated exercises in the reviewed studies were not able to restore performance which was affected from preceded static stretching. The several possible variations of modes, intensities, repetitions, recovery periods and durations of

exercises as well as the way of testing performance show a huge lack of knowledge to this problem. Therefore, more investigations are needed.

2.3.7 The aim of the investigations in this thesis

Despite the fact that athletic performance could be negatively affected following static stretching, especially force, power and sprint performances, many athletes still implicate static stretches in their warm-up program. According to the recent studies which were reviewed in table 3, various athletic performances were reduced following a preceded static stretching. On the other hand several studies reported equivocal effects (studies in table 4). Therefore, all studies in this thesis aimed primarily to investigate if any deficits in performances (isokinetic force in the first study, horizontal jump performance in the second study and vertical jump performance in the third study) occur following a static stretching program. In fact, this problem was already numerously investigated in the literature. However, the analysis of many studies showed conflicting results. A lot of studies have registered no changes in performance following static stretching. Therefore, it was necessary to examine if performance-deficits actually occurred in the studies of this thesis by implication a post-stretch measurement directly following stretching, despite the possible confounding effect of this measurement on the final result (following the second treatment). The first study also investigated the acute effects of dynamic stretching on isokinetic peak torque as well as the effect of both stretching types on hip maximal range of motion. In the second and third study it was also investigated if some suggested activation exercises could compensate the expected reduction in performance and thereby athletes can implicate these exercises directly following the static stretching to avoid any possible reductions in performance before training or competition. The ability of certain exercises in compensating performance-deficits following static stretching was not sufficient investigated in the literature. The selected exercises were the maximal jumps, dynamic half squats, isometric squats (in the second study) and weighted jumps (in the third study). The exercises were chosen based on the analysis of table 1, in which recent studies have investigated the ability of various exercises to induce the postactivation potentiation were reviewed. In order to realize the effects of stretching as well as the effects of the activation exercises, various performances were tested. Isokinetic force performance (peak torque and joint angle at peak torque) in the first study, horizontal jump performance (triple-hop jump) in the second study and the vertical jump performance (counter-movement jump) in the third study, were measured. Measurement of electromyography was also applied in the third study in order to realize any possible changes in the electrical properties of the investigated muscles and may help to give a theoretical interpretation for the results. All studies in this thesis are controlled and randomized.

3 First study: Acute effects of static and dynamic stretching on isokinetic force and flexibility

3.1 Introduction

A number of recent studies researched the acute effects of static stretching on isokinetic force performance. Nelson et al. (2001a) investigated the effect of an acute stretching regimen on isokinetic knee extension peak torque for the dominant leg at five specific movement velocities (1.05, 1.57, 2.62, 3.67, and 4.71 rad/second). Poststretch maximal torques at 1.05 and 1.57 rad/second (low velocities) were significantly reduced (-7.2 %, -4.5 %, respectively), but at high velocities (2.62, 3.67, and 4.71 rad/second) maximal torques remained unaltered. Evetovich et al. (2003) registered a significant decrease in isokinetic concentric peak torque of arm flexor following static stretching of the m. biceps brachii at both 30 and 270 °/second angular velocities. Cramer et al. (2004), Cramer et al. (2005), Cramer et al. (2007a), Marek et al. (2005) and Siatras et al. (2008) observed significant decreases in isokinetic concentric peak torque of leg extensor following static stretching at both slow and fast angular velocities (60 and 240 °/second, 60 and 240 °/second, 1.04 and 5.23 rad/second, 60 and 180 °/second and 60 and 300 °/second, respectively). Costa et al. (2009) investigated the acute effects of hamstring and calf stretching on isokinetic leg extension and flexion peak torque and the hamstrings-to-quadriceps ratio during maximal, concentric isokinetic muscle actions at 60, 180, and 300 °/second in women. The results indicated that leg flexion peak torque decreased from pre- to post-stretching, but no other changes were observed from following stretching for leg extension peak torque and the hamstrings-to-quadriceps ratio. Many other studies reported equivocal effect of static stretching on isokinetic force. Isokinetic peak torques remained unaltered following static stretching in the studies of Cramer et al. (2006) (leg extensor), Cramer et al. (2007b) (leg extensor), Egan et al. (2006) (leg extensor), Manoel et al. (2008) (leg extensor), Nelson et al., (2001a) (leg extensor), Samuel et al. (2008) (leg extensor and flexor) and Winke et al., (2010) (leg flexor) at angular velocities of 60 and 180 °/second, 60 and 180 °/second, 60 and 180 °/second, 2.62, 3.67, and 4.71 rad/second, 60 °/second and 60 and 210 °/second, respectively. The acute effect of dynamic stretching on isokinetic force was insufficient investigated in the literature. Sekir et al. (2010) compared the effect of static and dynamic stretching of the leg flexors (hamstring) and extensors (quadriceps) on concentric and eccentric, flexion and extension peak torque at 60 and 180 °/second in female athletes. Their results indicated that all measured peak torque parameters were significantly decreased immediately following static stretching, whereas dynamic stretching improved all isokinetic force parameters, with the exception of concentric peak torque of hamstring at 180 °/second. Manoel et al. (2008) examined the acute effect of static, dynamic and proprioceptive neuromuscular facilitation (PNF) on isokinetic concentric peak torque in women of the leg ex-

tensor at 60 and 180 °/second. None of the stretching types caused a decrease in knee extension performance. However, dynamic stretching produced increases in performance at both testing velocities. Herda et al. (2008) examined the acute effects of static versus dynamic stretching on voluntary isometric peak torque of leg flexion at knee joint angles of 41°, 61°, 81° and 101°. The results revealed that peak torque decreased after the static stretching at 81 ° and 101° but not at other angles, whereas performance did not change following the dynamic stretching.

Just few studies aimed to explore if any alternations may occur following stretching in joint angle at which maximal force production occur. The studies of Cramer et al. (2005) and Cramer et al. (2007a) observed that the stretching-induced reductions in concentric isokinetic peak torques of the leg flexor were not associated with changes for the angle at peak torque at slow and fast velocities, as well as in the study of Cramer et al. (2007b) no changes were reported in eccentric isometric peak torque nor in angle at peak torque.

The effect of static and dynamic stretching on peak torque of leg flexor was insufficient investigated. It was also not investigated if any improvement in performance following dynamic stretching was associated with improvement in joint range of motion, what athletes need for their activities about to perform. Therefore, this study was designed to investigate the acute effects of hamstring static and dynamic stretching on peak isokinetic concentric torque at slow angular velocity (60 °/second), the knee angle, at which this peak torque occurs, and the hip flexion range of motion.

This study aimed to find answers to the following questions:

- Which acute effects have the static and dynamic hamstring stretching on the following peak isokinetic force of the leg flexor?
- Do static or dynamic hamstring stretching alter the joint's angle, at which the peak isokinetic torques occur?
- Is there any difference between hamstring static and dynamic stretching regarding the short-term improvement in hip flexion joint flexibility?

3.2 Methods

3.2.1 Subjects

17 active sport students, men (n = 12) and women (n = 5) participated in this study. The students were physically active either for their sport study or for fitness purposes. The descriptive characteristics are found in table 5. Each individual declared themselves free of any history of hip, knee or ankle problems and signed a written informed consent prior to testing. Subjects were recruited based on their participation in a research seminar in their sport study at the Sport Science Institute of Saarland University (Germany).

Table 5: Descriptive statistics (mean $M \pm$ standard deviation SD) for age, height and mass of the subjects ($n=17$)

	Men (n=12)	Women (n=5)
	$M \pm SD$	$M \pm SD$
Age (year)	22.5 ± 1.5	21.4 ± 0.9
Height (cm)	183 ± 6	167 ± 10
Mass (kg)	81.2 ± 8	57.4 ± 10

3.2.2 Variables

Measurement of isokinetic force

Isokinetic is “a muscular action performed at constant angular limb velocity” (Fleck & Kraemer, 2004, p. 33). Many studies revealed that isokinetic strength has a strong relationship to various athletic performances. Brown (2000) reviewed a number of studies demonstrated the correlation between isokinetic strength and various athletic performances and reported that 60 studies registered correlations of 0.5 or higher between isokinetic strength and athletic performances such as jumping (23 studies), sprinting (16 studies), throwing (nine studies), kicking (five studies), swimming (six studies) cycle anaerobic ergometer tests (18 studies) and other performances (six studies), whereas just in eight studies no correlations could be found. Isokinetic force measurements have a high technical accuracy and reliability (Brown, 2000; Gore, 2000). However, eccentric contractions appear to have lower reliability than concentric contractions, and tests at slower velocities appear to have more reliability than test at faster velocities (Gore, 2000). The isokinetic measurements in the present study were carried out using an isokinetic dynamometer (Kintrex 1000 from the company Meditronic Instruments SA, Switzerland¹). Subjects were seated on the machine in a 90° angle between trunk and thigh and in a 90° knee flexion. For every subject, the sitting position as well as the length of the rotation axis of the dynamometer were adjusted to suit individual body differences between subjects, and notated in order to apply the same settings at further testing sessions. The trunk, hips and thighs of both legs were well fastened with belts in order to deactivate any impact of their movements on the right leg flexion. The arms were crossed over the chests. The right lower leg was fixed to the rotation axis of the dynamometer five centimeter over the ankle joint. The range of motion during the isokinetic test was set between full leg extension (0°) and (90°) knee flexion. Before each isokinetic force measurement, gravity corrections for limb mass were performed as it was instructed from the manufacturer. The gravity corrections consisted of a passive extension and flexion. The aim of this procedure was to measure

¹ Fig. 1 in appendix

the mass of the right leg so that the software automatically truncate it from the force value. Then, five light extensions and flexions at $110^\circ/\text{second}$ were performed in order to habituate to the isokinetic force measurement. After 30 second resting time, five consecutive maximal repetitions were performed. Every repetition began from the flexion position with a light extension at $110^\circ/\text{second}$ angular velocity followed by a maximal flexion at $60^\circ/\text{second}$ angular velocity. Subjects were instructed to accomplish the flexion as quick and strong as possible along the whole range of motion. During isokinetic test, subjects were verbally encouraged and supplied with visual feedback of their force values. Repetitions with failure were excluded directly at the end of the measurement from the investigator. Then, data were exported into a statistic program (Statistica 10) for further evaluation. Torques at each knee angle in all valid repetitions were averaged in order to calculate the peak torque (Nm) and the angle at peak torque ($^\circ$).

Measurement of hip flexion range of motion

Following the isokinetic tests, measurements of hip flexion range of motion with a straight leg were applied in order to compare the efficiency of static and dynamic stretching in improving hip flexibility (short-term effects). Subjects laid supine, and their shoulders and trunk as well as the left leg were well fastened with belts. The right leg was connected with a cable at the ankle joint, and the cable moved on a pulley fixed on the wall behind the subjects so that they could pull the cable with their arms. The task of the test was to pull the cable and thereby the right leg until the maximal range of motion was reached. Subjects had to keep their right leg passively straight at the sagittal plane during the measurement. Once the maximal range of motion was reached, the range of motion was measured using a digital goniometer (from the company Nedo, Germany) placed over the tibia bone.

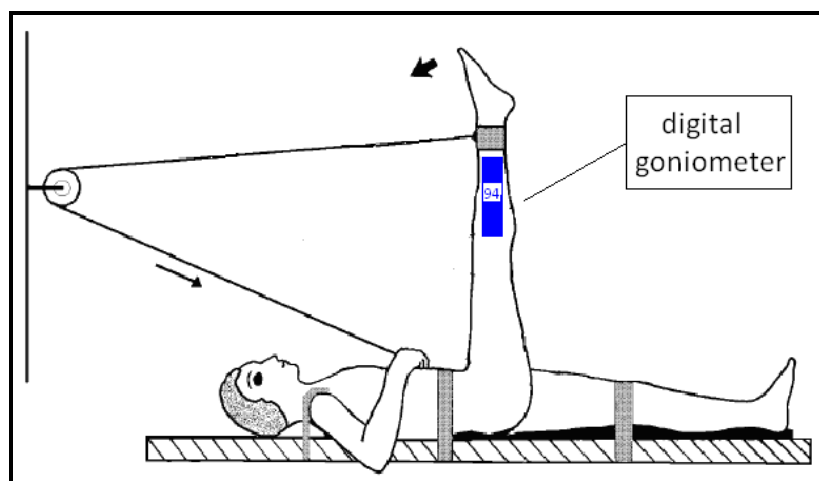

Figure17: Measurements of hip flexion range of motion (adapted from Glück, 2005, p. 63)

3.2.3 Treatments

The stretching exercises consisted of three sets of four stretches that were chosen intended to passively stretch the hamstring muscle group. The exercises were performed either statically with a 30 second holding the stretch at the point of discomfort and 15 seconds resting between sets (protocol A), or dynamically with 12-14 slow repetitions of swinging with small-amplitude till the point of discomfort (protocol B). Each dynamic stretching set lasted 30 seconds (approximately 2.5 seconds per repetition) for the right hamstrings (figure 18).

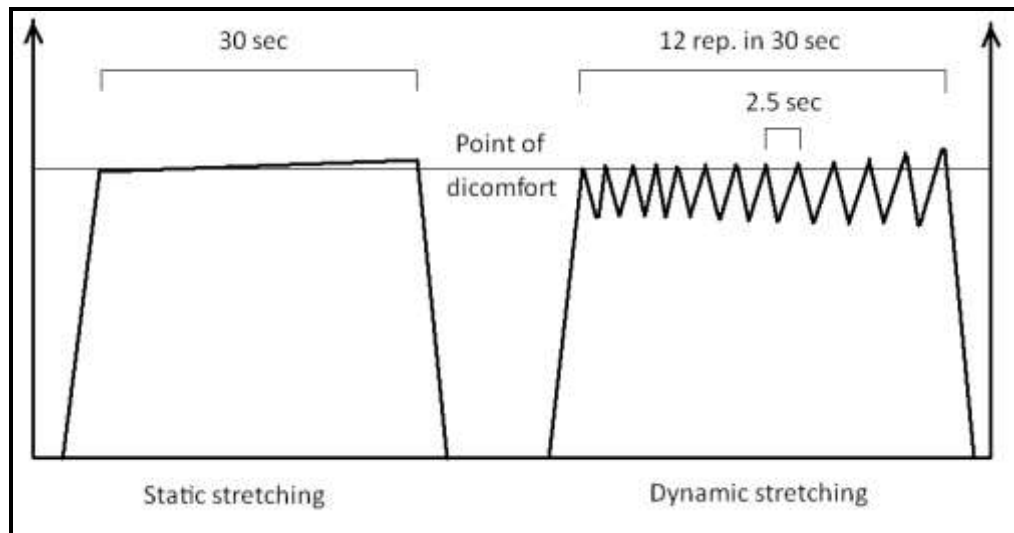

Figure 18: The rhythm and amplitude of accomplishing the stretching exercises of the first study in a static or dynamic type.

The chosen exercises² were:

1. Lying hip flexion: the first exercise was performed with the same settings used in the measurement of hip range of motion. Subjects pulled the cable till the point of discomfort. Then, this position was kept for 30 second (protocol A), or subjects pulled and relaxed the cable in alternation (protocol B).
2. Lying hamstring stretch: subjects lied supine on a sport mat and lifted their right leg upward (90°). Then, subjects pulled the bottom of the right foot toward shoulders using an inelastic band till the point of discomfort. Then, this position was kept for 30 second (protocol A), or subjects pulled and relaxed the band in alternation (protocol B).
3. Standing hamstring stretch (1): subjects crossed their legs so that the right leg remained straight behind the left leg. Then, subjects flexed their trunk slowly forward and spread the arms toward the toes till the point of discomfort. Then, this

² Fig. 2 in appendix

position was kept for 30 second (protocol A), or subjects performed small-amplitude forward-backward trunk movements in alternation (protocol B).

4. Standing hamstring stretch (2): subjects placed the right foot on a seat, and stood on the left leg which was slightly flexed, and then leaned the trunk forward till the point of discomfort. This position was kept for 30 seconds (protocol A), or subjects performed small-amplitude forward-backward trunk movements in alternation (protocol B).

3.2.4 Study design

Before starting with the testing sessions, participants performed two standardized familiarization sessions served the habituation to the isokinetic and flexibility measurements of the study as well as to the static and dynamic stretching exercises. These training sessions included the same protocol of the isokinetic measurement and stretching exercises about to perform in the following testing sessions. Subjects were given standardized instructions to the proper execution of isokinetic force measurement. Thereafter, subjects attended a total of four testing sessions so that the four test days were consecutively at the same weekday and the same time of day. Subjects were randomly divided into four groups (A, B, C and D) so that the order of the protocol assignment was randomized per person (within-subject design). The protocol (C) was set as a control condition with force and flexibility tests, whereas the protocol (D) was set as a second control condition without performing the flexibility test in order to exclude any confounding effect of this test on the following force performance (see table 6). In both control conditions, subjects had ten minutes of passive sitting. Each session started with an initial warm up period of five minute cycling by $1.5 \times$ body weight (watt) on a cycloergometer (Bosch ERG 550). All warm up exercises with subsequent data-collection and testing occurred in a laboratory of the Sport Science Institute of the Saarland University (Germany).

Table 6: Tests and treatments order in the first study.

Protocol	Baseline tests	Treatment	Post-test
A	force + flexibility	static stretching	force + flexibility
B	force + flexibility	dynamic stretching	force + flexibility
C	force + flexibility	10 min rest (control 1)	force + flexibility
D	force	10 min rest (control 2)	force

3.2.5 Hypothesis

The following hypotheses were formulated:

Hypothesis 1: Static and dynamic hamstring stretching have different effects on isokinetic concentric leg flexor peak torque.

Hypothesis 2: Static and dynamic hamstring stretching alter the knee angle at peak torque.

Hypothesis 3: Static and dynamic hamstring stretching enhance the hip range of motion.

3.2.6 Statistical analyses

Descriptive statistics: mean (M) \pm standard deviation (SD) for age, height, mass and for the measured variables were calculated. A Kolmogorov–Smirnov test showed that all data were normal distributed³. Repeated measures analysis of variance ANOVA was used to analyze differences between criterion measures following the various protocols. When a significant *p* value was achieved, post hoc comparisons were accomplished via contrast analysis to identify specific differences between criterion measures or testing sessions. Statistical significance was set at $p \leq 0.05$, and all analyses were carried out using Statistica (version 10, Tulsa, Oklahoma). The Cohen's effect sizes were calculated using an effect size calculator in a web-site of the faculty of philosophy of the Saarland University⁴.

3.3 Results

3.3.1 Test-retest reliability

The test-retest reliability coefficients were calculated between baseline measurements of peak torque, angle at peak torque and hip range of motion in all four conditions⁵. Coefficients ranged between 0.90 and 0.95 for the measurements of peak torque and between 0.85 and 0.98 for the measurements of hip range of motion, and all values were significant. However, the correlations between baseline measurements for the angle at peak torque were weak and mostly not significant.

³ Tab. 1 in appendix

⁴ Created by Bernhard Jacobs: retrieved 03.06.2011. from <http://www.phil.uni-sb.de/~jakobs/seminar/vpl/bedeutung/effek-tstaerketool.htm>

⁵ Tab. 2, 3 & 4 in appendix

3.3.2 Isokinetic peak torque

Means and standard deviations of isokinetic peak torque across the four protocols are shown in table 7.

Table 7: Means \pm standard deviations of isokinetic peak torques (Nm) across the four conditions and the two test-times.

Treatment	Baseline M \pm SD (Nm)	Post-test M \pm SD (Nm)
Static stretching	97 \pm 26	91 \pm 25
Dynamic stretching	99 \pm 29	92 \pm 28
Control 1	101 \pm 31	97 \pm 33
Control 2	101 \pm 31	99 \pm 28

A repeated-measures analysis of variance showed no significant differences for the peak torque between the four conditions of this study ($p=0.088$, $F=2.3$), but a significant test-time effect from baseline to post-test ($p=0.006$, $F= 9.9$), however, the interaction (condition * test-time) was not significant ($p=0.474$, $F= 0.85$).

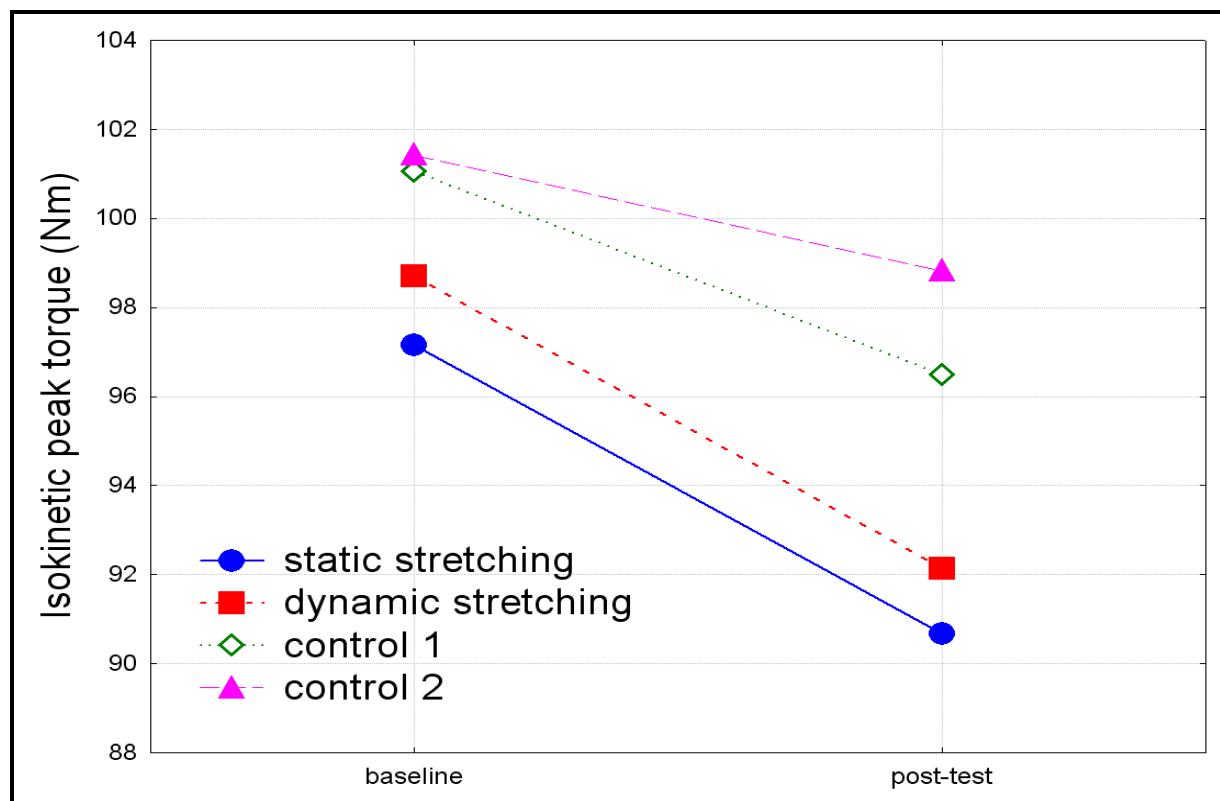

Figure 19: The effects of static stretching, dynamic stretching and rest on isokinetic peak torque.

3.3.3 Angle at peak torque

Means and standard deviations of angle at peak torques across the four protocols are shown in table 8.

Table 8: Means \pm standard deviations of angle at peak torque ($^{\circ}$) across the four conditions and the two test-times.

Treatment	Baseline M \pm SD ($^{\circ}$)	Post-test M \pm SD ($^{\circ}$)
Static stretching	36 \pm 10	33 \pm 8
Dynamic stretching	33 \pm 10	31 \pm 11
Control 1	36 \pm 13	36 \pm 13
Control 2	35 \pm 10	34 \pm 8

A repeated measure two-way analysis of variance showed no significant difference for the angle at peak torque between conditions ($p=0.62$, $F=0.59$), no significant changes for the test-times from baseline to post-test ($p=0.22$, $F=1.6$), and the interaction (condition * test-time) was also not significant ($p=0.59$, $F=0.63$).

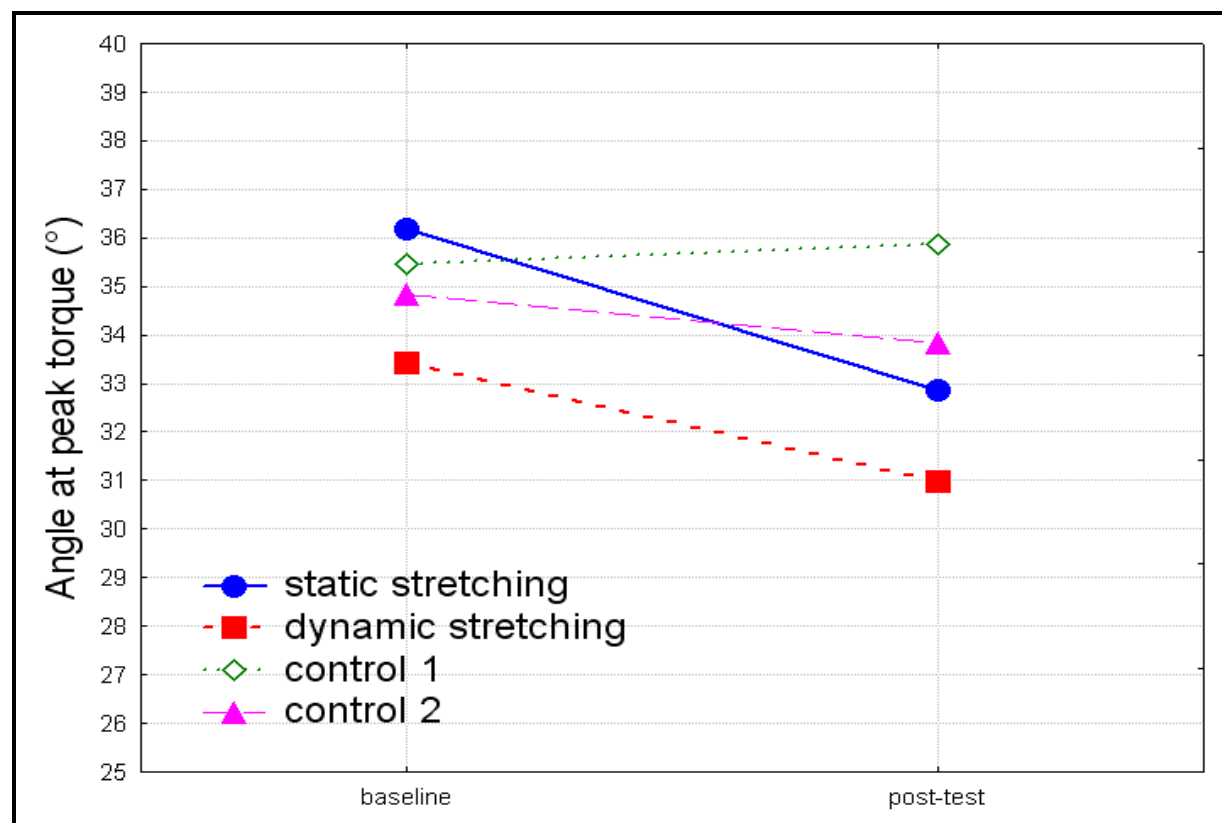

Figure 20: The effects of static stretching, dynamic stretching and rest on angle at peak torque.

3.3.4 Hip flexion range of motion

Means and standard deviations of hip range of motion across three protocols are shown in table 9.

Table 9: Means \pm standard deviations of hip flexion range of motion ($^{\circ}$) across three conditions and the two test-times.

Treatment	Baseline M \pm SD ($^{\circ}$)	Post-test M \pm SD ($^{\circ}$)
Static stretching	99 \pm 14	107 \pm 17
Dynamic stretching	99 \pm 15	111 \pm 18
Control 1	103 \pm 15	105 \pm 16

A repeated measure two-way analysis of variance for the hip flexion range of motion showed no significant difference between conditions ($p=0.352$, $F=1.08$), but significant changes for the test-times from baseline to post-test ($p=0.000$, $F=76.4$), and the interaction (condition * test-time) was significant ($p=0.000$, $F=12.03$). Post hoc contrast analyses showed that hamstring static and dynamic stretching enhanced the hip flexion range of motion significantly $p=0.009$, $F=8.6$, $ES= 0.37$ and $p=0.000$, $F=33.7$, $ES=0.55$, respectively, when compared to the control condition (control 1).

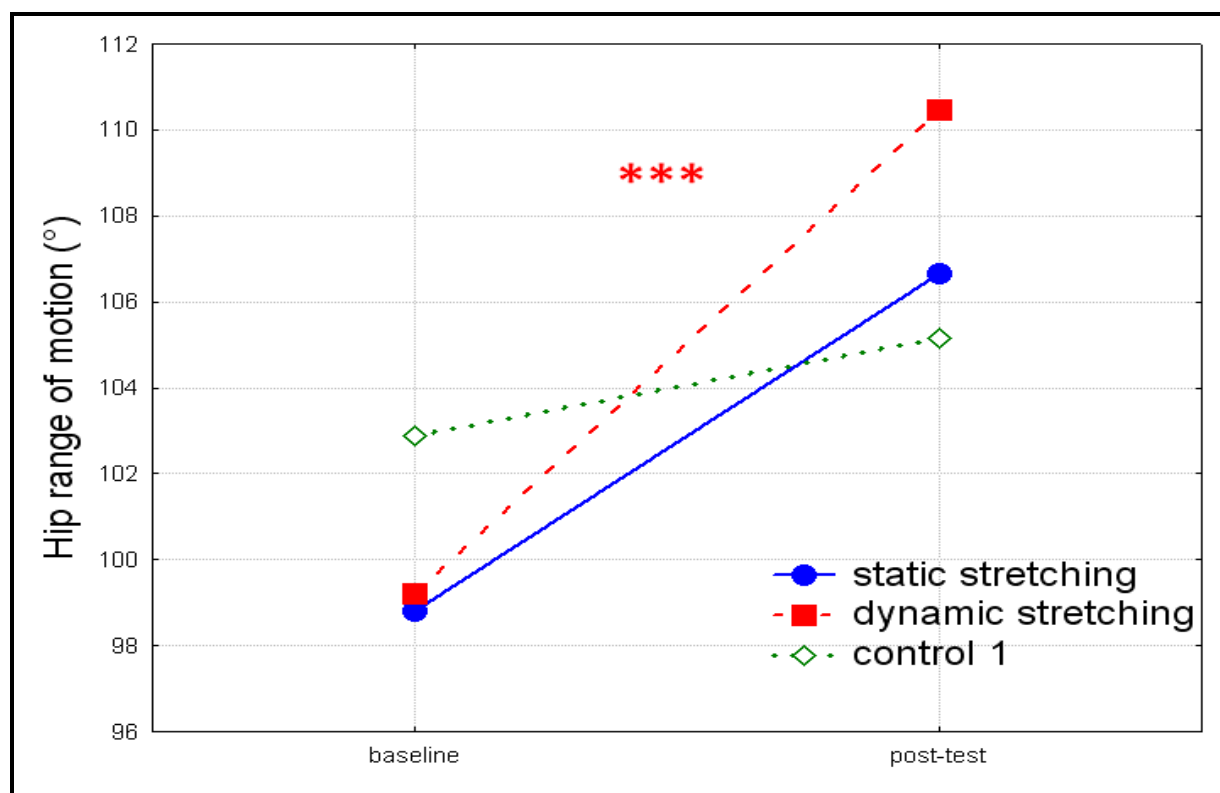

Figure 21: The effects of static stretching, dynamic stretching and rest on hip flexion range of motion.

3.4 Discussion

The result of the present study indicated no stretch-induced impairment in concentric isokinetic leg flexion following a hamstring static stretching program consisted of four passive stretches with a prolonged duration. These findings are consistent with previous studies in which no change in isokinetic force was registered (Cramer et al., 2006; Egan et al., 2006; Manoel et al., 2008; Nelson et al., 2001a, Samuel et al., 2008 & Winke, 2010). On the other hand, isokinetic concentric peak torques of leg extensor at both low and high velocities were decreased following static stretching in the studies of Cramer et al. (2004), Cramer et al. (2005), Cramer et al. (2007a), Marek et al. (2005) and Siatras et al. (2008). The conflicting results of various studies investigated the acute effects of static stretching on isokinetic force at high and low velocities may be related to some unknown or unintended differences in stretching intensities between protocols (Cramer et al., 2005). The problematic of determination the intensity of a stretch is that subjective feeling of the subjects were used to determine the stretch intensity. The duration of holding the stretch may also influence the results. In the study of Siatras et al. (2008), stretching-induced reduction in performance was only observed following a static stretching exercise with 30 and 60 seconds holding the stretch, whereas no changes occurred with stretching durations of 10 and 20 seconds.

The dynamic stretching in the present study showed neither impairment nor facilitation in the following isokinetic force. Some previous studies have also registered no improvements in leg extensor and flexor concentric isokinetic peak torque (Samuel et al., 2008), leg flexion isometric peak torque (Herda et al., 2008), or vertical jump performance in countermovement and squat jumps (Unick et al., 2005). However, according to literature related to the acute effect of dynamic stretching, the majority of studies reported facilitations in subsequent sprint, jump and isokinetic force performances such as in the investigations of Fletcher and Anness (2007), Hough et al. (2009), Little and William (2006), Manoel et al. (2008), Pearce et al. (2009), Sekir et al. 2010 and Yamaguchi et al. (2008). The mechanism in which dynamic stretching enhance subsequent performances may be related to the improvement in central programming of muscle contraction/coordination and decreased fatigue through increased warm-up activity (Shrier, 2007).

There was no significant change in the joint angle at which the isokinetic peak force occurred in the present study. However, test-retest reliability for the angle at peak torque was weak and mostly non significant. Thus, this result can be considered as non-meaningful. The angle at peak torque remained also unaltered following static stretching in the study of Cramer et al. (2005) and Cramer et al. (2007a) although the isokinetic force was reduced, as well as in the study of Cramer et al. (2007b). Any alternation in angle at peak torque may refer to an increase in muscle length (Wydra & Glück, 2004; Wydra, 2006). Developing a maximum force of a muscle depends on the extent of overlap of actin and myosin filaments. When the actin and myosin filaments overlap optimally in a middle stretching degree, the number of cross-bridges reach its

maximum and thereby a maximum contraction force can be developed. This muscle length in which the maximum force can be developed is called “optimal length”. The more the muscle straws from its optimal length, the less is the overlap of actin and myosin filaments and the smaller is the contraction force (Klee & Wiemann, 2004a).

Both static and dynamic stretching enhanced the hip flexion range of motion. The enhanced joint flexibility following stretching can be attributed to the familiarization to pain by improving the one’s tolerance to the maximum stretching tension (Klee & Wiemann, 2004b). Hamstring stretching can also enhance the knee range of motion. Cronin et al. (2008) registered an enhancement in knee range of motion following three stretches of hamstring held for 30 seconds. In the present study, there was no difference between static and dynamic stretching in enhancing the hip flexion range of motion. This result is consistent with the findings of Perrier, Pavol and Hoffman (2011). However, according to the evaluation of various investigations in the study of Klee and Wiemann (2004a), both stretching types improved flexibility (short-term effect), but dynamic stretching is more efficient than static stretching.

Conclusion: Static and dynamic hamstring stretching enhanced the hip flexion range of motion with neither impairment nor facilitation in isokinetic concentric knee flexion force at low velocity.

4 Second study: Acute effects of static stretching followed by various activation exercises on jump performance in triple-hop

4.1 Introduction

The results of the first study indicated no performance-deficit in isokinetic force following a static and stretching program. It was necessary to select another performance criterion in which stretching-related impairments in performance almost certainly occur, in order to achieve the main purpose of this thesis which was to find out which activation exercise could compensate these impairments. Therefore, the triple-hop test was selected in the current study as a performance-criterion according to the result of a pre-experiment which aimed to find out which jump test is strongly affected from a static stretching program. Four horizontal and vertical jumping tests were examined before and following three sets of four static stretches. The examined tests were: countermovement jump, drop jump, triple-jump and triple-hop tests. The result of the pre-experiment showed that triple-jump and triple-hop performances were reduced by 10 % ($p=0.003$, $ES=0.87$) and 14 % ($p=0.0004$, $ES=1.13$), respectively, whereas the reductions in countermovement and drop jumps were found to be non significant. Triple-hop jump is a simple way to measure lower body power in horizontal rather than vertical movements (Gamble, 2010).

A number of recent investigations have reported a temporary reduction in jump performance following static stretching. However, few studies have examined the acute effects of static stretching on horizontal jumping performance. Faigenbaum et al. (2005) compared the acute effects of three different warm-up protocols (static stretching, dynamic exercise or dynamic exercise plus three drop jumps) on horizontal long jump performance in children. The results indicated that long jump performance was significantly reduced following static stretching as compared to dynamic exercise plus three drop jumps. In another study, Faigenbaum, McFarland, Schwerdtman, Ratamess, Kang and Hoffman (2006) reported that the long jump performance was significantly greater following dynamic exercises with a vest weighted with 2 % of body mass than following static stretching.

The ability of certain exercises in compensating performance-deficits following static stretching was insufficient investigated in the literature. It was hypothesized in this investigation that maximal jumps, light dynamic or static squat could compensate the impairment in triple-hop performance decreased following static stretching. The selection of these exercises was occurred according to the analysis of studies investigated the acute effects of postactivation potentiation in table 1.

The effects of eight different warm-up protocols on horizontal jump performance in triple-hop test were compared in this investigation. The eight warm-up protocols consisted of moderate-intensity, dynamic and isometric exercises or rest, with and without

prior static stretching. It was also hypothesized that these exercises could be able to restore performance which is negatively affected following a bout of static stretching. This investigation aimed to find answers to the following questions:

- Would in this study the jumping performance be affected by static stretching exercises as the results of many other previous investigations?
- Which procedure would best suit in restoring the expected decrement of jumping performance following a bout of static stretch?
- Which of the investigated exercises in this study -with or without stretch- would best suit in the warm-up before a training or competition?

4.2 Methods

4.2.1 Subjects

Twenty active sport students, men ($n = 12$) and women ($n = 8$) participated in this study. The students were physically active either for their sport study or for fitness purposes. The descriptive characteristics are found in table 10. Each individual declared themselves free of any history of hip, knee or ankle problems and signed a written informed consent prior to testing. Students were recruited based on their participation in a research seminar in their sport study at the Sport Science Institute of Saarland University (Germany).

Table 10: Descriptive statistics (mean $M \pm$ standard deviation SD) for age, height and mass of the subjects ($n=20$) in the second study.

	Men ($n=12$)	Women ($n=8$)
	$M \pm SD$	$M \pm SD$
Age (year)	24.33 ± 4.83	21.6 ± 1.4
Height (cm)	180 ± 6	170 ± 7
Mass (kg)	76 ± 7	63 ± 10

4.2.2 Variables

Measurement of jump distance in the triple-hop test

Triple hop test is a strong positive predictor of performance on clinical power and strength, and a valid test of lower limb power and strength (Hamilton, Schmitz & Perrin, 2008). Hamilton et al. (2008) investigated the validity of triple-hop test in accurately predicting lower limb (hamstring and quadriceps) strength and reported that triple-hop test is a strong predictor of isokinetic force at slow ($60^\circ/\text{second}$) or high ($180^\circ/\text{second}$)

°/second) angular velocities. The purpose of this test is to measure lower body power in a horizontal rather than vertical movements such as in countermovement or squat jump (Gamble, 2010). The advantages of this test are that it requires minimal space, time and equipment (Hamilton et al. 2008). In the present study, subject stood with the toe of the jump leg at the jump line. The other leg (swing leg) was located behind it unloaded in normal step position. The subject was asked to perform three consecutive leg hops on the same leg (jump leg) as far as possible (Swing movements when starting are only so far permitted, when thereby the foot of the jump leg was not lifted from the floor). The landing after the third jump was either on one or two legs into the sand⁶. The measurement of jump distance was taken from take-off line to the nearest point of contact on the sand of the third jump. The best score of the three trials was recorded to the nearest centimeter (Fetz & Kornexl, 1993). Trials with wrong execution or with any deviation from proper technique of triple-hop such as slow hops were directly excluded from the researcher. The reliability of this test can be influenced from the subjects' familiarity with the movement (Markovic & Jaric, 2004; as cited in Gamble, 2010). For this reason, the subjects of the current study practiced triple-hop trials in three separate familiarization sessions in order to minimize the carry-over and familiarization effects of this test.

4.2.3 Treatments

Maximal jumps (JU)

Subjects performed three trials of the triple-hop test prior to and immediately after three sets of ten consecutive maximal vertical jumps. A rest period of 50 seconds was imposed between the sets for recovery.

Dynamic half squat (SQ)

Subjects performed three trials of the triple-hop test prior to and immediately after three sets of eight dynamic half back squats with 50 % of their body weight. All repetitions were executed as quickly as possible⁷. A rest period of 50 seconds was imposed between the sets.

Isometric squat (ISO)

Subjects performed three trials of the triple-hop test prior to and immediately after three sets of ten seconds isometric-squat exercise by 120°knee angle with 50 % of their body weight⁸. A rest period of 50 seconds was imposed between the sets.

⁶ Fig. 3 in appendix

⁷ Fig. 4a in appendix

⁸ Fig. 4b in appendix

Rest (control 1)

Subjects performed three trials of the triple-hop test prior to and after three minutes rest with no activity.

Static stretching + maximal jumps (SS+JU)

Subjects performed three trials of the triple-hop test prior to and immediately after static stretching (SS) and once again after three sets of ten consecutive maximal vertical jumps as previously described in (JU). The stretching exercises consisted of seven minutes of four various static stretching exercises performed with a 30 second hold at the point of discomfort. The chosen stretches were intended to passively exercise muscle groups strongly involved in the triple-hop. The chosen exercises⁹ were:

1. Standing single leg quadriceps stretch: in a standing position with one flexed leg was pulled with the hand (2 sets x 30 seconds).
2. Seated single leg gastrocnemius and hamstring stretch: in a seated position the toes of one foot were pulled while the same leg kept straight (2 sets x 30 seconds).
3. Lying single leg gluteus maximus stretch: in a lying position the flexed-medial-rotated leg was pulled to the chest direction (2 sets x 30 seconds).
4. Seated double leg straight legs toe touch: in a seated position with both legs straight, the upper body was flexed forward and the arms were straighten to reach the toes (2 sets x 30 seconds)

Static stretching + half squat (SS+SQ)

Subjects performed three trials of the triple-hop test prior to and immediately after the same stretching exercises and once again after three sets of eight dynamic half back squats as it is described in (SQ).

Static stretching + isometric squat (SS+ISO)

Subjects performed three trials of the triple-hop test prior to and immediately after the same stretching exercises and once again after three sets of ten seconds isometric strength exercise as it is described in (ISO).

Static stretching + rest (SS+REST)

Subjects performed three trials of the triple-hop test prior to and immediately after the same stretching exercises (SS) and once again after three minutes rest with no activity.

4.2.4 Study design

Before starting with the jump measurements participants performed three separate standardized familiarization sessions. Each session included a minimum of 15 trials of triple-hop, in addition to one of the (JU), (SQ) and (ISO) protocols aimed to habituate

⁹ Fig. 5 in appendix

to the triple-hop test and the jump and strength exercises of the experiment to eliminate the carry-over effects. Then, participants attended a total of 8 data collection sessions (within-subject design) and were completed during one month, so that minimum 48 hours separated each test day. Each session started with an initial warm up period of ten minutes running with approximately 120-140 BPM heart rate, followed by the pre-test (see table 11). The order of the protocol assignment was randomized per person. All warm-ups and exercises with subsequent data collection and testing occurred in an indoor athletic track and field.

Table 11: Tests and treatments order in the second study

Treatment	1	2	3	4	5	6
JU	10-min running	3 x triple-hop-test	consecutive jumps	3 x triple-hop-test	-	-
SQ			dynamic squats		-	-
ISO			isometric squat		-	-
REST			3 min rest		-	-
SS+ JU			static stretching		consecutive jumps	3 x triple-hop-test
SS+ SQ			static stretching		dynamic squats	
SS+ ISO			static stretching		isometric squat	
SS+REST			static stretching		3 min rest	

4.2.5 Hypothesis

The following hypotheses were formulated:

Hypothesis 1: Jump distance following static stretching exercises is significantly decreased.

Hypothesis 2: Jumping, static or dynamic squat exercises can restore the decrement in jump distance which was negatively decreased following the static stretching.

Hypothesis 3: Jump distance following jumping, static or dynamic squat exercises without prior static stretching is better than following the same exercises with prior static stretching.

4.2.6 Statistical analyses

Descriptive statistics: mean (M) \pm standard deviation (SD) for age, height, mass, and the variables in addition to the differences between the three test times were calculated. A Kolmogorov–Smirnov test showed that all data were normal distributed¹⁰. Repeated measures analysis of variance ANOVA was used to analyze differences between criterion measures following the various warm-up protocols. When a significant p value was achieved, post hoc comparisons were accomplished via contrast analysis to identify specific differences between criterion measures or testing sessions. Statistical significance was set at $p \leq 0.05$, and all analyses were carried out using Statistica (version 10, Tulsa, Oklahoma). The Cohen's effect sizes were calculated using an effect size calculator in a web-site of the faculty of philosophy of the Saarland University.

4.3 Results

Means and standard deviations of jump distances by triple-hop test across the eight protocols are shown in Table 12.

Table 12: Means and standard deviations of jump distances (cm) in triple-hop test across the eight protocols.

Treatment	Baseline	Post-stretch	Post-test
	M \pm SD	M \pm SD	M \pm SD
JU	717 \pm 94	-	723 \pm 98
SQ	709 \pm 99	-	718 \pm 96
ISO	717 \pm 99	-	717 \pm 92
REST	711 \pm 97	-	714 \pm 99
SS+ JU	712 \pm 96	678 \pm 92	705 \pm 89
SS+ SQ	712 \pm 91	678 \pm 98	713 \pm 92
SS+ ISO	712 \pm 99	678 \pm 92	705 \pm 95
SS+REST	716 \pm 96	690 \pm 93	703 \pm 97

¹⁰ Tab. 5 in appendix

4.3.1 Test-retest reliability

The test-retest reliability coefficients were calculated between the pre-tests in all eight conditions. Coefficients ranged between 0.92 and 0.98 (all values were significant). There was also no significant difference between the pre-tests in all conditions¹¹.

4.3.2 Jump performance following static stretching

There was a significant decrease in jump distance following the static stretch in the four stretch protocols (SS₁+JU), (SS₂+SQ), (SS₃+ISO) and (SS₄+REST) ($p < 0.000$, ES = 0.38) immediately after stretching and before the second treatment as compared to the control condition (REST). There was no significant difference between the four stretch conditions regarding the decrement in jump distance (see figure 22).

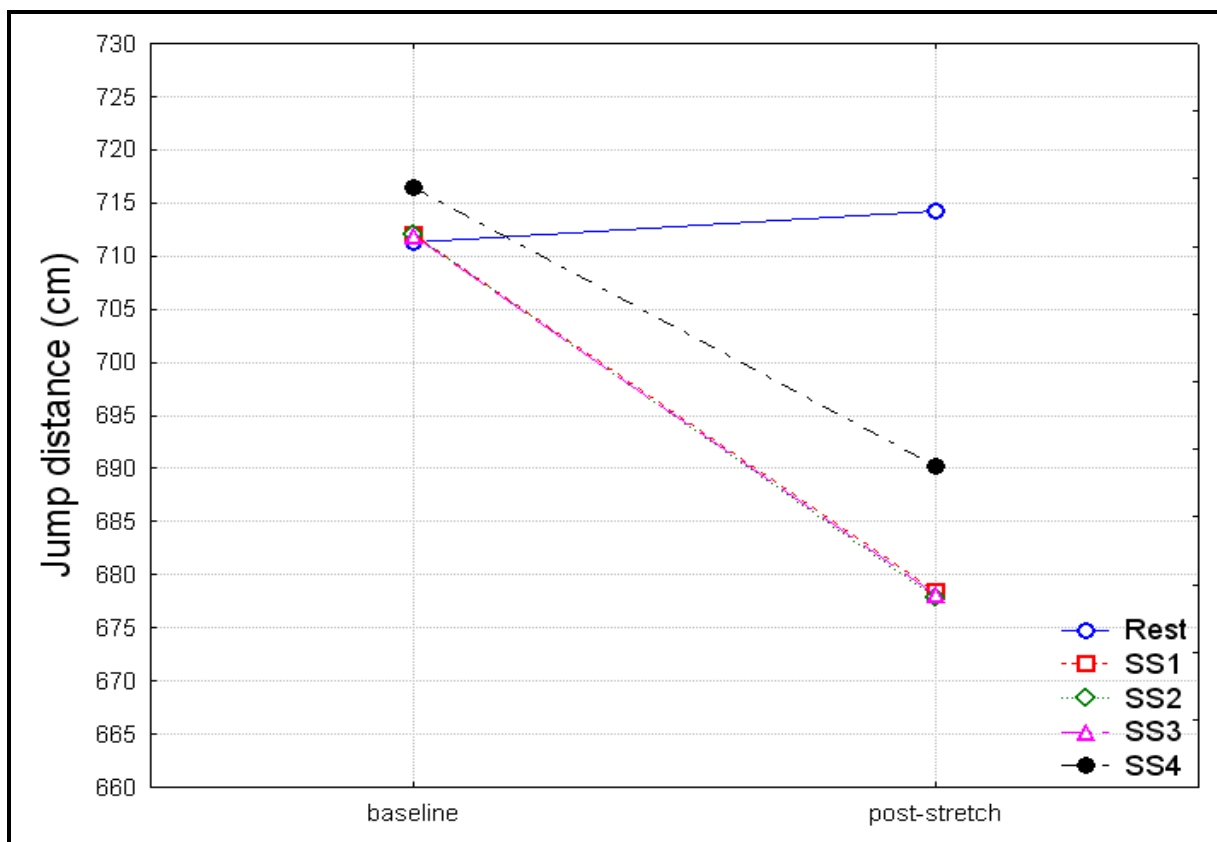

Figure 22: Effects of static stretching on triple-hop distance.

4.3.3 Restoring baseline performance

A significant difference ($F = 3.9$, $p = 0.013$) was observed between the exercises (JU), (SQ), (ISO) and (REST) (from post-test 1 to post-test 2) in restoring the jump performance after static stretching (figure 23). Post hoc contrast analysis revealed that the

¹¹ Tab. 6 in appendix

half squat exercise showed a very highly significant improvement of 5 % ($F=18.5$, $p=0.0004$, $ES=0.23$) in horizontal jump distance which was decreased following the static stretching as compared to the condition (SS+ REST), whereas the improvements in jump performance following the (JU) or (ISO) exercises by 3.7 % and 3.8 %, respectively tended to be significant ($p=0.064$ and $p=0.052$, respectively).

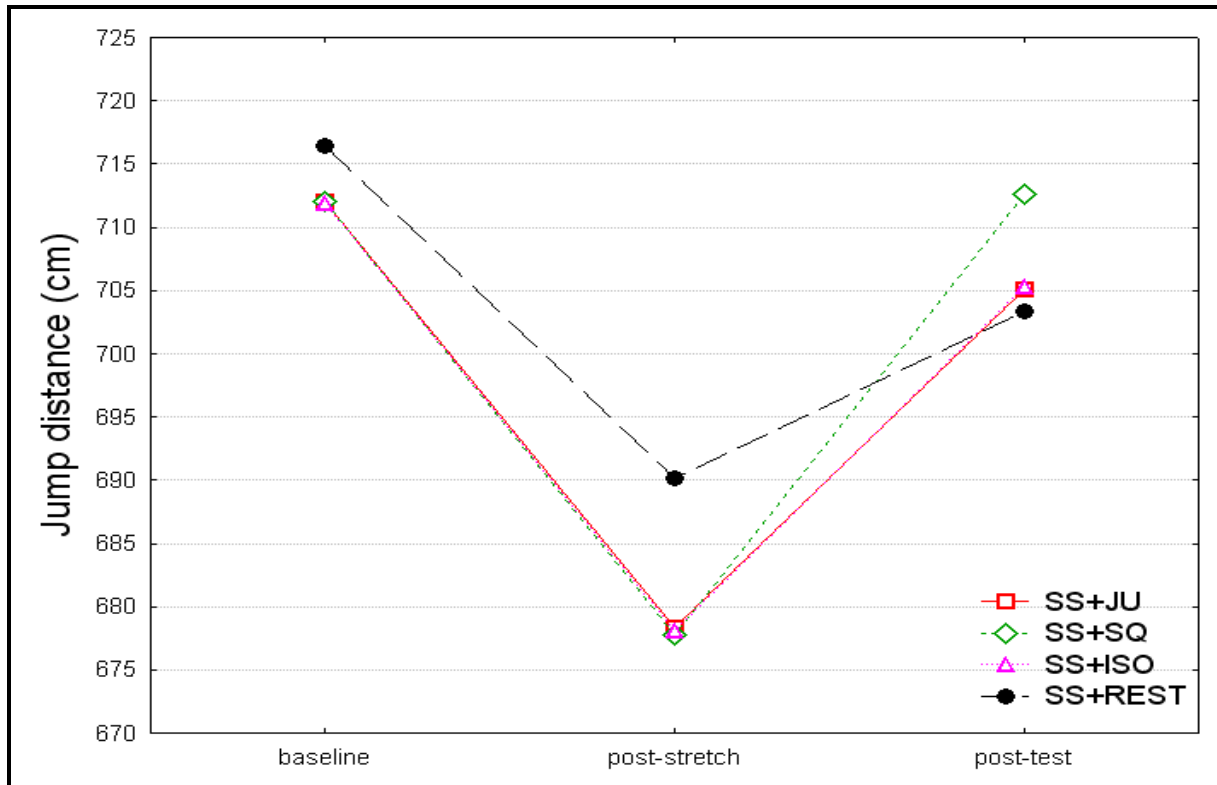

Figure 23: Effect of stretching followed by (JU), (SQ), (ISO) or (REST) on triple-hop distance.

4.3.4 Jump performance with or without static stretching

A repeated measures analysis of variance (ANOVA) analyzed the jump distances from baseline to the last achieved performance in the post test revealed a significant overall difference between the eight protocols ($F=2.4$, $p=0.024$). Contrast analysis showed the following results:

- Jump performance following (JU) was significantly better than following (SS+JU) ($F= 7.2$, $p=0.015$, $ES=0.12$).
- Jump performances following (SQ) and (ISO) were better than following (SS+SQ) and (SS+ISO), respectively, but not significantly.
- There was no significant difference between the (JU), (SQ), (ISO) and (REST) protocols.

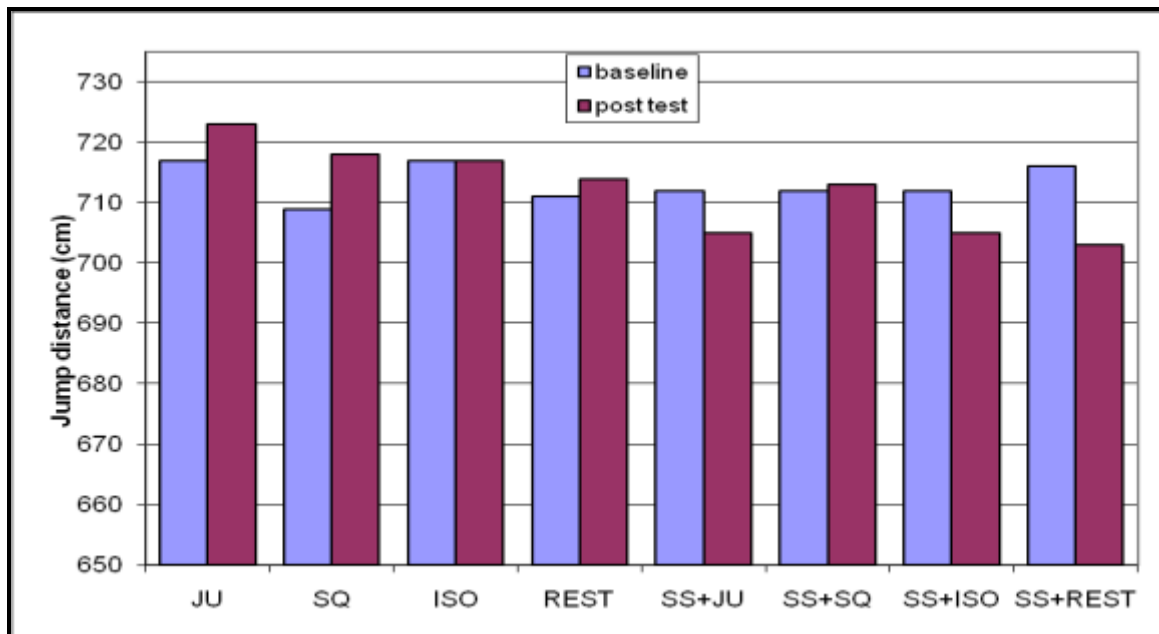

Figure 24: Effects of various exercises on triple-hop distance (from baseline to post-test)

4.4 Discussion

This experiment showed a significant decrease of the jump performance in triple-hop test in the four stretch conditions following an acute bout of static stretching (the hypothesis 1 was confirmed), in agreement with the observation of several previous studies. Reactive force production in rapid stretch shortening activities such as the drop jump performance have been frequently reported to be negatively affected by static stretching in the studies of Young et al. (2001), Young and Behm (2003), Young et al. (2006) and Hillebrecht and Niederer (2006), as well as sprint performances in the studies of Fletcher et al. (2004); Nelson et al. (2005); Fletcher and Anness (2007); Hillebrecht et al. (2007); Winchester et al. (2008); Sayers et al. (2008); Beckett et al. (2009); Chaouachi et al. (2010) and Kistler et al. (2010). Di Cagno, Baldari, Battaglia, Gallotta, Videira, Piazza and Guidetti (2010) registered that ground contact time during hopping test increased significantly after a static stretching warm-up. During a rapid stretch shortening cycle, the tendon and the crossbridges and all the series elastic elements of muscle are able to store energy during the stretch phase and use this elastic energy in the following shortening phase to produce more force. When a muscle is being stretched, the stiffness of musculotendinous unit decreases, and this causes a defeat in the amount of the storage of the elastic energy and this influences performances in the following stretch shortening activities (O'Connor et al., 2006).

The mechanisms in which static stretching affects the following performance will be extensively reviewed in the discussion of the third study. Contrariwise to the result of this study, no changes were registered in distances for broad jump, single-hop, triple-

hop, and crossover-hop and elapsed time for a 6-m timed hop in the investigation of Handrakis, Southard, Abreu, Aloisa, Doyen, Echevarria, Hwang, Samuels, Venegas and Douris (2010), whereas McMillian et al. (2006) reported an increase in 5-step-jump performance following ten-minutes static stretching.

The dynamic squat exercise with a rapid execution showed a very good ability in restoring decrements in jump performance after static stretching. However, the effect size revealed a trivial practical relevance. This enhancement in performance could be interpreted through the effect of the dynamic squat exercise in stimulating the motoneurons and inducing a postactivation potentiation, and/or in restoring the possible defeated amount of musculotendinous stiffness following stretching. The hypothesis 2 was confirmed in the dynamic squat exercise.

Squat exercise also showed a positive effect on the following jump performance in studies of Gourgoulis et al. (2003), Hoffman (2007) and Saez Saez de Villarreal et al. (2007), which was also seen as a result of the postactivation potentiation mechanisms.

The isometric squat and jump exercises could partly (insignificantly) restore the jump performance (The hypothesis 2 was denied in the isometric squat and jump exercises).

The results of Hillebrecht & Niederer (2006) indicated that six maximal isometric contractions caused more decreases in the drop jump heights, whereas the jump performance remained unchanged following ten consecutive maximal vertical jumps. Perhaps the exercise patterns or the moderate loads in this study were not enough to stimulate the motoneurons or to restore the stiffness of the musculotendinous unit.

The implication of a static stretching program in the warming-up phase seemed to be not suitable, especially if the subsequent performances require a high level of power and reactive force production with a rapid stretch shortening cycle just like the triple-hop performance. When static stretching combines with dynamic squats with moderate loads, decrements in jump performance may be compensated.

The perplexing question at this point is why to implicate the static stretching in the warm-up at all if possible performance-deficit could happen. Additionally, there is no scientific evidence that static stretching helps in reducing injuries or preventing the delayed onset muscle soreness, and that other stretching types such as dynamic stretching can increase the range of motion better than static stretching (Wydra et al., 1991; Wydra et al., 1999)

Conclusion: Static stretching influences subsequent horizontal jumping performances with fast stretch shortening cycle negatively. When athlete can not relinquish practicing static stretching, the stretch exercises must be followed by compensating procedures to restore performance-deficits. Three sets of eight dynamic half squat with light loads and explosive executions could compensate this performance-deficits.

5 Third study: Acute effects of static stretching followed by weighted jumps on vertical jump performance

5.1 Introduction

The acute effects of static stretching on vertical jump performance were frequently investigated. However, the results of these investigations are confusing. Significant reductions in vertical jump performances were reported in the studies of Behm et al. (2006), Behm and Kibele (2007), Bradley et al. (2007), Cornwell et al. (2002), Faigenbaum et al. (2005), Hillebrecht and Niedderer (2006), Holt et al. (2008), Hough et al. (2009), Pearce et al. (2009), Perrier et al. (2011), Taylor et al. (2009), Vetter (2007), Wallmann et al (2005), Wiemeyer (2003), Young and Behm (2003) and Young and Elliott (2001). Vertical jump performances with slow as well as fast stretch shortening cycles were shown to be lower following the static stretching. On the other hand, a lot of studies reported equivocal results. Vertical jump performances remained unaltered in the studies of Brandenburg et al. (2007), Burkett et al. (2005), Ce et al. (2008), Chaouachi et al. (2010), Church et al. (2001), Cornin et al. (2008), Cornwell et al. (2002), Curry et al. (2009), Dalrymple et al. (2010), Di Cagno et al. (2010), Faigenbaum et al. (2006), Gonzalez-Rave et al. (2009), Little and Williams (2006), Murphy et al. (2010), Power et al (2004), Unick et al. (2005), Robbins and Scheuermann (2008), Samuel et al. (2008) and Wallmann et al (2008). Therefore, the first aim of this study was to investigate if the vertical jump performance in countermovement jump is actually decreased immediately following the static stretching. The second purpose of the study was to investigate if these impairments could be compensated using an activation exercise. This problem was insufficiently explored in the literature. After analyzing results of investigations in which various exercises in producing potentiation and improving the following performances were studied and reviewed in table 1, and after analyzing the results of the second study as well as discussions with experts in strength and power training in Frankfurt University and Saarland University, it was suggested that weighted jumps with a light load are likely to be able to induce potentiation and thereby could restore the expected decreases in jump performance following static stretching. This study aimed to investigate if the expected acute decrement in jump performance following static stretching could be compensated through weighted jumps with a light load, and if changes may occur in muscle activity (IEMG). The following questions have to be answered:

- Is in this study jump performance negatively affected after static stretching?
- Could the weighted jumps (WJ) suit best in compensating the expected reduction of performance following static stretching?

- Which changes occur in the kinetics measures of the countermovement jump following the various treatments?
- Which changes would happen in the amplitude parameters of the muscles activity during countermovement jump following the various treatments?

5.2 Methods

5.2.1 Subjects

Thirty active sport students, men ($n = 18$) and women ($n = 12$) participated in this study. The students were physically active either for their sport study or for other fitness purposes. The descriptive characteristics are found in table 13. Each individual declared themselves free of any history of hip, knee or ankle problems and signed a written informed consent prior to testing. Subjects were recruited based on their participation in a research seminar in their sport study at the Sport Science Institute of Saarland University (Germany).

Table 13: Descriptive statistics (mean $M \pm$ standard deviation SD) for age, height and weight of the subjects ($n=30$) in the third study.

	Men ($n=18$)	Women ($n=12$)
	$M \pm SD$	$M \pm SD$
Age (year)	23 ± 2	22 ± 1
Height (cm)	181 ± 5	166 ± 4
Mass (kg)	76 ± 7	59 ± 6

5.2.2 Variables

Measurement of the one repetition maximum (1-RM)

After three separate training sessions, subjects performed at the 4th session a 1-RM Estimation test. Up to five series of sets of half-squats with increasing weight were performed until up to ten repetitions were achieved without failure. 1-RM was then predicted in the light of 1-RM estimating table¹² from Baechle, Earle and Wathen (2008). The subjects rested for at least three minutes between trials. Prior to the trials subjects performed a five minute cycling by $1.5 \times$ body mass (watt) and several warm up repetitions with a light weight.

Measurement of ground reaction forces

A 3-component (F_x , F_y , F_z) mobile Kistler force plate¹³ (type 9286B, height: 35-mm, weight: 18-kg) was used to measure ground reaction forces during the countermovement jump. The

¹² Fig. 6 in appendix

¹³ Fig. 7 in appendix

counter movement jump test is one of the most popular valid way to assess power output (Johnson & Bahamonde, 1996), and it was reported to be reliable (Stockbrugger & Haennell, 2001). The subject started from an upright standing position on the plat form, made a preliminary downward movement by flexing at the knees and hips, then immediately and vigorously extended the knees and hips again to jump vertically up off the ground (Linthorne, 2001). Force data was collected from before the start of countermovement jump to after landing to record flight time during the jump task. The jump height was calculated from the flight time. Subjects were instructed to keep the hands on the hips for the duration of the jump, to jump for maximum height and to execute a countermovement immediately before the upward phase (Gore, 2000). The time of force plate contact (TC) which was the time between start of the movement and take-off, as well as the peak force (PF) which was the maximum ground reaction force value during the movement of the countermovement jump were measured.

Measurement of the Muscle Activity (EMG)

Muscle activity or electromyography (EMG) is an experimental technique measures the process of the electrical excitation, which outspreads in the cell membrane of the muscle (Freiwald, Baumgart & Konrad, 2007). EMG “provides easy access to physiological processes that cause the muscle to generate force, produce movement and accomplish the countless functions which allow us to interact with the world around us” (De Luca, 1997, p. 135). As shown in figure 25, EMG signals are generated as following: when an end-plate potential generated at a nerve-muscle synapse, it results an action potential in muscle fiber, and this potential spreads from the synapse to the end of the fiber in both directions (Enoka, 2008). All the muscle fibers which are supplied from the same motoneuron will be stimulated to contract simultaneously if this motoneuron is activated (Sherwood, 2006). However, the activation of the motoneuron must exceed a certain threshold level to generate an action potential (Konrad, 2005).

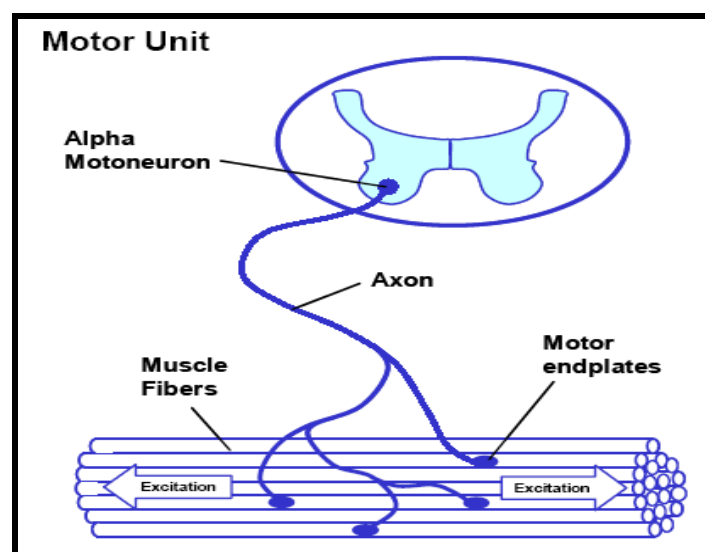

Figure 25: A motor unit of a skeletal muscle (adapted from Konrad, 2005, p. 6)

An ionic balance between the inner and outer spaces of the muscle fiber membrane which is produced through the ion pump results a resting potential. The negative intracellular charge amounts approximately -80 to -90 mV and the concentration of the Ca^{2+} ions is under 10^{-7} mol/l (figure 26). An excitation derived from the motoneuron causes a quickly change in the intracellular charge to $+30$ mV and generates an action potential (monopolar electrical burst). The Na^{+2} ions flow into the intercellular space and cause a briefly modification of the diffusion characteristics of the muscle fiber membrane. This phase is called “depolarization”. The Ca^{2+} ions begin also to flow from the terminal cisternae into the cytoplasm of the muscle fiber approximately 20 millisecond after the excitation. At the end of the depolarization phase the concentration of Ca^{+2} ions amount 5-10 mol/l. Linked chemical processes (electro-mechanical coupling) finally produce a shortening of the contractile elements of the muscle cell. The depolarization is immediately restored in the “repolarization” by backward exchange of ions within the active ion pump mechanism after a hyperpolarisation period (Freiwald et al., 2007; Konrad, 2005).

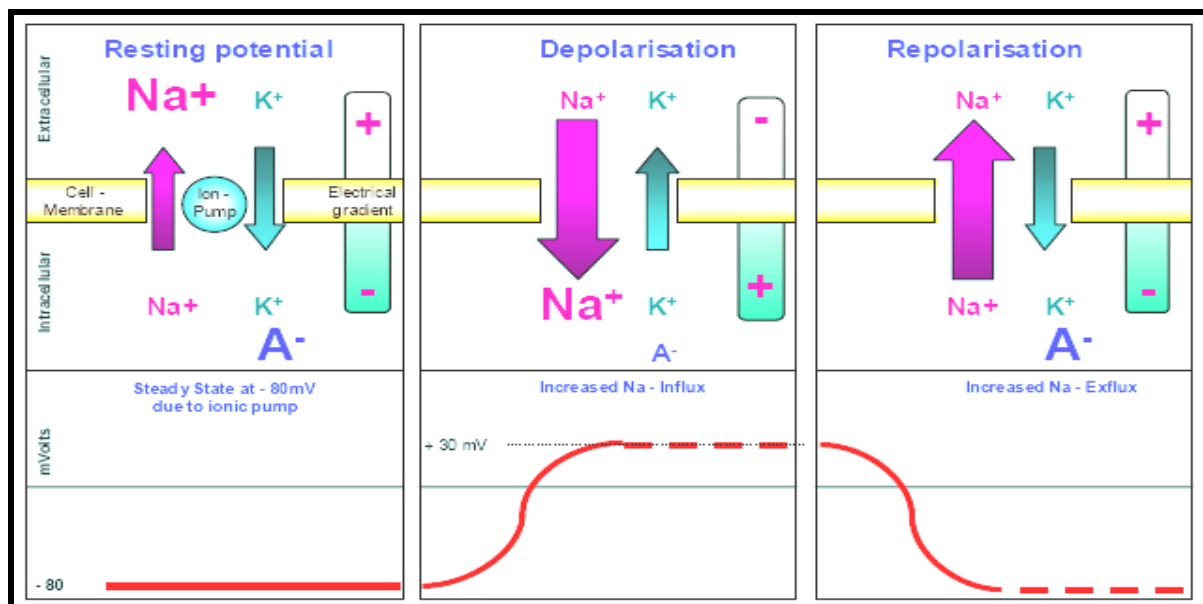

Figure 26: Schematic illustration of depolarization/ repolarization cycle (adapted from Konrad, 2005, p. 6)

The delay between the detection of the action potential and the first indication of the contractile activity is referred to as electromechanical delay. This delay occurs because of the time needed for conduction of activation in the T-tubules, release of Ca^{+2} ions into the cytoplasm, binding of Ca^{+2} to troponin, and initiation of cross-bridge cycling (Macintosh, Gardiner & McComas, 2006). The extent of the innervation zone is approximately $1\text{-}3\text{ mm}^2$, and this zone travels along the muscle fiber at a velocity of $2\text{-}6$ m/sec. Bipolar electrode are used for kinesiological electrical muscle measurements.

Depending on the distance between electrodes (a) and (b) the dipole forms a potential difference between the electrodes (Freiwald et al., 2007; Konrad, 2005).

In figure 27: at the position (1) the action potential is generated and travels towards the electrode pair, but the distance between the innervation zone and the electrode (a) still very big and thereby no muscle activity can be registered. At the position (2) is the smallest distance between the depolarization zone and the electrode (a) and thereby the highest muscle activity can be measured. At the position (3) reaches the dipole an equal distance between the electrodes and thereby no signal can be detected. At the position (4) the potential difference passes the zero line and becomes highest, which means the shortest distance to electrode (b). At the position (5) is the distance between the innervation zone and the electrode (b) very big and no signal is detected (Enoka, 2008; Freiwald et al., 2007; Konrad, 2005).

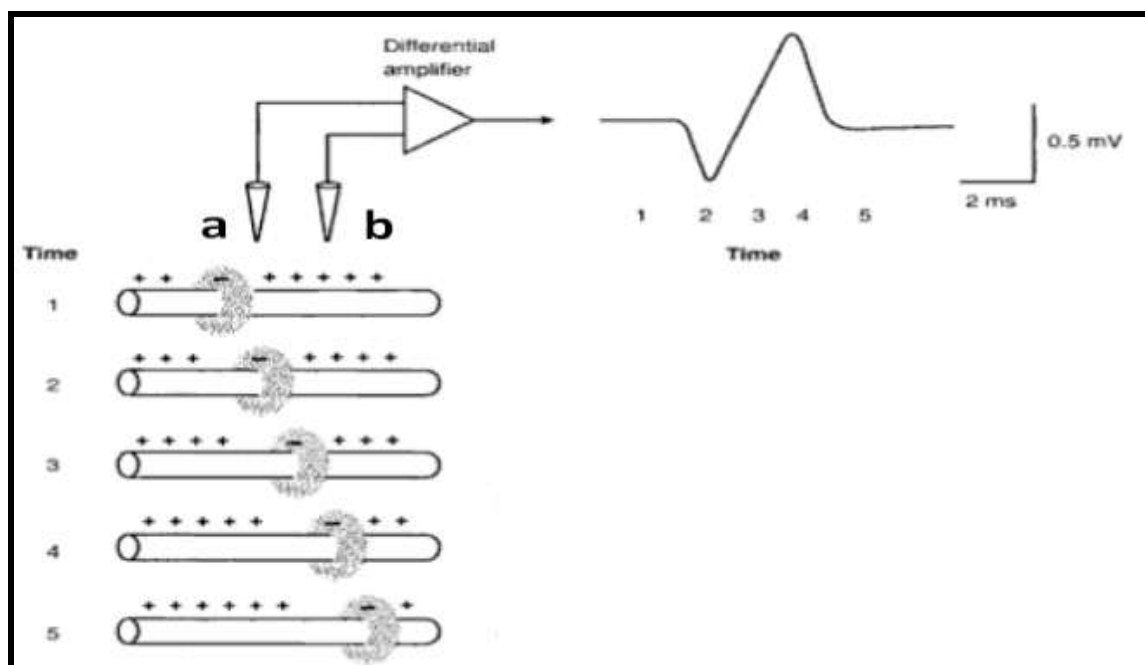

Figure 27: Propagating of an action potential along a single muscle fiber (adapted from Enoka, 2008, p. 197)

In a normal muscle contraction, all the muscle fibers within a motor unit as well as all muscle fibers of many other motor units are simultaneously activated (Freiwald et al., 2007; Konrad, 2005). The electrode pair (surface EMG) sees the magnitude of all innervated fibers within the motor unit as well as within the other activated motor units depending on their spatial distance and resolution. All these signals sum up to the motor unit action potentials which can be seen on screen of an EMG measuring unit and is called “raw-EMG-signal” (Freiwald et al., 2007; Konrad, 2005). The EMG activation is a coercive requirement for any force development. Both parameters correlate usually in a high value to each other. This means, when a muscle generates more

EMG, the forces inside and around the joint analogical increase (see figure 28). Although, this relationship could significantly vary between different contraction tasks or between various muscles (Konrad, 2005). However, just in isometric contractions the relationship can be strong and not in anisometric contractions, because that various mechanical, physiological, anatomical and electrical modifications occur throughout the anisometric contraction which affect this relationship. Furthermore, if the relationship between force and EMG is to be compared among different subjects, this relationship can be potentially affected (De Luca, 1997).

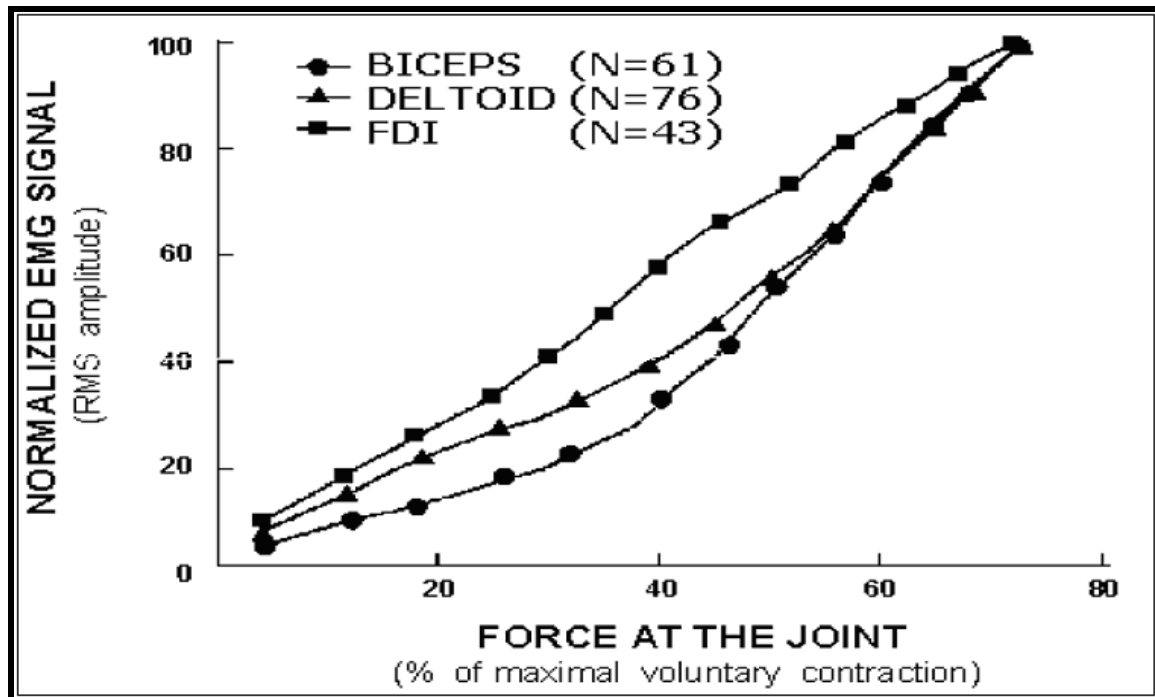

Figure 28: The relationship between EMG-input and force-output of three various muscles (adapted from De Luca, 1997, p. 151)

Data-collection

Surface EMG activity in the m. gastrocnemius medialis (GM), m. gastrocnemius lateralis (GL), m. vastus medialis (VM) and m. vastus lateralis (VL) was recorded with a sampling rate of 1000 Hz using an A/D converter (Biovision, Germany) and dual center-to-center EMG monitoring electrodes (3M, Korea) with foam tape and sticky gel with 3-cm spacing were applied in the direction of the muscle fibers on the surface of the skin to the right leg¹⁴. The preferred location of SEMG is in the midline of the belly of the muscle between the nearest innervation zone and the myotendonous junction. In this location the EMG signal with the greatest amplitude is detected (De Luca, 1997). One neutral reference electrode (ground electrode) must be also at least conducted. This electrode can be placed over an electrically unaffected area such as joints,

¹⁴ Fig. 8 in appendix

bones, forehead, tibia bone etc. (Konrad, 2005). In the present study the ground electrode was placed over the tibia. For each electrode placement location, the skin was prepared by shaving the hair, abraded with sandpaper and then wiped with alcohol before electrode attachment. The electrodes were fixed before the initial cycling warm up and remained fixed for the duration of the test and were not removed until the subjects had finished testing. The position of each electrode was marked with a permanent marker in order to apply the electrodes as much as possible at the same positions on the skin. A worksheet for data-collection was developed to synchrony record signals from the force plate and the EMG-sensors and then store signals in a DASyLab-file. Analyses of median power frequency using fast fourier transformation (FFT) were also applied to identify any inherent noise during measurements such as the noise of electricity at 50 Hz. The inherent noise are registered during recording of EMG signal as 50-60 Hz noise signal (line interference), caused from electric equipments especially in closed rooms or laboratories (Raez, Hussain & Mohd-Yasin, 2006).

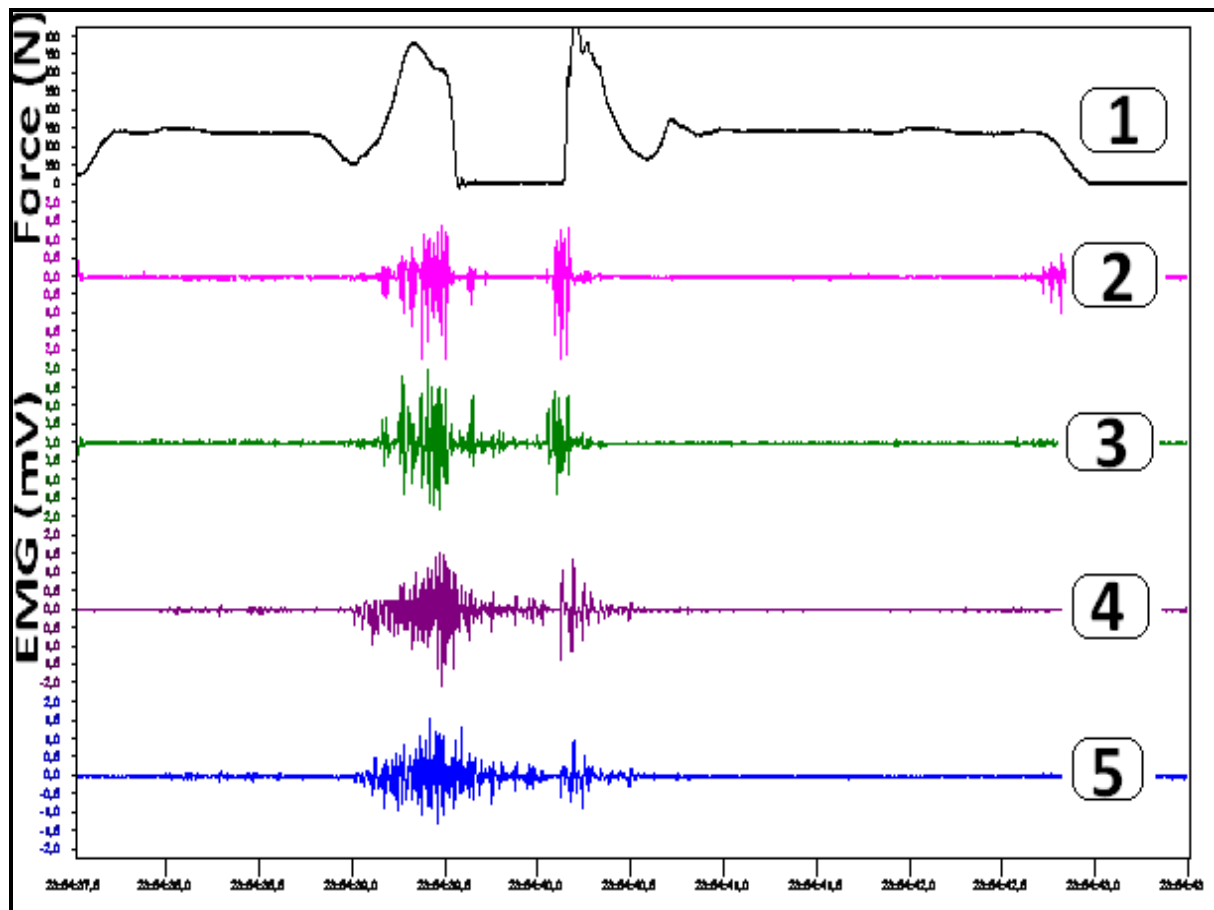

Figure 29: Raw signal recorded from a Kistler force plate and muscles activity: 1. ground reaction forces, 2. EMG of gastrocnemius medialis, 3. EMG of gastrocnemius lateralis, 4. EMG of vastus medialis, 5. EMG of vastus lateralis.

Processing of EMG-signal

After finishing the data-collection phase, the stored files (file-type: DASyLab) that were being called up in another (reading) worksheet was used to process signals and prepare data in order to calculate the values of the measured variables. The data-reading worksheet consisted of various complexes of modules¹⁵: the stored files had been called up through an entry module. A stored file contained 9 canals. The canals from (1) to (4) were the ground reaction forces of four force sensors which are placed in every corner of the force plate, and the canal (0) was the sum of them. The canals from (5) to (8) were for the signal of muscle activity in gastrocnemius medialis, gastrocnemius lateralis, vastus medialis and vastus lateralis, respectively. The upper part of the worksheet was used to calculate the jump height from the ground reaction forces in canal (0). The triggering modules in the middle of the worksheet contained various combi-triggers to cut the EMG-signals according to the TC. The raw EMG signal is the unfiltered and unprocessed bipolar EMG signal. It contains very important information and gives the first objective documentation and information of muscle's innervation. The raw EMG frequencies ranged between 5 and 500 Hz, but the main part ranged between 10 and 150 Hz (Konrad, 2005). The raw EMG-signal in this study was processed by filtering (20-400 Hz), in order to filter signals with frequencies outside the band pass and artifact-signals resulted from rapid cable movements. This filtering increases the reliability and validity of findings and is recommended from the international scientific associations (SENIAM, 2011)

Then, signal full-wave rectifying was applied. The full-wave rectification produces the absolute value of the EMG. All negative amplitudes are converted to positive amplitudes (Konrad, 2005).

The next step was calculating the integrated EMG during the contact time on the force plate (TC). A complex trigger function was used to cut the raw EMG-signal so that all the EMG-signals outside the contact phase were excluded, and just the signal during the contact phase was evaluated. Test-data for ground reaction forces and EMG were recorded and processed with Data Acquisition System Laboratory program (DASyLab, version 10).

¹⁵ Fig. 9 in appendix

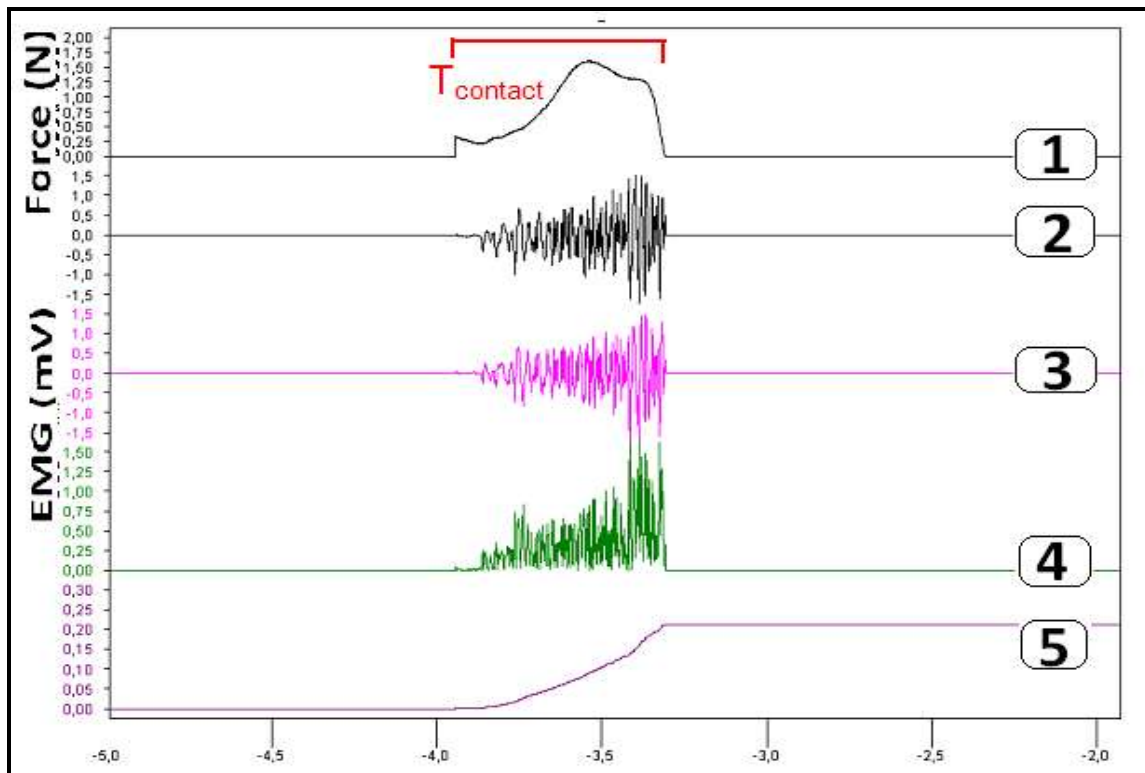

Figure 30: EMG-Signal processing: 1. Triggered ground reaction forces 2. EMG-triggering, 3. EMG-filtering, 4. EMG-full-wave rectifying 5. EMG-calculating the integrated EMG value.

5.2.3 Treatments

Experimental condition: static stretching (SS)

Subjects performed five trials of the CMJ-test prior to and immediately after four stretch exercises and once again after three sets of four weighted jumps. The stretching exercises consisted of three sets of four various static stretching exercises performed with a 20 second holding at the point of discomfort. The stretches that were chosen intended to passively exercise muscle groups strongly involved in the countermovement jump. The chosen exercises¹⁶ were:

1. Standing single leg plantar flexor stretch: in a standing position leaned forward to a wall with one straight leg and the foot sole completely kept on the ground about one meter from the wall (3 sets x 20 seconds).
2. Standing single leg quadriceps stretch: in a standing position with one flexed leg was pulled with the hand (3 sets x 20 seconds).
3. Seated single leg gastrocnemius and hamstring stretch: in a seated position the toes of one foot were pulled while the same leg kept straight (3 sets x 20 seconds).

¹⁶ Fig. 10 in appendix

4. Seated double leg straight legs toe touch: in a seated position with both legs straight, the upper body was flexed forward and the arms were straighten to reach the toes (3 sets x 20 seconds).

Experimental condition: weighted jumps (WJ)

Three sets of four loaded countermovement jumps by 30 % of 1-RM (a bar with weight was carried on the shoulders as in back squat¹⁷). The subjects were verbally encouraged to jump as high as possible, instructed to execute a countermovement at a self-selected depth, and to bend the knees upon landing to absorb the impact. There was approximately three seconds pause between the repetitions, 90 seconds rest between the sets and two minutes rest before the post-test.

Control condition

Subjects performed five trials of the CMJ-test prior to and after eight minutes rest with no activity (matched the duration of the stretching exercises), and once again after another seven minutes of rest (matched the duration of the weighted jump exercise).

5.2.4 Study design

Before starting with the jump measurements, subjects performed three separate standardized training and familiarization sessions aimed to habituate to tests and treatments procedures of the experiment to eliminate the learning effects, familiarization, and carry-over effects. Subjects were given standardized instructions as to the proper technique for half-squat, CMJ, SS and WJ exercises of the experiment and then practiced and trained all of those tests and exercises. In the 4th session subjects performed a 1-RM-estimation-test. Then, they attended a total of two data collection sessions (within-subject design) and were completed within a week, so that the two test days were at the same weekday and the same time of day. Each session started with an initial warm up period of five minute cycling by $1.5 \times$ body weight (watt), followed by the pre-test (see table 14). The order of the protocol assignment was randomized per person. All warm up exercises with subsequent data collection and testing occurred in a laboratory of the Sport Science Institute of the Saarland University (Germany).

Table 14: Procedures order in the third study

	1	2	3	4	5	6	7
Experimental condition	Electrodes fixation	5 min cycling	5 trials CMJ-test	Stretching	5 trials CMJ-test	Weighted Jump	5 trials CMJ-test
Control condition	Electrodes fixation	5 min cycling	5 trials CMJ-test	8 min rest	5 trials CMJ-test	7 min rest	5 trials CMJ-test

¹⁷ Fig. 11 in appendix

5.2.5 Hypothesis

The following hypotheses were formulated:

Hypothesis 1: The vertical jump height decreases following the static stretching exercises.

Hypothesis 2: Weighted jumps can restore the decrement in vertical jump height which was negatively affected from static stretching exercises.

Hypothesis 3: Peak ground reaction forces decrease following static stretching, and increase following weighted jumps.

Hypothesis 4: The contact time on the force plate (TC) following static stretching is longer, and is shorter following the weighted jumps.

Hypothesis 5: The muscle activity decreases following stretching, and increases following the weighted jumps.

5.2.6 Statistical analyses

In each test time merely two trials with the best jump height values were averaged and evaluated. Descriptive statistics (mean, SD) for age, height, weight, and the variables in addition to the correlation coefficients by the pre-tests in the two conditions were calculated. A Kolmogorov–Smirnov test showed that all data were normal distributed, with one exception (the IEMG of gastrocnemius lateralis in the post-test)¹⁸. Two-way factorial repeated measures analysis of variance ANOVA was used to analyze differences between criterion measures following the two protocols. When a significant p value was achieved, post hoc contrast analysis was used to identify specific differences between criterion measures or testing sessions. Statistical significance was set at $p \leq 0.05$, and all analyses were carried out using Statistica (version 10, Tulsa, Oklahoma). The Cohen's effect sizes were calculated using an effect size calculator in a website of the faculty of philosophy of the Saarland University.

5.3 Results

Means and standard deviations of jump height, contact time, peak force and IEMGs in countermovement jump test across the two protocols and the three test times are shown in table 16 and 17.

5.3.1 One repetition maximum Test (1-RM)

The results of the estimated one repetition maximum test are shown in the following table:

¹⁸ Tab. 7 in appendix

Table 15: Results of the estimated one repetition maximum test.

	Men (n=18)	Women (n=12)
	M ± SD	M ± SD
1-RM (kg)	171.7 ± 27	134 ± 18.4

5.3.2 Test-retest reliability

The test-retest reliability coefficients were calculated between the pre-tests in the two conditions and showed a high repeatability ($r = 0.92$) for the jump height. The other correlation coefficients were 0.72, 0.94, 0.86, 0.55, 0.62 and 0.27 for the contact time, peak force and the integrated EMG in GM, GL, VM and VL, respectively¹⁹.

5.3.3 Jump height

2x3 repeated measures analysis of variance ANOVA revealed a significant overall difference between the two protocols ($F=40.5$, $p=0.000$). Post hoc contrast analysis showed the following results (see figure 31):

- There was a high significant decrease in jump height in the experimental condition by 5.3 % ($F=21.5$, $p=0.000$, $ES=-0.23$) following the static stretching (immediately after stretching and before WJ) as compared to the control condition.
- There was a high significant increase (restoring of performance after stretch) in jump height in the experimental condition by 6.9 % ($F=89.1$, $p=0.000$, $ES=0.53$) following the WJ (from post-stretch to post-test), as compared to the control condition.
- The enhancement in jump performance by 1.6 % following the combination of stretching and WJ (from baseline to post-test) was found to be significant ($F=17.1$, $p=0.000$, $ES=0.23$) as compared to the control condition.

Table 16: Means ± standard deviations of jump heights (cm) in countermovement jump test across the two conditions and the three test times.

Treatment	Baseline	Post-stretch	Post-test
	M±SD	M±SD	M±SD
SS + WJ	35.9 ± 4.6	34 ± 4.5	36.5 ± 5.1
Control	35.2 ± 4.9	34.7 ± 5	34.6 ± 4.9

¹⁹ Tab. 8 in appendix

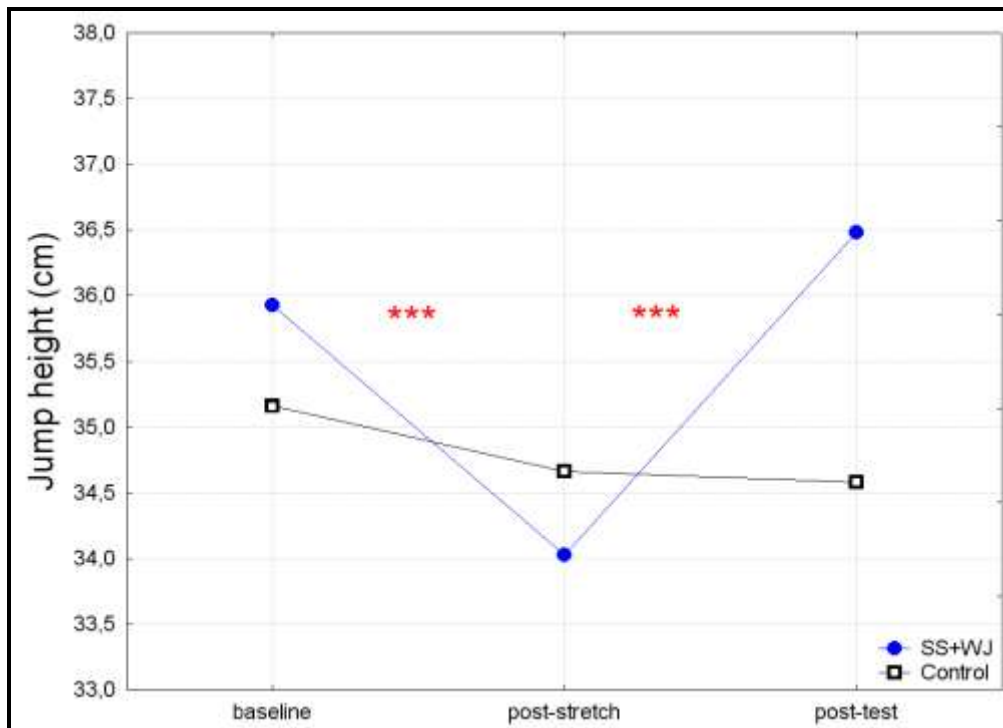

Figure 31: Effect of stretching, weighted jumps, or rest (control) on jump height. (***: $p < 0.001$)

5.3.4 Peak force and contact time

- There were no significant differences in peak force in both protocols over the three test times (figure 32).
- There was a significant overall difference in contact time (TC). Post hoc tests using contrast analysis showed that an increase in contact time occurred following the static stretching in the experimental condition by 4.5% (immediately post-stretching and before WJ), however, this increase just tended to be significant ($F=4.0$, $p=0.055$). This increase in contact time after stretching in the experimental condition was significantly compensated after the weighted jump exercise by 4.5% ($F=6.8$, $p=0.015$, $ES=-0.5$).

Table 17: Means \pm standard deviations of contact time and peak force in counter-movement jump test across the two conditions and the three test times.

Treatment	Contact time (sec)			Peak force (N)		
	Baseline	Post-stretch	Post-test	Baseline	Post-stretch	Post-test
SS+WJ	0,84 \pm 0,1	0,88 \pm 0,1	0,84 \pm 0,08	1735 \pm 311	1741 \pm 313	1751 \pm 308
Control	0,86 \pm 0,1	0,85 \pm 0,11	0,86 \pm 0,11	1738 \pm 331	1763 \pm 338	1744 \pm 327

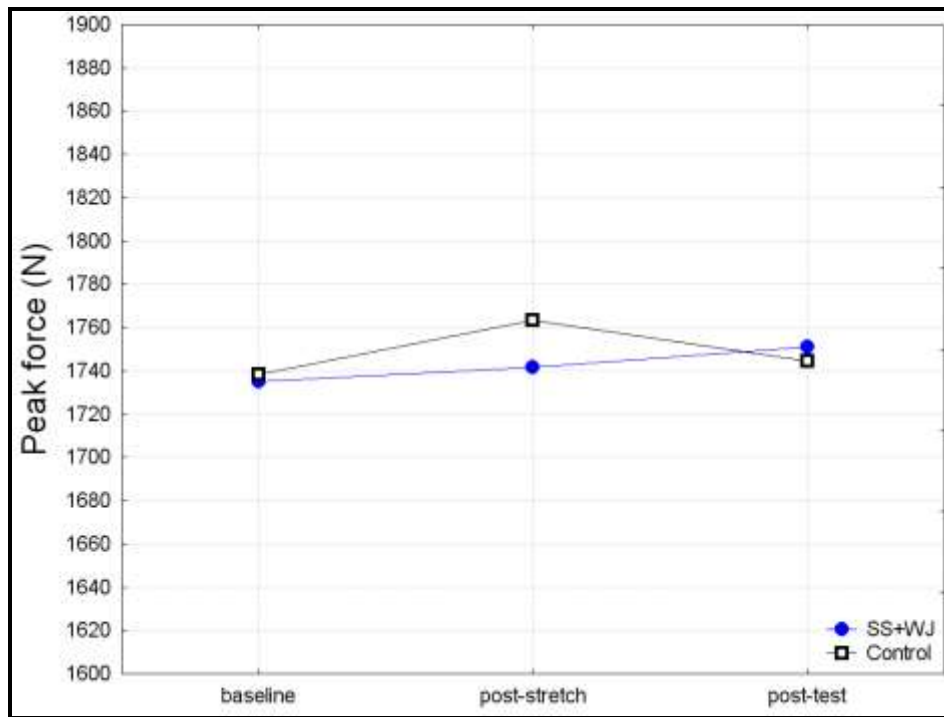

Figure 32: Effect of stretching, weighted jump, or rest (control) on peak force.

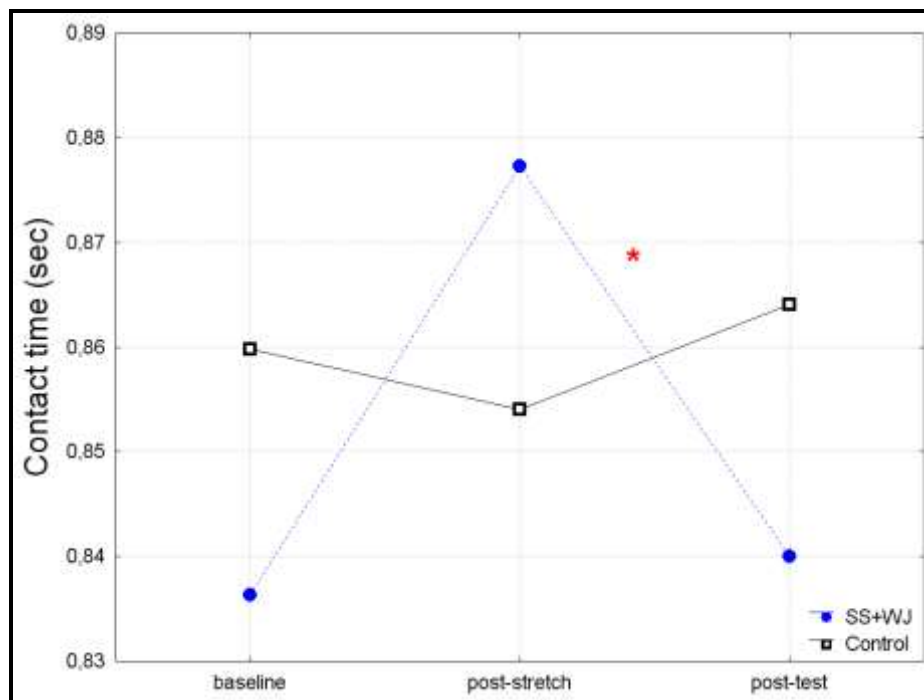

Figure 33: Effect of stretching, weighted jump, or rest (control) on contact time (*: $p < 0.05$)

5.3.5 Muscles activity

There was no significant difference in muscles activity between the two conditions across the three test times in all four muscles.

Table 18: Means \pm standard deviations of IEMG (mV*second) in the four investigated muscles during CMJ-test across the two conditions and the three test times.

Muscle	Treat.	Baseline	Post-stretch	Post-test
		M \pm SD	M \pm SD	M \pm SD
Gastrocnemius medialis	SS+WJ	0.1 \pm 0.04	0.1 \pm 0.03	0.1 \pm 0.04
	Control	0.1 \pm 0.04	0.1 \pm 0.04	0.1 \pm 0.05
Gastrocnemius lateralis	SS+WJ	0.1 \pm 0.04	0.1 \pm 0.03	0.1 \pm 0.04
	Control	0.09 \pm 0.04	0.09 \pm 0.03	0.09 \pm 0.04
Vastus medialis	SS+WJ	0.22 \pm 0.11	0.22 \pm 0.12	0,22 \pm 0.12
	Control	0.22 \pm 0.10	0.23 \pm 0.11	0.23 \pm 0.11
Vastus lateralis	SS+WJ	0.15 \pm 0.06	0.16 \pm 0.06	0.16 \pm 0.07
	Control	0.14 \pm 0.07	0.15 \pm 0.08	0.14 \pm 0.04

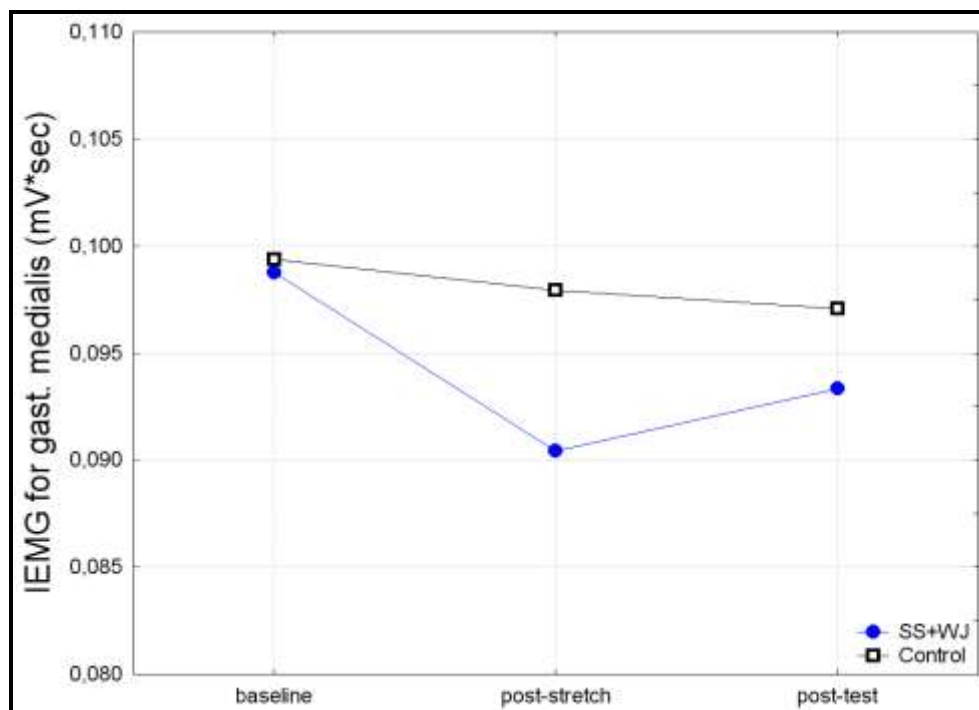

Figure 34: Effect of stretching, weighted jump, or rest (control) on muscles activity (IEMG) in m. gastrocnemius medialis.

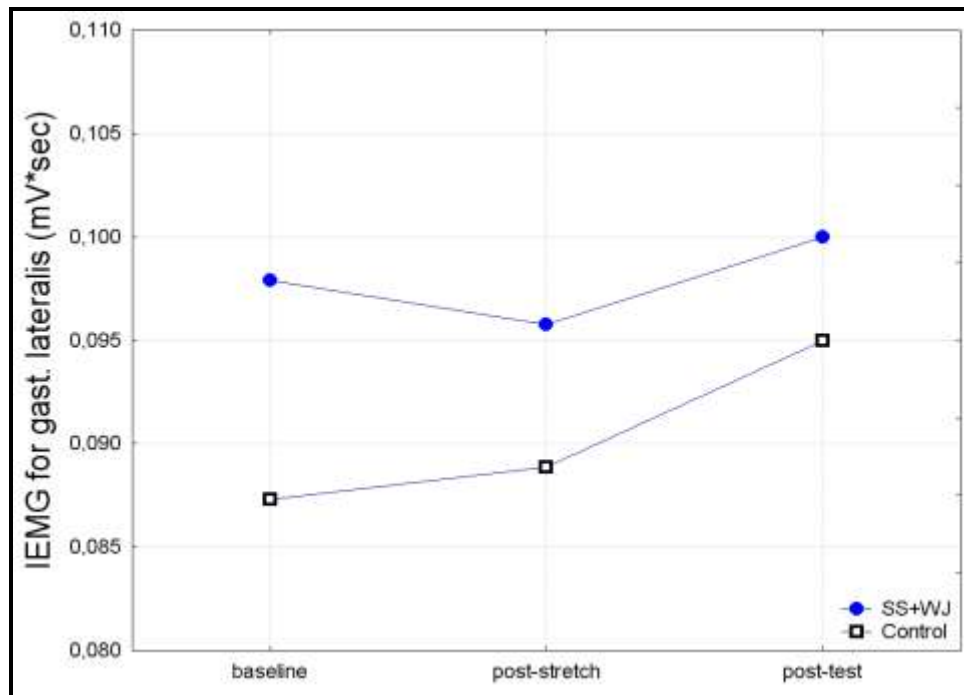

Figure 35: Effect of stretching, weighted jump, or rest (control) on muscles activity (IEMG) in *m. gastrocnemius lateralis*.

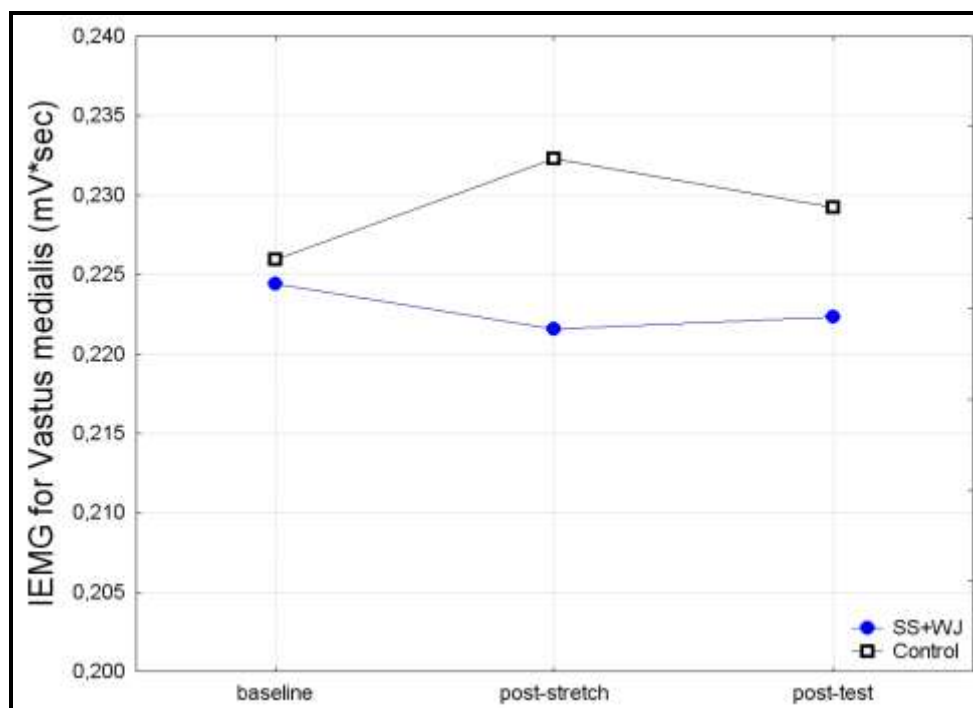

Figure 36: Effect of stretching, weighted jump, or rest (control) on muscles activity (IEMG) in *m. vastus medialis*.

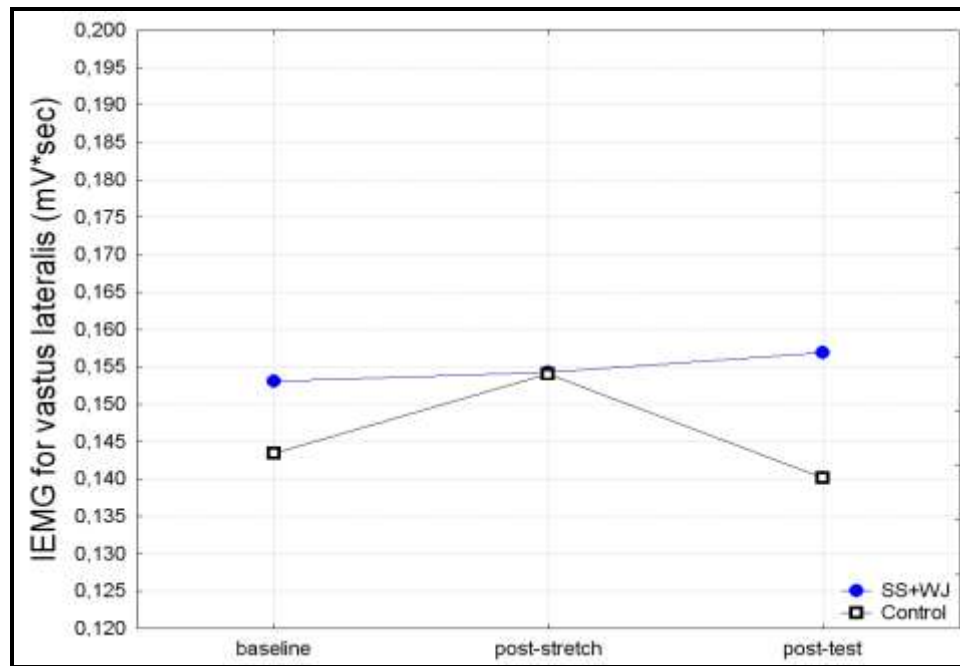

Figure 37: Effect of stretching, weighted jump, or rest (control) on muscles activity (IEMG) in *m. vastus lateralis*.

5.4 Discussion

The present study aimed to address the question regarding the effect of static stretching followed by weighted jumps on vertical jump performance and muscle activities.

Vertical jump performance in the countermovement jump decreased significantly in this study after static stretching (The hypothesis 1 was confirmed), in agreement with the observation of several previous studies (Behm et al. 2006, Behm and Kibele; 2007; Bradley et al., 2007; Cornwell et al., 2002; Faigenbaum et al., 2005; Hillebrecht and Niedderer, 2006; Holt et al., 2008; Hough et al., 2009; Pearce et al., 2009; Perrier et al., 2011; Taylor et al., 2009; Vetter, 2007; Wallmann et al., 2005; Wiemeyer, 2003; Young and Behm, 2003; Young & Elliott, 2001). However, the effect size was trivial. Duration and volume of muscle stretch in this study (three sets of 20 seconds holding the stretch) was almost a little more than durations and volumes which are used in the practical field by athletes. The mechanisms in which static stretching affects performance are not completely clear. A possible theoretical explanation related mostly to mechanical factors as well as to neural factors (Cramer et al., 2007a).

The mechanical factors are related to alternations in the biomechanical properties of tendons and muscles (Freiwald, 2009), as well as plastic deformation of connective tissue (Behm et al., 2006). Rubini et al. (2007) reported that the increase in muscular compliance following stretching so that muscle exerts less resistance to passive stretching and increases its capability of distending might be one of the possible mechanisms responsible for the decrement in performance after stretching. This phenome-

non is called “stress relaxation”, which is a reduction in tension that occurs when the muscle is stretched with a constant length. Changes in musculotendinous unit stiffness may influence the transmission of forces, the rate of force transmission and the rate at which changes in muscle length or tension are detected (Behm et al. 2005). Some studies reported that when a muscle is being stretched, the stiffness of musculotendinous unit is being decreased. Fowles et al. (2000) registered a reduction in muscle stiffness by 27 % immediately following 30 minutes maximally tolerated passive static stretching. Then, the stiffness was partly recovered quickly to 14 % at 15 minutes post-stretching, but did not completely recover within one hour. Cornwell et al. (2002) reported a significant decrement in the active stiffness of the triceps surae (muscle-tendon) following static stretching. A countermovement jump is an example of a movement that benefits from the stretch-shortening cycle (Linthorne, 2001). It is normally used to assess leg power under a slow stretch-shortening cycle and low stress load conditions (Quagliarella, Sasanelli, Belgiovine, Moretti & Moretti, 2010). During the stretch phase, the tendon-muscle complex including the crossbridges and all the series elastic elements of muscle are able to store elastic energy, and to use a portion of this stored energy in the following shortening phase to produce more force and induce performance potentiation (Komi, 2000). The reduction in the stiffness of musculotendinous unit following static stretching causes a defeat in the amount of the storage of the elastic energy and the ability to transfer this energy, and this influences performance in the following stretch-shortening activities (Fletcher & Anness, 2007; Freiwald, 2009). A further possible change might occur in the biomechanical properties of the muscle is the elongation of the muscle after stretching which alters the optimal crossbridges overlap (less amount of actin-myosin overlap), which affect the length-tension relationship for the sarcomere and could diminish muscle force output (Behm et al., 2006). Fowles et al. (2000) observed an increase in muscle belly length using B-mode ultrasound measures fascicle lengths following prolonged passive stretching of plantarflexors in a single subject. The fascicle elongation was 8, 8 and 2 mm for the m. soleus, m. gastrocnemius lateralis and m. gastrocnemius lateralis, respectively. The electromechanical delay could also be increased following static stretching because of a slacker parallel and series elastic component by slowing the period between myofilaments crossbridges kinetics and the exertion of tension by the musculotendinous unit on the skeletal system (Behm et al., 2006). Bojsen-Moller, Magnusson, Rasmussen, Kjaer & Aagaard (2005) registered a positive correlation between connective tissue stiffness and rapid muscle force exertion characteristics, muscular power and the velocity of the countermovement during maximal jumping.

Changes in the contact time on the force plate during the countermovement jump may indirectly reflect if changes in the musculotendinous properties. In the current study, the tendency to a longer contact time on the force plate during the countermovement jump following static stretching and a shorter contact time following the weighted jumps (the hypothesis 4 was confirmed following the weighted jumps) might be at-

tributed to changes in the biomechanical factors. Di Cagno et al., (2010) registered longer ground contact times during hopping test following static stretching.

The neural factors which affect performance following static stretching are related to the decrement in muscle activation. In several studies the decrement in performance was associated with a reduction in activity in the stretched muscles (Avela et al., 1999; Babault et al., 2010; Fowles et al., 2000; Cramer et al., 2005; Cramer et al., 2007a; Marek et al., 2005; Sekir et al., 2010; Young & Behm 2003). In the current study, the integrated EMG remained unchanged following static stretching in the four investigated muscles (the hypothesis 5 was denied). The same findings were also registered in the studies of Cornwell et al., 2002; Evetovich et al., 2003; Power et al., 2004; Herda et al., 2008; Ryan et al., 2008 and Hough et al., 2009, in which there were merely decreases in performance but no changes in the electrical activity. Thus, reductions in performance after static stretching in the current study could not be attributed to the decrement of the muscle activity. Further possible neural explanation of performance-deficit may be the decrement in the reflex sensitivity. Freiwald (2009) reported that static stretching has a psycho-physiologic relaxation effect through the inhibition of Hoffmann-reflex. Hoffmann-reflex is a “monosynaptic reflex induced by an electrical stimulation of group Ia afferents of the muscle nerve” (Hodgson et al., 2005, p. 587). It provides a measurement of motoneuronal excitability and of the synaptic transmission capacity from the Ia afferents to the motoneurons (Guissard & Duchateau, 2004). An inhibition in the reflex activity and a reduced spinal reflex excitability are expected in a stretched muscle. This inhibition can be registered by recording the tendon reflex (T-reflex) the Hoffmann reflex by means of electromyography in a muscle such as m. soleus (Guissard & Duchateau, 2006). In the study of Avela et al. (1999) the decrement in maximal voluntary contraction by 23.2 % was associated with a clear immediate reduction in the reflex sensitivity. Stretch reflex peak-to-peak amplitude decreased by 84.4 % and the ratio of the electrically induced maximal Hoffmann reflex to the maximal mass compound action potential decreased by 43.8 %. No measurement of reflex sensitivity were applied in the present study. Therefore, it was not possible to identify any alternations which happened in the reflex sensitivity following static stretching.

The weighted jumps could restore the baseline performance which was affected after performing the static stretching exercises (The hypothesis 2 was confirmed). This improvement in jump height by 6.9 % was also not associated with any changes of the muscles activity in the investigated muscles (the hypothesis 5 was denied). The effect size of performance-enhancement following the weighted jump exercise by 0.53 can be interpreted as trivial or small effect. This is because of the improvements in performance that occurred following a temporary reductions following stretching. Effect sizes should be interpreted dynamically and specified for individual research disciplines or domains (Fröhlich, Emrich, Pieter & Stark, 2009; Fröhlich & Pieter, 2009). Performance-deficits due to static stretching could also restored in the study of Taylor et al. (2009) following a netball specific exercises, and in the study of Hillebrecht and Nie-

derer (2006) following 3x40-m maximal sprints. Improvement in performance following the weighted jumps could also be considered as a result of the postactivation potentiation. Enhancement in performance were also registered following weighted jumps into a box (five repetitions with 10 % of body weight) in the study of Burkett et al. (2005) and the weighted jumps (three sets of five repetitions with optimal load for maximal power output) in the study of Saez Saez de Villarreal et al. (2007).

Postactivation potentiation activities could also enhance the Hoffmann reflex, thus increasing the efficiency and rate of the nerve impulses to the muscle (Hodgson et al. 2005, Parry et al. 2008). This increase in Hoffmann reflex causes greater neural activation in a following muscular activity (Parry et al. 2008). In the current study, the possible decrease in Hoffmann reflex following static stretching may was compensated according the mechanism of postactivation potentiation following the weighted jumps. Postactivation potentiation can also enhance performance by increasing the phosphorylation of myosin regulatory light chains, which increases the ionized calcium (Ca^{+2}) sensitivity of the myofilaments and thereby enhances the force of the twitch (Sale, 2004; Baudry & Duchateau, 2004; Hodgson et al., 2005; Parry et al., 2008).

The recovery time after the weighted jumps in this study was two minutes. It seems that this recovery time was enough for the muscle to recover from fatigue and still potentiated, which is recommended for an optimal recovery time to induce postactivation potentiation (Hodgson et al. 2005; Parry et al. 2008).

There were no significant differences in peak force in both protocols and over the three test times (The hypothesis 3 was denied). Possible alternation in peak force should reflect changes in the kinetic measures brought about by static stretching or weighted jumps during the countermovement jump.

The novel finding from this study was that the decreased performance due static stretching can be compensated using a suitable procedure such as weighted jumps with a light load (30 % of 1-RM). Even more, the combination of static stretching exercises followed by weighted jumps resulted overall in a significant improvement in the jump height by 1.6 %.

For some athletes a warm-up program without stretching is not thinkable. Practical experiences show that 80 % of athletes implicate stretch exercises in training, before or during competition (Schneider et al., 2011). Possible explanations for this behaviour might be that some athletes do not yet know about these negative effects of static stretching on the following performance. 74 % of the questioned athletes in a study of Schneider et al. 2011 declared that they were not provided with sufficient information or recommendations to the latest knowledge of the sport science. Some athletes already know about this phenomenon but they did not believe it yet. 55% of the questioned athletes practice stretching in training and competition although they have a negative opinion about stretching (Schneider et al., 2011). Some athletes still think that they can achieve a greater joints range of motion or prevent themselves from injuries merely through static stretching exercises. It is suggested for these athletes to

practice an activation exercise such as weighted jumps following the static stretching in order to compensate possible stretching-related decreases in performance.

Nevertheless, according to the findings of the current study as well as the results of many investigations in which static stretching-related deficits in performance were registered, it makes no sense that an athlete employs static stretching in his warm-up program when possible negative consequences may be resulted, because static stretching inhibits (mostly) an athlete's full muscular power potential (Pearce et al., 2009). As it was shown in the theoretical part of this study, there is no scientific evidence that supports the belief that static stretching may help in reducing the muscle and tendon-related injuries, or reducing the delayed onset muscle soreness.

Alternatively is to static stretching, athletic can perform dynamic stretches in the warm-up. Dynamic stretching offers a very good potency and can be optimally employed in the warm-up in order to enhance the joints range of motion without affecting subsequent performance. This is because that dynamic stretching includes both classical stretching and components of warming-up at the same time (Shrier, 2007). Even more, dynamic stretching could sometimes improve the range of motion better than the static stretching (Klee and Wiemann, 2004a). Additionally, a lot of studies revealed that dynamic stretching can enhance following performances in contrast to static stretching (Faigenbaum et al., 2010; Fletcher & Anness, 2004; Hough et al., 2009; Little & Williams, 2006; Manoel et al., 2008; McMillian et al., 2006; Sekir et al., 2010; Yamaguchi & Ishii, 2005). It is supposed that during dynamic stretching muscles are required to contract, this leads to other possible mechanisms include central programming of muscle contraction/coordination and decreased fatigue through increased warm-up activity (Shrier, 2007). These were the reasons why many top athletes and trainers disclaimed static stretching and replaced it with dynamic stretching (Kovacs, 2010).

The different results of various studies investigated the effects of static stretching may also reflect that subjects may have individual responses to an intervention of static stretching. Therefore, trainer and athletes must try to test their performance and compare if any deficits occur when applying stretches just like they typically practice in their warm-up program. The conflicting results of various studies investigated the acute effects of static stretching may be related to some unknown or unintended differences in stretching intensities between protocols (Cramer et al., 2005). The problematic of determination the intensity of a stretch is that subjective feeling of the subjects were used to determine the stretch intensity. The duration of holding the stretch may also influence the results. In the study of Siatras et al. (2008), stretching-induced reduction in performance was only observed following a static stretching exercise with 30 and 60 seconds holding the stretch, whereas no changes occurred with stretching durations of 10 and 20 seconds.

Finally, both the results of the current study and results of previous studies, in which static stretching affects performance negatively, seem to be conflictive. Pearce et al

(2009, p. 182) described that such “findings (...) should not be confused with flexibility per se” concerning the avoiding of static stretching in the warming-up before athletic activities and the implication of static stretching in a flexibility training program in order to improve joint’s range of motion. Flexibility is a very important component for execution of various movements in a good quality and quantity (Friedrich, 2007).

Conclusions: Static stretching may affect the vertical jump performance; however, this stretching-related deficit of performance could be completely compensated when weighted jumps with a light load (30 % of 1-RM) are performed a few minutes before the competition. The changes in jump performance following the static stretching or following the weighted jumps cannot be attributed to the changes in the muscle activity.

6 Summary and future perspectives

The purpose of the dissertation was to investigate the acute effects of stretching on various athletic performances, and how to quickly compensate the expected stretching-related performance-deficits following static stretching. A number of recent studies researched the acute effects of static stretching on athletic performance were reviewed and analyzed in the theoretical part of the dissertation. The reviewed studies were divided into two groups: studies which reported negative effects (49 studies), and studies which reported equivocal effects (39 studies). The practical part of the dissertation consists of three studies with 67 participants (sport students at the Saarland University). A repeated measures within-subject design was applied in the three studies.

6.1 First study

Purpose: This study aimed to investigate the acute effects of hamstring static and dynamic stretching on peak isokinetic concentric torque at a low velocity (60 °/second), the knee angle, at which this peak torque occur, and the hip flexion range of motion.

Methods: Seventeen sport students (men $n=12$, women $n=5$) participated in this study. Measurement of concentric isokinetic knee flexion peak torque including the angle at peak torque, as well as the hip flexion range of motion were performed before and immediately following four conditions. Subjects attended a total of four testing sessions (A, B, C and D) so that the order of the conditions assignment was randomized per person (within-subject design). The four conditions were: (A) hamstring static stretching (three sets of four stretches with 30 seconds holding the stretch). (B) hamstring dynamic stretching (three sets of four stretches with 12-14 repetitions). Condition (C) and (D) consisted of ten minutes passive sitting and were set as control conditions. The difference between (C) and (D) was that in (C) both force and flexibility tests were performed, whereas in (D) merely the isokinetic test was performed.

Results: Repeated measures analyses of variance showed no significant differences between the four protocols regarding the peak torque and the angle at peak torque ($p=0.474$, $F= 0.85$) and ($p=0.59$, $F= 0.63$), respectively. On the other hand, hamstring static and dynamic stretching resulted a significantly greater hip flexion range of motion ($p=0.009$, $F=8.6$, $ES= 0.37$) and ($p=0.000$, $F=33.7$, $ES=0.55$), respectively, when compared to the control condition (C). There was no significant deference between static and dynamic stretching in enhancing the range of motion.

Conclusion: Hamstring static and dynamic stretching enhanced the hip flexion range of motion with neither impairment nor facilitation in isokinetic concentric knee flexion force at low velocity.

6.2 Second study

Purpose: The aim of the second investigation was to find out which procedure - with or without a prior stretch- would best suit in warm-up program to prepare the athlete for the following training or competition, and which procedure would best suit in restoring the expected reduction of performance following a stretch.

Methods: Twenty sport students (men $n=12$, women $n=8$) performed triple-hop test on eight separate days before and after completing eight different warm-up protocols in a randomized order. The eight warm-up protocols were: a. 3x10 consecutive maximum vertical jumps (JU), b. 3x8 dynamic half-squats (SQ) with 50% of body weight, c. 3x10 seconds isometric-squats (ISO) by knee angle 120° with 50% of body weight, d. 3 minutes rest with no activity (REST), e. 2 sets of 4 passive static stretching exercises (SS) with a 30 seconds hold followed by 3x10 maximum vertical jumps (SS+JU), f. (SS + SQ), g. (SS + ISO), h. (SS + REST). In the last four conditions the triple-hop test was performed before and immediately after stretching and once again after the second treatment.

Results: Jump performance following (JU) was significantly better than following SS+JU ($F= 7.2$, $p=0.015$, $ES=0.12$), and following (SQ) and (ISO) were better than following (SS+SQ) and (SS+ISO), respectively, but not significantly. There was no significant difference between the (JU), (SQ), (ISO) and (REST) protocols. There was no significant difference between the (SS+JU), (SS+SQ), (SS+ISO) and (SS+REST) protocols. The half squat exercise showed significant improvements of 5 % ($F=18.5$, $p=0.0004$, $ES=0.23$) in horizontal jump distance which was decreased following static stretching as compared to the condition SS+REST, whereas the improvements in jump performance following the (JU) or (ISO) exercises by 3.7 % and 3.8 %, respectively tended to be significant ($p=0.064$ and $p=0.052$).

Conclusion: The implication of a static stretching program in the warming-up phase seemed to be not suitable, especially if the subsequent performances require a high level of power and reactive force production with a rapid stretch shortening cycle. When static stretching combines with dynamic squats with moderate loads, decrements in jump performance may be compensated.

6.3 Third study

Purpose: The third investigation aimed to examine if the expected decrement in jump performance following static stretching could be compensated using weighted jumps with a light load, and if changes may occur in muscles activity (IEMG).

Methods: 30 sport students (men $n=18$, women $n=12$) performed in two separate days countermovement jumps prior to static stretching, immediately after static stretching, and once again after weighted jumps (experimental condition), or before and after resting times which matched the duration of static stretching and weighted jumps (control

condition). Jump height, time of force plate contact, peak force and muscle activity of four muscles were measured during the countermovement jump.

Results: Jump height was significantly decreased by 5.3 % ($p=0.000$) following static stretching (immediately after stretching and before the weighted jumps). There was a significant increase ($p=0.000$) in jump height by 6.9 % following weighted jumps (performance decrement was significantly overcompensated). There were no significant changes in muscles activities between the two conditions across the three test times in all four muscles.

Conclusion: The decreased performance due to static stretching can be compensated using a suitable procedure such as weighted jumps with a light load (30 % of 1-RM). Even more, the combination of static stretching exercises followed by weighted jumps resulted overall in a significant improvement in the jump height by 1.6 %.

6.4 Conclusions of the dissertation

The major findings of the study can be concluded in the following head-points:

- Hamstring static and dynamic stretching enhanced the hip flexion range of motion with neither impairment nor facilitation in isokinetic concentric knee flexion force at slow velocity.
- Static stretching of lower extremities influences subsequent horizontal and vertical jumping performances with fast and slow stretch shortening cycle (in triple-hop and countermovement jump) negatively.
- Muscle activities remained unchanged in the stretched muscles (in the third study). Thus, reductions in performance after static stretching in the current study could not be attributed to the decrement of the muscle activity as some authors reported.
- The mechanisms in which static stretching affects the jump performance were possibly due to changes in musculotendinous unit properties.
- When athlete can not relinquish practicing static stretching, the stretch exercises must be followed by compensating procedures to restore performance-deficits.
- Three sets of eight dynamic half squat or three sets of four weighted jumps with light loads and explosive executions could compensate these performance deficits.
- The mechanisms in which the dynamic half squat or the weighted jumps improve subsequent performance were mostly due to postactivation potentiation and may also be attributed to the restoring of altered properties of musculotendinous unit following static stretching.
- The implication of static stretching in the warm-up must only be performed when followed with a suitable compensatorical procedure just like weighted jumps or dynamic half squat.

- Dynamic stretching would better suit than static stretching to be integrated in the warm-up as many previous investigations have suggested.
- Finally, in athletes' every day sport life individual decisions are the consequences.

6.5 Critical points in the study

In the present study, it was attempted to accomplish the various tests and treatments in standard and optimal conditions. Nevertheless, there were some critic points that should be avoided in further studies. The weaknesses in the present study can be summarized in the following points:

- The subjects recruited in the studies were sport students. Although the most of them were active in their specific training in various types of sport and some of them in high levels, the sport students are not representative for the elite athletes, who are more addressed in the results of this study. Therefore, further studies have to be investigated in elite athletes, especially in sports in which power and reactive force production of the lower extremity have a major role.
- The durations of applying the stretching in the studies of the dissertation did not match durations of stretching which are typically applied in the practical fields by elite athletes.
- All the investigated muscles using the technology of electromyography in the third study were agonists for the countermovement jump movement. However, the applied static stretching exercises includes stretches for other antagonists such as the hamstring. Changes that occurred in the muscle activity of the antagonists have to be studied.
- The distance between electrodes was 30 millimeter. However, the recommended distance between electrodes is 20 millimeter (SENIAM: the European recommendations for surface electromyography) or up to 25 millimeter (Rief & Birbaumer, 2006).
- In the third study, a further control condition was needed to be implicated to the study design in which subjects practice five jumps (pretest) followed by the static stretching exercises, five jumps (post-stretch) and then subjects rest for a similar duration as the weighted jumps. This would help in comparing the effects of weighted jumps following static stretching with the control condition.
- It was not possible in the design applied in the current study to deactivate the effects of the five jumps in the post-stretch-test. In other words, there was a convened effect of the five jumps in the post-stretch-test and the weighted jumps.
- An equation was used in the third study to predict 1-RM performance of the half squat. The accuracy of estimated equations for 1-RM can be seriously questioned, because it has been shown that they sometimes underestimate or overestimate the real 1-RM in certain populations. This inaccuracy may result from differences in

the neuromuscular and metabolic demands associated with low, moderate and high repetitions maximum (Maud, 2006).

- No specific instructions were given regarding the depth and the speed of the counter-movement jump in the third study. This may influenced the results (Gore, 2000).

6.6 Future perspectives

Further studies using this design have to research the effects of short durations of static stretching in which joint's range of motion can be enhanced without resulting performance deficits. Additionally, further studies have to investigate in elite athletes the acute effect of various specific exercises as well as static stretches which are usually implicated in their warm-ups. Which effect could have shorter durations of static stretching must be investigated in further studies.

Measurements of reflex sensitivities, musculotendinous stiffness analyses, the neuromuscular activation of the antagonist muscles, video analyses should be also integrated in the measurements in order to understand the underlying mechanisms in which static stretching affect performance.

The ability of various activation exercises in compensating impairment in performance following static stretching should be examined, especially the warm-up exercises which are frequently performed in high-level athletic trainings and competitions. A modified study-design includes a static stretching program combined with an activation exercise without the implication of a post-stretch test have to be applied in subsequent studies in order to avoid the effects of the test self on the following performance.

The results of many studies investigated the acute effects of dynamic stretching showed improvements in performance in most of cases. Dynamic stretching compared to static stretching was insufficient investigated. The huge variety in intensities, durations, volumes, rest durations and forms of exercises which can be used in the warm-up show that still many unsolved problems and questions have to be answered in subsequent investigations.

References

- Albrecht, K. & Meyer, S. (2005). *Stretching und Beweglichkeit : das neue Expertenhandbuch ; mit 120 Übungen*. Stuttgart: Haug.
- Alpkaya, U. & Koceja, D. (2007). The effects of acute static stretching on reaction time and force. *The Journal of Sports Medicine and Physical Fitness*, 47(2), 147-150.
- Alter, M. J. (1998). *Sport stretch* (2. ed.). Champaign, IL u.a.: Human Kinetics.
- Alter, M. J. (2004). *Science of flexibility* (3. ed.). Champaign, Ill: Human Kinetics.
- Anderson, B. (1980). *Stretching*. Bolinas Calif, New York: Shelter.
- Apfel, R. (2002). *Auf- und Abwärmen ... aber richtig!* (2. ed.). Donauwörth: Auer.
- Avela, J., Kyrolainen, H. & Komi, P. V. (1999). Altered reflex sensitivity after repeated and prolonged passive muscle stretching. *Journal of applied physiology (Bethesda, Md.: 1985)*, 86(4), 1283-1291.
- Babault, N., Kouassi, B. Y. & Desbrosses, K. (2010). Acute effects of 15min static or contract-relax stretching modalities on plantar flexors neuromuscular properties. *Journal of science and medicine in sport / Sports Medicine Australia*, 13(2), 247-252.
- Bacurau, R. F., Monteiro, G. A., Ugrinowitsch, C., Tricoli, V., Cabral, L. F. & Aoki, M. S. (2009). Acute effect of a ballistic and a static stretching exercise bout on flexibility and maximal strength. *Journal of strength and conditioning research / National Strength & Conditioning Association*, 23(1), 304-308.
- Baechle, T. R., Earle, R. W. & Wathen, D. (2008). Resistance training. In T. R. Baechle, & R. W. Earle (3. ed.), *Essentials of strength training and conditioning* (pp. 381-411). Champaign, IL: Human Kinetics.
- Batista, M. A., Ugrinowitsch, C., Roschel, H., Lotufo, R., Ricard, M. D. & Tricoli, V. A. (2007). Intermittent exercise as a conditioning activity to induce postactivation potentiation. *Journal of Strength and Conditioning Research / National Strength & Conditioning Association*, 21(3), 837-840.
- Baudry, S. & Duchateau, J. (2004). Postactivation potentiation in human muscle is not related to the type of maximal conditioning contraction. *Muscle & Nerve*, 30(3), 328-336.
- Baudry, S. & Duchateau, J. (2007). Postactivation potentiation in a human muscle: Effect on the rate of torque development of tetanic and voluntary isometric contractions. *Journal of Applied Physiology (Bethesda, Md.: 1985)*, 102(4), 1394-1401.
- Bazett-Jones, D. M., Winchester, J. B. & McBride, J. M. (2005). Effect of potentiation and stretching on maximal force, rate of force development, and range of motion. *Journal of Strength and Conditioning Research / National Strength & Conditioning Association*, 19(2), 421-426.
- Beaulieu, J. E. (1981). Developing a stretching program. In *Physician Sports Medicine* (9. ed., pp. 59-69).
- Beckett, J. R., Schneiker, K. T., Wallman, K. E., Dawson, B. T. & Guelfi, K. J. (2009). Effects of static stretching on repeated sprint and change of direction performance. *Medicine and science in sports and exercise*, 41(2), 444-450.

- Begert, B. & Hillebrecht, M. (2003). Einfluss unterschiedlicher Dehntechniken auf die reaktive Leistungsfähigkeit. *Spectrum der Sportwissenschaften*, 15, 6-25.
- Behm, D. G., Bradbury, E. E., Haynes, A. T., Hodder, J. N., Leonard, A. M. & Paddock, N. R. (2006). Flexibility is not related to stretch-induced deficits in force or power. *Journal of Sports Science and Medicine*, 5, 33-42.
- Behm, D. G., Button, D. C., Barbour, G., Butt, J. C. & Young, W. B. (2004). Conflicting effects of fatigue and potentiation on voluntary force. *Journal of strength and conditioning research / National Strength & Conditioning Association*, 18(2), 365-372.
- Behm, D. G. & Kibele, A. (2007). Effects of differing intensities of static stretching on jump performance. *European Journal of Applied Physiology*, 101(5), 587-594.
- Berning, J. M., Adams, K. J., DeBeliso, M., Sevene-Adams, P. G., Harris, C. & Stamford, B. A. (2010). Effect of functional isometric squats on vertical jump in trained and untrained men. *Journal of strength and conditioning research / National Strength & Conditioning Association*, 24(9), 2285-2289.
- Bevan, H. R., Cunningham, D. J., Tooley, E. P., Owen, N. J., Cook, C. J. & Kilduff, L. P. (2010). Influence of postactivation potentiation on sprinting performance in professional rugby players. *Journal of strength and conditioning research / National Strength & Conditioning Association*, 24(3), 701-705.
- Billeter, R. & Hoppeler, H. (2003). Muscular basis of strength. In P. V. Komi, International Olympic Committee, International Federation of Sportive Medicine & International Olympic Committee. Medical Commission (Eds.), *Strength and power in sport* (2. ed., pp. 50-72). Oxford u.a.: Blackwell Science.
- Bishop, D. (2003a). Warm up I: potential mechanisms and the effects of passive warm up on exercise performance. *Sports medicine (Auckland, N.Z.)*, 33(6), 439-454.
- Bishop, D. (2003b). Warm up II: performance changes following active warm up and how to structure the warm up. *Sports medicine (Auckland, N.Z.)*, 33(7), 483-498.
- Blum, B. (2000). *Perfektes Stretching* (5. ed.). München: Copress Sport.
- Bojsen-Moller, J., Magnusson, S. P., Rasmussen, L. R., Kjaer, M. & Aagaard, P. (2005). Muscle performance during maximal isometric and dynamic contractions is influenced by the stiffness of the tendinous structures. *Journal of Applied Physiology*, 99, 986-994.
- Böning, D. (2000). Standards in der Sportmedizin - Muskelkater. *Deutsche Zeitschrift für Sportmedizin*, 51(2), 63-64.
- Bradley, P. S., Olsen, P. D. & Portas, M. D. (2007). The effect of static, ballistic, and proprioceptive neuromuscular facilitation stretching on vertical jump performance. *Journal of strength and conditioning research / National Strength & Conditioning Association*, 21(1), 223-226.
- Brandenburg, J. (2006). Duration of stretch does not influence the degree of force loss following static stretching. *Journal of Sports Medicine and Physical Fitness*, 46, 526-534.
- Brandenburg, J., Pitney, W. A., Luebbbers, P. E., Veera, A. & Czajka, A. (2007). Time course of changes in vertical-jumping ability after static stretching. *International journal of sports physiology and performance*, 2(2), 170-181.
- Brown, L. E. (2000). *Isokinetics in human performance*. Champaign, Ill: Human Kinetics Publ.

- Burkett, L. N., Phillips, W. T. & Ziuraitis, J. (2005). The best warm-up for the vertical jump in college-age athletic men. *Journal of Strength and Conditioning Research / National Strength & Conditioning Association*, 19(3), 673-676.
- Ce, E., Margonato, V., Casasco, M. & Veicsteinas, A. (2008). Effects of stretching on maximal anaerobic power: the roles of active and passive warm-ups. *Journal of strength and conditioning research / National Strength & Conditioning Association*, 22(3), 794-800.
- Chaouachi, A., Castagna, C., Chtara, M., Brughelli, M., Turki, O., Galy, O., et al. (2010). Effect of warm-ups involving static or dynamic stretching on agility, sprinting, and jumping performance in trained individuals. *Journal of strength and conditioning research / National Strength & Conditioning Association*, 24(8), 2001-2011.
- Chatzopoulos, D. E., Michailidis, C. J., Giannakos, A. K., Alexiou, K. C., Patikas, D. A., Antonopoulos, C. B., et al. (2007). Postactivation potentiation effects after heavy resistance exercise on running speed. *Journal of strength and conditioning research / National Strength & Conditioning Association*, 21(4), 1278-1281.
- Chiu, L. Z., Fry, A. C., Weiss, L. W., Schilling, B. K., Brown, L. E. & Smith, S. L. (2003). Postactivation potentiation response in athletic and recreationally trained individuals. *Journal of Strength and Conditioning Research / National Strength & Conditioning Association*, 17(4), 671-677.
- Church, J. B., Wiggins, M. S., Moode, F. M. & Crist, R. (2001). Effect of warm-up and flexibility treatments on vertical jump performance. *Journal of strength and conditioning research / National Strength & Conditioning Association*, 15(3), 332-336.
- Cornwell, A., Nelson, A. G. & Sidaway, B. (2002). Acute effects of stretching on the neuromechanical properties of the triceps surae muscle complex. *European Journal of Applied Physiology*, 86(5), 428-434.
- Costa, P. B., Ryan, E. D., Herda, T. J., DeFreitas, J. M., Beck, T. W. & Cramer, J. T. (2009). Effects of stretching on peak torque and the H:Q ratio. *30(1)*, 60-65.
- Cramer, J. T., Beck, T. W., Housh, T. J., Massey, L. L., Marek, S. M., Danglemeier, S., et al. (2007a). Acute effects of static stretching on characteristics of the isokinetic angle - torque relationship, surface electromyography, and mechanomyography. *Journal of Sports Sciences*, 25(6), 687-698.
- Cramer, J. T., Housh, T. J., Coburn, J. W., Beck, T. W. & Johnson, G. O. (2006). Acute effects of static stretching on maximal eccentric torque production in women. *Journal of strength and conditioning research / National Strength & Conditioning Association*, 20(2), 354-358.
- Cramer, J. T., Housh, T. J., Johnson, G. O., Miller, J. M., Coburn, J. W. & Beck, T. W. (2004). Acute effects of static stretching on peak torque in women. *Journal of strength and conditioning research / National Strength & Conditioning Association*, 18(2), 236-241.
- Cramer, J. T., Housh, T. J., Johnson, G. O., Weir, J. P., Beck, T. W. & Coburn, J. W. (2007b). An acute bout of static stretching does not affect maximal eccentric isokinetic peak torque, the joint angle at peak torque, mean power, electromyography, or mechanomyography. *The Journal of Orthopaedic and Sports Physical Therapy*, 37(3), 130-139.

- Cramer, J. T., Housh, T. J., Weir, J. P., Johnson, G. O., Coburn, J. W. & Beck, T. W. (2005). The acute effects of static stretching on peak torque, mean power output, electromyography, and mechanomyography. *European Journal of Applied Physiology*, 93(5-6), 530-539.
- Cronin, J., Nash, M. & Whatman, C. (2008). The acute effects of hamstring stretching and vibration on dynamic knee joint range of motion and jump performance. *Physical therapy in sport : official journal of the Association of Chartered Physiotherapists in Sports Medicine*, 9(2), 89-96.
- Cross, K. M. & Worrell, T. W. (1999). Effects of a static stretching program on the incidence of lower extremity musculotendinous strains. *Journal of athletic training*, 34(1), 11-14.
- Curry, B. S., Chengkalath, D., Crouch, G. J., Romance, M. & Manns, P. J. (2009). Acute effects of dynamic stretching, static stretching, and light aerobic activity on muscular performance in women. *Journal of strength and conditioning research / National Strength & Conditioning Association*, 23(6), 1811-1819.
- Dadebo, B., White, J. & George, K. P. (2004). A survey of flexibility training protocols and hamstring strains in professional football clubs in England. *British journal of sports medicine*, 38(4), 388-394.
- Dalrymple, K. J., Davis, S. E., Dwyer, G. B. & Moir, G. L. (2010). Effect of static and dynamic stretching on vertical jump performance in collegiate women volleyball players. *Journal of strength and conditioning research / National Strength & Conditioning Association*, 24(1), 149-155.
- De Luca, C. J. (1997). The Use of Surface Electromyography in Biomechanics. *Journal of applied Biomechanics*, 13, 135-163.
- Di Cagno, A., Baldari, C., Battaglia, C., Gallotta, M. C., Videira, M., Piazza, M., et al. (2010). Preexercise static stretching effect on leaping performance in elite rhythmic gymnasts. *Journal of strength and conditioning research / National Strength & Conditioning Association*, 24(8), 1995-2000.
- Edman, K. A. P. (2003). In P. V. Komi, International Olympic Committee, International Federation of Sportive Medicine & International Olympic Committee. Medical Commission (Eds.), *Strength and power in sport* (2. ed., pp. 114-133). Oxford u.a.: Blackwell Science.
- Egan, A. D., Cramer, J. T., Massey, L. L. & Marek, S. M. (2006). Acute effects of static stretching on peak torque and mean power output in National Collegiate Athletic Association Division I women's basketball players. *Journal of strength and conditioning research / National Strength & Conditioning Association*, 20(4), 778-782.
- Enoka, R. M. (2008). *Neuromechanics of human movement* (4. ed.). Champaign, Ill: Human Kinetics.
- Esformes, J. I., Cameron, N. & Bampouras, T. M. (2010). Postactivation potentiation following different modes of exercise. *Journal of strength and conditioning research / National Strength & Conditioning Association*, 24(7), 1911-1916.
- Evetovich, T. K., Cain, R. M., Hinnerichs, K. R., Engebretsen, B. J. & Conley, D. S. (2010). Interpreting normalized and nonnormalized data after acute static stretching in athletes and nonathletes. *Journal of strength and conditioning research / National Strength & Conditioning Association*, 24(8), 1988-1994.
- Evetovich, T. K., Nauman, N. J., Conley, D. S. & Todd, J. B. (2003). Effect of static stretching of the biceps brachii on torque, electromyography, and mechanomyogra-

- phy during concentric isokinetic muscle actions. *Journal of strength and conditioning research / National Strength & Conditioning Association*, 17(3), 484-488.
- Faigenbaum, A. D., Bellucci, M., Bernieri, A., Bakker, B. & Hoorens, K. (2005). Acute effects of different warm-up protocols on fitness performance in children. *Journal of Strength and Conditioning Research / National Strength & Conditioning Association*, 19(2), 376-381.
- Faigenbaum, A. D., McFarland, J. E., Kelly, N. A., Ratamess, N. A., Kang, J. & Hoffman, J. R. (2010). Influence of recovery time on warm-up effects in male adolescent athletes. *Pediatric exercise science*, 22(2), 266-277.
- Faigenbaum, A. D., McFarland, J. E., Schwerdtman, J. A., Ratamess, N. A., Kang, J. & Hoffman, J. R. (2006). Dynamic warm-up protocols, with and without a weighted vest, and fitness performance in high school female athletes. *Journal of athletic training*, 41(4), 357-363.
- Farup, J. & Sorensen, H. (2010). Postactivation potentiation: upper body force development changes after maximal force intervention. *Journal of strength and conditioning research / National Strength & Conditioning Association*, 24(7), 1874-1879.
- Favero, J. P., Midgley, A. W. & Bentley, D. J. (2009). Effects of an acute bout of static stretching on 40 m sprint performance: influence of baseline flexibility. *Research in sports medicine*, 17(1), 50-60.
- Fetz, F. & Kornexl, E. (1993). *Sportmotorische Tests : Praktische Anleitung zu Sportmotorischen Tests in Schule und Verein* (3. ed.). Wien: ÖBV, Pädagog. Verl.
- Fleck, S. J., & Kraemer, W. J. (2004). *Designing resistance training programs* (3rd ed.). Champaign, IL: Human Kinetics.
- Fletcher, I. M. & Anness, R. (2007). The acute effects of combined static and dynamic stretch protocols on fifty-meter sprint performance in track-and-field athletes. *Journal of strength and conditioning research / National Strength & Conditioning Association*, 21(3), 784-787.
- Fletcher, I. M. & Jones, B. (2004). The effect of different warm-up stretch protocols on 20 meter sprint performance in trained rugby union players. *Journal of Strength and Conditioning Research / National Strength & Conditioning Association*, 18(4), 885-888.
- Fowles, J. R., Sale, D. G. & MacDougall, J. D. (2000). Reduced strength after passive stretch of the human plantarflexors. *Journal of applied physiology (Bethesda, Md.: 1985)*, 89(3), 1179-1188.
- Freiwald, J. (2006). *Stretching für alle Sportarten* (Orig.-Ausg. ed.). Reinbek bei Hamburg: Rowohlt-Taschenbuch-Verl.
- Freiwald, J. (2009). *Optimales Dehnen*. Balingen: Spitta-Verl.
- Freiwald, J., Baumgart, C. & Konrad, P. (2007). *Einführung in die Elektromyographie: Sport - Prävention - Rehabilitation*. Balingen: Spitta.
- Friedrich, W. (2007). *Optimales Sportwissen* (2. ed.). Balingen: Spitta-Verl.
- Fröhlich, M., Emrich, E., Pieter, A. & Stark, R. (2009). Outcome effects and effects sizes in sport sciences. *International Journal of Sports Science and Engineering*, (3), 175-179.

- Fröhlich, M. & Pieter, A. (2009). Cohen's Effektstärken als Mass der Bewertung von praktischer Relevanz – Implikationen für die Praxis. *Schweizerische Zeitschrift für Sportmedizin und Sporttraumatologie*, (4), 139-142.
- Gamble, P. (2010). *Strength and conditioning for team sports: Sport-specific physical preparation for high performance*. London: Routledge.
- Glück, S. (2005). *Beeinflussung der Beweglichkeit durch unterschiedliche physische und psychische Einwirkungen*. Unpublished Dissertation, Saarland University, Saarbrücken.
- Glück, S., Schwarz, M., Hoffmann, U. & Wydra, G. (2002). Bewegungsreichweite, Zugkraft und Muskelaktivität bei eigen- bzw. fremdregulierter Dehnung. *Deutsche Zeitschrift für Sportmedizin*, 53(3), 66-71.
- González-Ravé, J. M., Machado, L., Navarro-Valdivielso, F. & Vilas-Boas, J. P. (2009). Acute effects of heavy-load exercises, stretching exercises, and heavy-load plus stretching exercises on squat jump and countermovement jump performance. *Journal of strength and conditioning research / National Strength & Conditioning Association*, 23(2), 472-479.
- Gore, C. J. (2000). *Physiological tests for elite athletes*. Champaign, Ill: Human Kinetics.
- Goulding, D., Bullard, B. & Gautel, M. (1997). A survey of in situ sarcomere extension in mouse skeletal muscle. *Journal of muscle research and cell motility*, 18(4), 465-472.
- Gourgoulis, V., Aggeloussis, N., Kasimatis, P., Mavromatis, G. & Garas, A. (2003). Effect of a submaximal half-squats warm-up program on vertical jumping ability. *Journal of Strength and Conditioning Research / National Strength & Conditioning Association*, 17(2), 342-344.
- Grosser, M., Starischka, S., Zimmermann, E. & Eisenhut, A. (2008). *Das neue Konditionstraining* (10. ed.). München: BLV-Buchverl.
- Guissard, N. & Duchateau, J. (2004). Effect of static stretch training on neural and mechanical properties of the human plantar-flexor muscles. *Muscle & nerve*, 29(2), 248-255.
- Guissard, N. & Duchateau, J. (2006). Neural aspects of muscle stretching. *Exercise and sport sciences reviews*, 34(4), 154-158.
- Hamada, T., Sale, D. G. & Macdougall, J. D. (2000). Postactivation potentiation in endurance-trained male athletes. *Medicine and Science in Sports and Exercise*, 32(2), 403-411.
- Hamilton, R. T., Schulz, S. J., Schmitz, R. J. & Perrin, D. H. (2008). Triple hop distance as a valid predictor of lower limb strength and power. *Journal of Athletic Training*, 43(2), 144-151.
- Handrakis, J. P., Southard, V. N., Abreu, J. M., Aloisa, M., Doyen, M. R., Echevarria, L. M., et al. (2010). Static Stretching Does Not Impair Performance in Active Middle-Aged Adults. *Journal of Strength and Conditioning Research*, 24(3), 825-830.
- Hanson, E. D., Leigh, S. & Mynark, R. G. (2007). Acute effects of heavy- and light-load squat exercise on the kinetic measures of vertical jumping. *Journal of Strength and Conditioning Research / National Strength & Conditioning Association*, 21(4), 1012-1017.

- Hart, L. (2005). Effect of stretching on sport injury risk: A review. *Clinical Journal of Sport Medicine : Official Journal of the Canadian Academy of Sport Medicine*, 15(2), 113.
- Hennig, E. & Podzielnny, S. (1994). Die Auswirkungen von Dehn- und Aufwärmübungen auf die Vertikalsprungleistung. *Deutsche Zeitschrift für Sportmedizin*, 45, 253 - 260.
- Herbert, R. D. & Gabriel, M. (2002). Effects of stretching before and after exercising on muscle soreness and risk of injury: systematic review. *British medical journal (Clinical research ed.)*, 325(7362), 468-473.
- Herda, T. J., Cramer, J. T., Ryan, E. D., McHugh, M. P. & Stout, J. R. (2008). Acute effects of static versus dynamic stretching on isometric peak torque, electromyography, and mechanomyography of the biceps femoris muscle. *Journal of strength and conditioning research / National Strength & Conditioning Association*, 22(3), 809-817.
- Hillebrecht, M. & Niedderer, F. (2006). Lassen sich Leistungseinbußen bezüglich der Reaktivkraft nach statischem Dehnen aufheben? *Sportwissenschaft*, 36(3), 306-320.
- Hillebrecht, M., Robin, O. & Böckmann, S. (2007). Trainingswissenschaft und -lehre - Reduzieren sich Sprintleistungen nach statischem Dehnen? *Leistungssport*, 37(6), 12-16.
- Hodgson, M., Docherty, D. & Robbins, D. (2005). Post-activation potentiation: Underlying physiology and implications for motor performance. *Sports Medicine (Auckland, N.Z.)*, 35(7), 585-595.
- Hoffman, J. R. (2007). Effects of maximal squat exercise testing on vertical jump performance in american college players. *Journal of Sports Science and Medicine*, 6, 149-150.
- Holt, B. W. & Lambourne, K. (2008). The impact of different warm-up protocols on vertical jump performance in male collegiate athletes. *Journal of Strength and Conditioning Research / National Strength & Conditioning Association*, 22(1), 226-229.
- Höss-Jelten, C. (2004). Untersuchungen zu den unmittelbaren Wirkungen verschiedener Dehnmethode n auf ausgewählte Kraftparameter. *Unpublished Dissertation*, Technische Universität, München.
- Hough, P. A., Ross, E. Z. & Howatson, G. (2009). Effects of dynamic and static stretching on vertical jump performance and electromyographic activity. *Journal of strength and conditioning research / National Strength & Conditioning Association*, 23(2), 507-512.
- Jacobs, B. (2005). *Einige Berechnungsmöglichkeiten von Effektstärken*. Retrieved 03.06.2011, from <http://www.phil.uni-sb.de/~jakobs/seminar/vpl/bedeutung/effektstaerketool.htm>
- Jeffreys, I. (2008). Warm-up and stretching. In T. R. Baechle, & R. W. Earle (Eds.), (3. ed., pp. 295-324). Champaign, IL: Human Kinetics.
- Johnson, D. L. & Bahamonde, R. E. (1996). Power output estimate in university athletes. *Journal of Strength and Conditioning Research / National Strength & Conditioning Association*, 10(3), 161-166.
- Kato, E. (2007). Effects of submaximal muscle contraction and stretching on vertical jump performance. *Journal of Biomechanics*, 40, 377-382
- Khamoui, A. V., Brown, L. E., Coburn, J. W., Judelson, D. A., Uribe, B. P., Nguyen, D., et al. (2009). *Effect of potentiating exercise volume on vertical jump parame-*

- ters in recreationally trained men. *Journal of strength and conditioning research / National Strength & Conditioning Association*, 23(5), 1465-1469.
- Kilduff, L. P., Bevan, H. R., Kingsley, M. I., Owen, N. J., Bennett, M. A., Bunce, P. J., et al. (2007). Postactivation potentiation in professional rugby players: optimal recovery. *Journal of strength and conditioning research / National Strength & Conditioning Association*, 21(4), 1134-1138.
- Kilduff, L. P., Owen, N., Bevan, H., Bennett, M., Kingsley, M. I. & Cunningham, D. (2008). Influence of recovery time on post-activation potentiation in professional rugby players. *Journal of sports sciences*, 26(8), 795-802.
- Kistler, B. M., Walsh, M. S., Horn, T. S. & Cox, R. H. (2010). The acute effects of static stretching on the sprint performance of collegiate men in the 60- and 100-m dash after a dynamic warm-up. *Journal of strength and conditioning research / National Strength & Conditioning Association*, 24(9), 2280-2284.
- Klee, A. (2006). Zur Wirkung des Dehnungstrainings als Verletzungsprophylaxe. *Sportwissenschaft*, (1), 23-38.
- Klee, A. & Wiemann, K. (2004a). Methoden und Wirkungen des Dehnungstrainings. Vortrag. In W. DSTV Freitag (Ed.), *Schwimmen - Lernen und Optimieren* (23. ed.), Rüsselsheim
- Klee, A. & Wiemann, K. (2004b). Biologische Grundlagen zur Wirkung der Muskeldehnung. In K. Cachey, A. Halle & H. Teubert (Eds.), *Sport ist Spitze. Reader zum Sportgespräch / 18. Internationaler Workshop am 16. und 17. Juni 2003 in Oberhausen* (pp. 88-102) Aachen: Meyer & Meyer.
- Knebel, K. P-. (1985). *Funktionsgymnastik*. Rowolth: Reinbek.
- Knudson, D. V., Noffal, G. J., Bahamonde, R. E., Bauer, J. A. & Blackwell, J. R. (2004). Stretching has no effect on tennis serve performance. *Journal of strength and conditioning research / National Strength & Conditioning Association*, 18(3), 654-656.
- Koch, A. J., O'Bryant, H. S., Stone, M. E., Sanborn, K., Proulx, C., Hrubby, J., et al. (2003). Effect of warm-up on the standing broad jump in trained and untrained men and women. *Journal of Strength and Conditioning Research / National Strength & Conditioning Association*, 17(4), 710-714.
- Komi, P. V. (2000). Stretch-shortening cycle: a powerful model to study normal and fatigued muscle. *Journal of Biomechanics*, 33(10), 1197-1206.
- Konrad, P. (2005). *The ABC of EMG: A practical introduction to kinesiological electromyography*. Unpublished manuscript, Cologne.
- Kovacs, M. (2006). The argument against static stretching before sport and physical activity. *Athletic Therapy Today*, 11(3), 6-8.
- Kovacs, M. (2010). *Dynamic stretching: The revolutionary new warm-up method to improve power, performance and range of motion*. Berkeley CA: Ulysses Press.
- Kunert, C. (2008). *Dehnen - lockern - entspannen* (1. ed.). Wiebelsheim: Limpert.
- La Torre, A., Castagna, C., Gervasoni, E., Ce, E., Rampichini, S., Ferrarin, M., et al. (2010). Acute effects of static stretching on squat jump performance at different knee starting angles. *Journal of strength and conditioning research / National Strength & Conditioning Association*, 24(3), 687-694.
- Linder, E. E., Prins, J. H., Murata, N. M., Derenne, C., Morgan, C. F. & Solomon, J. R. (2010). Effects of preload 4 repetition maximum on 100-m sprint times in colle-

- giate women. *Journal of strength and conditioning research / National Strength & Conditioning Association*, 24(5), 1184-1190.
- Linthorne, N. (2001). Analysis of standing vertical jumps using a force platform. *American Journal of Physics*, (11), 1198-1204.
- Little, T. & Williams, A. G. (2006). Effects of differential stretching protocols during warm-ups on high-speed motor capacities in professional soccer players. *Journal of strength and conditioning research / National Strength & Conditioning Association*, 20(1), 203-207.
- MacAuley, D. & Best, T. M. (2007). *Evidence-based sports medicine* (2. ed.). Oxford: Blackwell.
- MacIntosh, B. R., Gardiner, P. F. & McComas, A. J. (2006). *Skeletal muscle*. Champaign, Ill: Human Kinetics.
- Maehl, O. (1986). Beweglichkeitstraining. In H. Tiwald (Ed.), *Budo und transkulturelle Bewegungsforschung*. Ahrensburg: Czwalina.
- Magnusson, S. P., Simonsen, E. B., Aagaard, P. & Kjaer, M. (1996). Biomechanical responses to repeated stretches in human hamstring muscle in vivo. *The American Journal of Sports Medicine*, 24(5), 622-628.
- Mangus, B. C., Takahashi, M., Mercer, J. A., Holcomb, W. R., McWhorter, J. W. & Sanchez, R. (2006). Investigation of vertical jump performance after completing heavy squat exercises. *Journal of Strength and Conditioning Research / National Strength & Conditioning Association*, 20(3), 597-600.
- Manoel, M. E., Harris-Love, M. O., Danoff, J. V. & Miller, T. A. (2008). Acute effects of static, dynamic, and proprioceptive neuromuscular facilitation stretching on muscle power in women. *Journal of strength and conditioning research / National Strength & Conditioning Association*, 22(5), 1528-1534.
- Marek, S. M., Cramer, J. T., Fincher, A. L., Massey, L. L., Dangelmaier, S. M., Purkayastha, S., et al. (2005). Acute effects of static and proprioceptive neuromuscular facilitation stretching on muscle strength and power output. *Journal of athletic Training*, 40(2), 94-103.
- Markovic, G. & Jaric, S. (2004). Movement performance and body size: the relationship for different groups of tests. *European journal of applied physiology*, 92(1-2), 139-149.
- Maud, P. J. (2006). Fitness assessment defined. In P. J. Maud, & C. Foster (Eds.), *Physiological assessment of human fitness* (2. ed., pp. 1-8). Champaign, Ill. u.a.: Human Kinetics.
- McBride, J. M., Nimphius, S. & Erickson, T. M. (2005). The acute effects of heavy-load squats and loaded countermovement jumps on sprint performance. *Journal of Strength and Conditioning Research / National Strength & Conditioning Association*, 19(4), 893-897.
- McCann, M. R. & Flanagan, S. P. (2010). The effects of exercise selection and rest interval on postactivation potentiation of vertical jump performance. *Journal of strength and conditioning research / National Strength & Conditioning Association*, 24(5), 1285-1291.
- McMillian, D. J., Moore, J. H., Hatler, B. S. & Taylor, D. C. (2006). Dynamic vs. static-stretching warm up: the effect on power and agility performance. *Journal of strength and conditioning research / National Strength & Conditioning Association*, 20(3), 492-499.

- Miles, M. P. & Clarkson, P. M. (1994). Exercise-induced muscle pain, soreness, and cramps. *The Journal of sports medicine and physical fitness*, 34(3), 203-216.
- Miyamoto, N., Kanehisa, H., Fukunaga, T. & Kawakami, Y. (2010). Effect of Postactivation Potentiation on the Maximal Voluntary Isokinetic Concentric Torque in Humans. *Journal of strength and conditioning research / National Strength & Conditioning Association*, 25(1), 186-192
- Molacek, Z. D., Conley, D. S., Evetovich, T. K. & Hinnerichs, K. R. (2010). Effects of low- and high-volume stretching on bench press performance in collegiate football players. *Journal of strength and conditioning research / National Strength & Conditioning Association*, 24(3), 711-716.
- Murphy, J. R., Di Santo, M. C., Alkanani, T. & Behm, D. G. (2010). Aerobic activity before and following short-duration static stretching improves range of motion and performance vs. a traditional warm-up. *Applied physiology, nutrition, and metabolism = Physiologie appliquee, nutrition et metabolisme*, 35(5), 679-690.
- Nelson, A. G., Allen, J. D., Cornwell, A. & Kokkonen, J. (2001b). Inhibition of maximal voluntary isometric torque production by acute stretching is joint-angle specific. *Research quarterly for exercise and sport*, 72(1), 68-70.
- Nelson, A. G., Driscoll, N. M., Landin, D. K., Young, M. A. & Schexnayder, I. C. (2005). Acute effects of passive muscle stretching on sprint performance. *Journal of sports sciences*, 23(5), 449-454.
- Nelson, A. G., Guillory, I. K., Cornwell, C. & Kokkonen, J. (2001a). Inhibition of maximal voluntary isokinetic torque production following stretching is velocity-specific. *Journal of strength and conditioning research / National Strength & Conditioning Association*, 15(2), 241-246.
- Nelson, A. G. & Kokkonen, J. (2007). *Stretching anatomy*. Champaign, IL: Human Kinetics.
- Norihiro, S., Akira, A. & Hiduetsugu, N. (2006). The effects of postactivation potentiation on muscular strength and power. *Descende Sports Science*, , 217-223.
- O'Connor, D. M., Crowe, M. J. & Spinks, W. L. (2006). Effects of static stretching on leg power during cycling. *The Journal of sports medicine and physical fitness*, 46(1), 52-56.
- Ogura, Y., Miyahara, Y., Naito, H., Katamoto, S. & Aoki, J. (2007). Duration of static stretching influences muscle force production in hamstring muscles. *Journal of strength and conditioning research / National Strength & Conditioning Association*, 21(3), 788-792.
- Parry, S., Hancock, S., Shiells, M., Passfield, L., Davies, B. & Baker, J. S. (2008). Physiological effects of two different postactivation potentiation training loads on power profiles generated during high intensity cycle ergometer exercise. *Research in Sports Medicine*, 16(1), 56-67.
- Pearce, A. J., Kidgell, D. J., Zois, J. & Carlson, J. S. (2009). Effects of secondary warm up following stretching. *European journal of applied physiology*, 105(2), 175-183.
- Perrier, E. T., Pavol, M. J. & Hoffman, M. A. (2011). The acute effects of a warm-up including static or dynamic stretching on countermovement jump height, reaction time, and flexibility. *Journal of strength and conditioning research / National Strength & Conditioning Association*, 25(7), 1925-1931.

- Pope, R. P., Herbert, R. & Kirwan, J. (1998). Effects of ankle dorsiflexion range and pre-exercise calf muscle stretching on injury risk in Army recruits. *The Australian journal of physiotherapy*, 44(3), 165-172.
- Pope, R. P., Herbert, R. D., Kirwan, J. D. & Graham, B. J. (2000). A randomized trial of preexercise stretching for prevention of lower-limb injury. *Medicine and science in sports and exercise*, 32(2), 271-277.
- Power, K., Behm, D., Cahill, F., Carroll, M. & Young, W. (2004). An acute bout of static stretching: effects on force and jumping performance. *Medicine and science in sports and exercise*, 36(8), 1389-1396.
- Quagliarella, L., Sasanelli, N., Belgiovine, G., Moretti, L. & Moretti, B. (2010). Evaluation of standing vertical jump by ankles acceleration measurement. *Journal of strength and conditioning research / National Strength & Conditioning Association*, 24(5), 1229-1236.
- Raez, M. B., Hussain, M. S. & Mohd-Yasin, F. (2006). Techniques of EMG signal analysis: detection, processing, classification and applications. *Biological Procedures Online*, 8, 11-35.
- Rahimi, R. (2007). The acute effects of heavy versus light-load squats on sprint performance. *Physical Education and Sport*, 5(2)163-169.
- Rief, W. & Birbaumer, N. (2006). *Biofeedback : Grundlagen, Indikationen, Kommunikation, praktisches Vorgehen in der Therapie ; mit 53 Tabellen* (2. ed.). Stuttgart u.a.: Schattauer.
- Rixon, K. P., Lamont, H. S. & Bembem, M. G. (2007). Influence of type of muscle contraction, gender, and lifting experience on postactivation potentiation performance. *Journal of Strength and Conditioning Research / National Strength & Conditioning Association*, 21(2), 500-505.
- Robbins, D. W. (2005). Postactivation potentiation and its practical applicability: A brief review. *Journal of Strength and Conditioning Research / National Strength & Conditioning Association*, 19(2), 453-458.
- Robbins, J. W. & Scheuermann, B. W. (2008). Varying amounts of acute static stretching and its effect on vertical jump performance. *Journal of strength and conditioning research / National Strength & Conditioning Association*, 22(3), 781-786.
- Rosenbaum, D. & Hennig, E. M. (1997). Veränderung der Reaktionszeit und Explosivkraftentfaltung nach einem passiven Stretchingprogramm und 10minütigem Aufwärmen. *Deutsche Zeitschrift für Sportmedizin*, 48, 95 - 99.
- Rubini, E. C., Costa, A. L. & Gomes, P. S. (2007). The effects of stretching on strength performance. *Sports Medicine (Auckland, N.Z.)*, 37(3), 213-224.
- Ryan, E. D., Beck, T. W., Herda, T. J., Hull, H. R., Hartman, M. J., Stout, J. R., et al. (2008). Do practical durations of stretching alter muscle strength? A dose-response study. *Medicine and science in sports and exercise*, 40(8), 1529-1537.
- Saez Saez de Villarreal, E., Gonzalez-Badillo, J. J. & Izquierdo, M. (2007). Optimal warm-up stimuli of muscle activation to enhance short and long-term acute jumping performance. *European Journal of Applied Physiology*, 100(4), 393-401.
- Sale, D. G. (2004). Postactivation potentiation: Role in performance. *British Journal of Sports Medicine*, 38(4), 386-387.
- Sale, D. G. (2002). Postactivation potentiation: Role in human performance. *Exercise and Sport Sciences Reviews*, 30(3), 138-143.

- Samuel, M. N., Holcomb, W. R., Guadagnoli, M. A., Rubley, M. D. & Wallmann, H. (2008). Acute effects of static and ballistic stretching on measures of strength and power. *Journal of strength and conditioning research / National Strength & Conditioning Association*, 22(5), 1422-1428.
- Sayers, A. L., Farley, R. S., Fuller, D. K., Jubenville, C. B. & Caputo, J. L. (2008). The effect of static stretching on phases of sprint performance in elite soccer players. *Journal of strength and conditioning research / National Strength & Conditioning Association*, 22(5), 1416-1421.
- Schneider, K. & Wydra, G. (2001). Auswirkungen unterschiedlicher Entspannungsverfahren auf die Veränderung der Befindlichkeit. *Gesundheitssport und Sporttherapie*, 17, 10-15.
- Schneider, S., Schmitt, H., Zalewski, M. & Gantz, S. (2011). Dehnst Du noch oder grübelst Du schon?– Aktuelle Daten zu Akzeptanz und Verbreitung von Stretching im Leistungssport. *Deutsche Zeitschrift für Sportmedizin*, (3), 75-78.
- Scott, S. L. & Docherty, D. (2004). Acute effects of heavy preloading on vertical and horizontal jump performance. *Journal of strength and conditioning research / National Strength & Conditioning Association*, 18(2), 201-205.
- Sekir, U., Arabaci, R., Akova, B. & Kadagan, S. M. (2010). Acute effects of static and dynamic stretching on leg flexor and extensor isokinetic strength in elite women athletes. *Scandinavian journal of medicine & science in sports*, 20(2), 268-281.
- SENIAM. (2011) *Surface electromyography for the non-invasive assessment of muscles*. Retrieved 05/02, 2011, from <http://www.seniam.org/>
- Sherwood, L. (2006). *Fundamentals of physiology* (3rd ed.). Belmont Calif, London: Brooks/Cole; Thomson Learning [distributor].
- Shrier, I. (1999). Stretching before exercise does not reduce the risk of local muscle injury: A critical review of the clinical and basic science literature. *Clinical Journal of Sport Medicine : Official Journal of the Canadian Academy of Sport Medicine*, 9(4), 221-227.
- Shrier, I. (2004). Does stretching improve performance?: a systematic and critical review of the literature. *Clinical Journal of Sport Medicine*, 14(5), 267-273.
- Shrier, I. (2007). Does stretching help prevent injuries. In D. MacAuley, & T. M. Best (Eds.), *Evidence-based sports medicine* (2. ed., pp. 36-58). Oxford: Wiley-Blackwell.
- Siatras, T. A., Mittas, V. P., Mameletzi, D. N. & Vamvakoudis, E. A. (2008). The duration of the inhibitory effects with static stretching on quadriceps peak torque production. *Journal of Strength and Conditioning Research / National Strength & Conditioning Association*, 22(1), 40-46.
- Sim, A. Y., Dawson, B. T., Guelfi, K. J., Wallman, K. E. & Young, W. B. (2009). Effects of static stretching in warm-up on repeated sprint performance. *Journal of strength and conditioning research / National Strength & Conditioning Association*, 23(7), 2155-2162.
- Smith, L. L., Brunetz, M. H., Chenier, T. C., McCammon, M. R., Houmard, J. A., Franklin, M. E., et al. (1993). The effects of static and ballistic stretching on delayed onset muscle soreness and creatine kinase. *Research quarterly for exercise and sport*, 64(1), 103-107.
- Sölveborn, S. A. (1983). *Das Buch vom Stretching. Beweglichkeitstraining durch Dehnen und Strecken*. München: Mosaik.

- Stockbrugger, B. A. & Haennel, R. G. (2001). Validity and reliability of a medicine ball explosive power test. *15*(4), 431-438.
- Strauß, T. & Wydra, G. (2010). Trainingswissenschaft und -lehre Untersuchungen zum Einfluss von statischem Dehnen auf die Wurfgeschwindigkeit im Handball. *Leistungssport*, *40*(6), 35-38.
- Taylor, K. L., Sheppard, J. M., Lee, H., & Plummer, N. (2009). Negative effect of static stretching restored when combined with a sport specific warm-up component. *Journal of science and medicine in sport / Sports Medicine Australia*, *12*(6), 657-661.
- Till, K. A. & Cooke, C. (2009). The effects of postactivation potentiation on sprint and jump performance of male academy soccer players. *Journal of strength and conditioning research / National Strength & Conditioning Association*, *23*(7), 1960-1967.
- Torres, E. M., Kraemer, W. J., Vingren, J. L., Volek, J. S., Hatfield, D. L., Spiering, B. A., et al. (2008). Effects of stretching on upper-body muscular performance. *Journal of strength and conditioning research / National Strength & Conditioning Association*, *22*(4), 1279-1285.
- Turbanski, S. (2005). Trainingswissenschaft und -lehre - Aufwärmeeffekt von Stretching in Sportarten und Disziplinen mit Schnellkraftanforderungen. *Leistungssport*, *35*(2), 20-23.
- Unick, J., Kieffer, H. S., Cheesman, W. & Feeney, A. (2005). The acute effects of static and ballistic stretching on vertical jump performance in trained women. *Journal of strength and conditioning research / National Strength & Conditioning Association*, *19*(1), 206-212.
- Vetter, R. E. (2007). Effects of six warm-up protocols on sprint and jump performance. *Journal of Strength and Conditioning Research / National Strength & Conditioning Association*, *21*(3), 819-823.
- Walker, B. (2007). *The anatomy of stretching*. Chichester: Lotus Publishing.
- Wallmann, H. W., Mercer, J. A. & Landers, M. R. (2008). Surface electromyographic assessment of the effect of dynamic activity and dynamic activity with static stretching of the gastrocnemius on vertical jump performance. *Journal of strength and conditioning research / National Strength & Conditioning Association*, *22*(3), 787-793.
- Wallmann, H. W., Mercer, J. A. & McWhorter, J. W. (2005). Surface electromyographic assessment of the effect of static stretching of the gastrocnemius on vertical jump performance. *Journal of Strength and Conditioning Research / National Strength & Conditioning Association*, *19*(3), 684-688.
- Weber, K. R., Brown, L. E., Coburn, J. W. & Zinder, S. M. (2008). Acute effects of heavy-load squats on consecutive squat jump performance. *Journal of strength and conditioning research / National Strength & Conditioning Association*, *22*(3), 726-730.
- Wick, D. (2009). *Biomechanik im Sport : Lehrbuch der biomechanischen Grundlagen sportlicher Bewegungen* (2. ed.). Balingen: Spitta-Verl.
- Wiemann, K. (1991). Beeinflussung muskulärer Parameter durch ein zehnwöchiges Dehnungstraining. *Sportwissenschaft*, *21*(3), 295-306.

- Wiemann, K. (1994). Beeinflussung muskulärer Parameter durch unterschiedliche Dehnverfahren. In M. Hoster, & H. - Nepper (Eds.), *Dehnen und Mobilisieren. Sport-, Gymnastik- und Krankengymnastikschule Waldenburg* (pp. 40-71)
- Wiemann, K., Klee, A. & Stratmann, M. (1998). Filamentäre Quellen der Muskel-Ruhespannung und die Behandlung muskulärer Dysbalancen. *Deutsche Zeitschrift für Sportmedizin*, 48(4), 111-118.
- Wiemann, K. & Leisner, S. (1996). Extreme Hüftbeugefähigkeit von Turnern - Sind längere ischiokrurale Muskeln die Ursache? *TW Sport + Medizin*, 8(2), 103-108.
- Wiemann, K. & Klee, A. (2000). Biomechanik - Die Bedeutung von Dehnen und Stretching in der Aufwärmphase vor Höchstleistungen. *Leistungssport*, 30(4), 5-9.
- Wiemeyer, J. (2002). Dehnen - eine sinnvolle Vorbereitungsmaßnahme im Sport? *Spectrum der Sportwissenschaften*, 14(1), 53-80.
- Wiemeyer, J. (2003). Dehnen und Leistung - primär psychophysiologische Entspannungseffekte? *Deutsche Zeitschrift für Sportmedizin*, 54(10), 288-294.
- Winchester, J. B., Nelson, A. G. & Kokkonen, J. (2009). A single 30-s stretch is sufficient to inhibit maximal voluntary strength. *Research quarterly for exercise and sport*, 80(2), 257-261.
- Winchester, J. B., Nelson, A. G., Landin, D., Young, M. A. & Schexnayder, I. C. (2008). Static stretching impairs sprint performance in collegiate track and field athletes. *Journal of strength and conditioning research / National Strength & Conditioning Association*, 22(1), 13-19.
- Winke, M. R., Jones, N. B., Berger, C. G. & Yates, J. W. (2010). Moderate static stretching and torque production of the knee flexors. *Journal of strength and conditioning research / National Strength & Conditioning Association*, 24(3), 706-710.
- Witvrouw, E., Mahieu, N., Danneels, L. & McNair, P. (2004). Stretching and injury prevention: an obscure relationship. *Sports medicine (Auckland, N.Z.)*, 34(7), 443-449.
- Wydra, G. (1997). Stretching - ein Überblick über den aktuellen Stand der Forschung. *Sportwissenschaft*, 27, 409-427.
- Wydra, G. (2002). Dynamisches Dehnen besser als Stretching? *Gesundheitssport und Sporttherapie*, 18, 124-128.
- Wydra, G. (2003). Zur Effektivität verschiedener Dehntechniken unter besonderer Berücksichtigung von Seitenunterschieden. *Krankengymnastik. Zeitschrift für Physiotherapie*, 55, 602-607.
- Wydra, G. (2006). Dehnfähigkeit. In K. Bös, & W. Brehm (Eds.), *Handbuch Gesundheitssport* (pp. 265-274) Schorndorf: Hofmann.
- Wydra, G., Bös, K. & Karisch, G. (1991). Zur Effektivität verschiedener Dehntechniken. *Deutsche Zeitschrift für Sportmedizin*, 42, 386-400.
- Wydra, G. & Glück, S. (2004). Zur Effektivität des Dehnens. In K. Cachay, A. Halle & H. Teubert (Eds.), *Sport ist Spitze - Nachwuchsleistungssport aktuell zwischen Computer und Power-Food* (pp. 103-118) Aachen: Meyer & Meyer.
- Wydra, G., Glück, S. & Roemer, K. (1999). Kurzfristige Effekte verschiedener singulärer Muskeldehnungen. *Deutsche Zeitschrift für Sportmedizin*, 50(1), 10-16.

- Yamaguchi, T. & Ishii, K. (2005). Effects of static stretching for 30 seconds and dynamic stretching on leg extension power. *Journal of strength and conditioning research / National Strength & Conditioning Association*, 19(3), 677-683.
- Yamaguchi, T., Ishii, K., Yamanaka, M. & Yasuda, K. (2006). Acute effect of static stretching on power output during concentric dynamic constant external resistance leg extension. *Journal of strength and conditioning research / National Strength & Conditioning Association*, 20(4), 804-810.
- Yetter, M. & Moir, G. L. (2008). The acute effects of heavy back and front squats on speed during forty-meter sprint trials. *Journal of Strength and Conditioning Research / National Strength & Conditioning Association*, 22(1), 159-165.
- Ylinen, J. J. (2008). *Stretching therapy*. Edinburgh: Churchill Livingstone Elsevier.
- Young, W. B. & Behm, D. G. (2002). Should static stretching be used during a warm-up for strength and power activities? *National Strength & Conditioning Association*, 24(6), 33-37.
- Young, W. B., Elias, G. & Power, J. (2006). Effects of static stretching volume and intensity on plantar flexor explosive force production and range of motion. *The Journal of sports medicine and physical fitness*, 46(3), 403-411.
- Young, W. B. & Elliott, S. (2001). Acute effects of static stretching, proprioceptive neuromuscular facilitation stretching, and maximum voluntary contractions on explosive force production and jumping performance. *Research quarterly for exercise and sport*, 72(3), 273-279.
- Young, W. B. (2007). The use of static stretching in warm-up for training and competition. *International journal of sports physiology and performance*, 2(2), 212-216.
- Young, W. B. & Behm, D. G. (2003). Effects of running, static stretching and practice jumps on explosive force production and jumping performance. *The Journal of Sports Medicine and Physical Fitness*, 43(1), 21-27.

List of Figures

Figure 1:	The aerobic and anaerobic contribution with (a) and without (b) prior warm-up. VO ₂ : oxygen consumption, Eq: oxygen equivalents.....	12
Figure 2:	Comparison between normal areas of flexibility in soccer players and ballet dancers.....	22
Figure 3:	Structure of the muscle.....	24
Figure 4:	An electro microscopic photo of the sarcomere.....	24
Figure 5:	The sarcomere's principal structure.....	25
Figure 6:	Stretching tension curve of a muscle.....	26
Figure 7:	The force of titin filaments works to restore the original length of sarcomere and the extent of overlap of actin and myosin filaments of a half sarcomere in three stretching degrees.....	27
Figure 8:	Stretching tension on muscle fiber, tendons, muscle-tendon-junctions, tendon-bone-junctions and connective tissues.....	27
Figure 9:	The force-length-curve in relation to the varied overlap extent of myosin and actin filaments in a half sarcomere.....	29
Figure 10:	Variations of static and dynamic stretching.....	32
Figure 11:	Five types of stretching.....	35
Figure 12:	Categorization to self or external stretching.....	37
Figure 13:	Stretching-measure-sledge.....	38
Figure 14:	Change in maximum reachable range of motion in relation to the number of repetitions and the stretch-method.....	39
Figure 15:	Survival curves from studies of Pope et al. (1998) and Pope et al. (2000) showing risk of injury in army recruits undergoing training	40
Figure 16:	Electron micrograph showed the delayed-onset muscle soreness.....	41
Figure 17:	Measurements of hip flexion range of motion.....	79
Figure 18:	The rhythm and amplitude of accomplishing the stretching exercises of the first study in a static or dynamic type.....	80
Figure 19:	The effects of static stretching, dynamic stretching or rest on isokinetic peak torque.....	83
Figure 20:	The effects of static stretching, dynamic stretching or rest on angle at peak torque.....	84
Figure 21:	The effects of static stretching, dynamic stretching or rest on hip flexion range of motion.....	85
Figure 22:	Effect of static stretching on triple-hop distance.....	94
Figure 23:	Effect of static stretching followed by (JU), (SQ), (ISO) or (REST) on triple-hop distance.....	95

Figure 24: Effect of various exercises on triple-hop distance.....	96
Figure 25: A motor unit of a skeletal muscle.....	100
Figure 26: Schematic illustration of depolarization/ repolarization cycle.....	101
Figure 27: Propagating of an action potential along a single muscle fiber.....	102
Figure 28: The relationship between EMG-input and force-output of three various muscles.....	103
Figure 29: Raw signal recorded from a Kistler force plate and muscles activity.....	104
Figure 30: EMG-Signal processing.....	106
Figure 31: Effect of stretching, weighted jumps, or rest (control) on jump height....	110
Figure 32: Effect of stretching, weighted jump, or rest (control) on peak force.....	111
Figure 33: Effect of stretching, weighted jump, or rest (control) on contact time.....	111
Figure 34: Effect of stretching, weighted jump, or rest (control) on muscles activity (IEMG) in m. gastrocnemius medialis.....	112
Figure 35: Effect of stretching, weighted jump, or rest (control) on muscles activity (IEMG) in m. gastrocnemius lateralis.....	113
Figure 36: Effect of stretching, weighted jump, or rest (control) on muscles activity (IEMG) in m. vastus medialis.....	113
Figure 37: Effect of stretching, weighted jump, or rest (control) on muscles activity (IEMG) in m. vastus medialis.....	114

List of tables

Table 1:	A review to the acute effects of various activation-exercises athletic performance	15
Table 2:	Efficiency of five types of stretching in improving the flexibility.....	36
Table 3:	A review of researches in which an acute effect of static stretching on force, torque and jump performance was found.....	43
Table 4:	A review of researches in which NO acute effect of static stretching on force, torque and jump performance was found.....	56
Table 5:	Descriptive statistics (mean $M \pm$ standard deviation SD) for age, height and mass of the subjects (n=17) in the first study.....	78
Table 6:	Tests and treatments order in the first study.....	81
Table 7:	Means \pm standard deviations of isokinetic peak torques (Nm) across the four conditions and the two test-times	83
Table 8:	Means \pm standard deviations of angle at peak torque ($^{\circ}$) across the four conditions and the two test-times.....	84
Table 9:	Means \pm standard deviations of hip flexion range of motion ($^{\circ}$) across three conditions and the two test-times.....	85
Table 10:	Descriptive statistics (mean $M \pm$ standard deviation SD) for age, height and mass of the subjects (n=20) in the second study.....	89
Table 11:	Tests and treatments order in the second study.....	92
Table 12:	Means and standard deviations of jump distances (cm) in triple-hop test across the eight protocols.....	93
Table 13:	Descriptive statistics /mean $M \pm$ standard deviation SD/ for age, height and weight of the subjects (n=30) in the third study.....	99
Table 14:	Procedures order in the third study.....	107
Table 15:	Results of the estimated one repetition maximum test.....	109
Table 16:	Means \pm standard deviations of jump heights (cm) in countermovement jump test across the two conditions and the three test times.....	109
Table 17:	Means \pm standard deviations of contact time and peak force in countermovement jump test across the two conditions and the three test times...	110
Table 18:	Means \pm standard deviations of IEMG (mV) in the four investigated muscles by CMJ-test across the two conditions and the three test times.....	112

Appendix

Tab. 1: Tests of normal distribution in the first study

Variable	Normalverteilungstest (
	N	max D	K-S p
ROMA1: Beweglichkeit Vortest bei Bedingung A	17	0,161501	p >0,20
ROMA2: Beweglichkeit Nachtest bei Bedingung A	17	0,187429	p >0,20
FmaxA1: Max Drehmoment Vortest bei Bedingung A	17	0,130182	p >0,20
FmaxA2: Max Drehmoment Nachtest bei Bedingung A	17	0,179589	p >0,20
WinkelA1: Optimalwinkel Vortest bei Bedingung A	17	0,137877	p >0,20
WinkelA2: Optimalwinkel Nachtest bei Bedingung A	17	0,179820	p >0,20
ROMB1: Beweglichkeit Vortest bei Bedingung B	17	0,220801	p >0,20
ROMB2: Beweglichkeit Nachtest bei Bedingung B	17	0,118807	p >0,20
FmaxB1: Max Drehmoment Vortest bei Bedingung B	17	0,139536	p >0,20
FmaxB2: Max Drehmoment Nachtest bei Bedingung B	17	0,141280	p >0,20
WinkelB1: Optimalwinkel Vortest bei Bedingung B	17	0,228881	p >0,20
WinkelB2: Optimalwinkel Nachtest bei Bedingung B	17	0,188350	p >0,20
ROMC1: Beweglichkeit Vortest bei Bedingung C	17	0,132062	p >0,20
ROMC2: Beweglichkeit Nachtest bei Bedingung C	17	0,117114	p >0,20
FmaxC1: Max Drehmoment Vortest bei Bedingung C	17	0,101126	p >0,20
FmaxC2: Max Drehmoment Nachtest bei Bedingung C	17	0,176377	p >0,20
WinkelC1: Optimalwinkel Vortest bei Bedingung C	17	0,311030	p < ,10
WinkelC2: Optimalwinkel Nachtest bei Bedingung C	17	0,208343	p >0,20
FmaxD1: Max Drehmoment Vortest bei Bedingung D	17	0,141592	p >0,20
FmaxD2: Max Drehmoment Nachtest bei Bedingung D	17	0,147556	p >0,20
WinkelD1: Optimalwinkel Vortest bei Bedingung D	17	0,216285	p >0,20
WinkelD2: Optimalwinkel Nachtest bei Bedingung D	17	0,122577	p >0,20

Tab. 2: Test-retest reliability of peak torques in the first study

Variable	Korrelationen (WS2006) Markierte Korr. signifikant für p < ,05000 N=17 (Fallweiser Ausschluss von MD)			
	FmaxA1	FmaxB1	FmaxC1	FmaxD1
FmaxA1	1,00	0,94	0,91	0,92
FmaxB1	0,94	1,00	0,93	0,95
FmaxC1	0,91	0,93	1,00	0,90
FmaxD1	0,92	0,95	0,90	1,00

Tab. 3: Test-retest reliability of angle at peak torque in the first study

Variable	Korrelationen (WS2006) Markierte Korr. signifikant für $p < ,05000$ N=17 (Fallweiser Ausschluss von MD)			
	WinkelA1	WinkelB1	WinkelC1	WinkelD1
WinkelA1	1,00	-0,08	0,26	0,32
WinkelB1	-0,08	1,00	0,28	0,55
WinkelC1	0,26	0,28	1,00	0,03
WinkelD1	0,32	0,55	0,03	1,00

Tab. 4: Test-retest reliability of hip range of motion in the first study

Variable	Korrelationen (WS2006) Markierte Korr. signifikant für $p < ,05000$ N=17 (Fallweiser Ausschluss von MD)		
	ROMA1	ROMB1	ROMC1
ROMA1	1,00	0,93	0,91
ROMB1	0,93	1,00	0,92
ROMC1	0,91	0,92	1,00

Tab. 5: Test of normal distribution in the second study

Variable	Normalverteilungstest (
	N	max D	K-S p
VT. PS	20	0,129822	$p > 0,20$
NT. PS	20	0,170028	$p > 0,20$
VT. SQ	20	0,152731	$p > 0,20$
NT. SQ	20	0,213041	$p > 0,20$
VT. STH	20	0,135562	$p > 0,20$
NT. STH	20	0,135724	$p > 0,20$
VT. KG	20	0,110500	$p > 0,20$
NT. KG	20	0,143674	$p > 0,20$
VT. DH+PS	20	0,137028	$p > 0,20$
NT.1 DH+PS	20	0,118142	$p > 0,20$
NT.2 DH+PS	20	0,112636	$p > 0,20$
VT. DH+SQ	19	0,127179	$p > 0,20$
NT.1 DH+SQ	19	0,104013	$p > 0,20$
NT.2 DH+SQ	19	0,147106	$p > 0,20$
VT. DH+STH	19	0,104903	$p > 0,20$
NT.1 DH+STH	19	0,104386	$p > 0,20$
NT.2 DH+STH	19	0,138653	$p > 0,20$
VT. DH+KG	19	0,128283	$p > 0,20$
NT.1 DH+KG	19	0,156538	$p > 0,20$
NT.2 DH+KG	19	0,140251	$p > 0,20$

Tab. 6: Test-retest reliability of jump distances in triple-hop-test in the second study

	JU	SQ	ISO	REST	SS+JU	SS+SQ	SS+ISO	SS+REST
JU	1,00	0,97	0,95	0,97	0,98	0,96	0,97	0,97
SQ	0,97	1,00	0,98	0,96	0,97	0,98	0,95	0,95
ISO	0,95	0,98	1,00	0,92	0,96	0,95	0,94	0,94
REST	0,97	0,96	0,92	1,00	0,97	0,96	0,93	0,93
SS+ JU	0,98	0,97	0,96	0,97	1,00	0,97	0,96	0,96
SS+ SQ	0,96	0,98	0,95	0,96	0,97	1,00	0,96	0,94
SS+ ISO	0,97	0,95	0,94	0,93	0,96	0,96	1,00	0,96
SS+REST	0,97	0,95	0,94	0,93	0,96	0,94	0,96	1,00

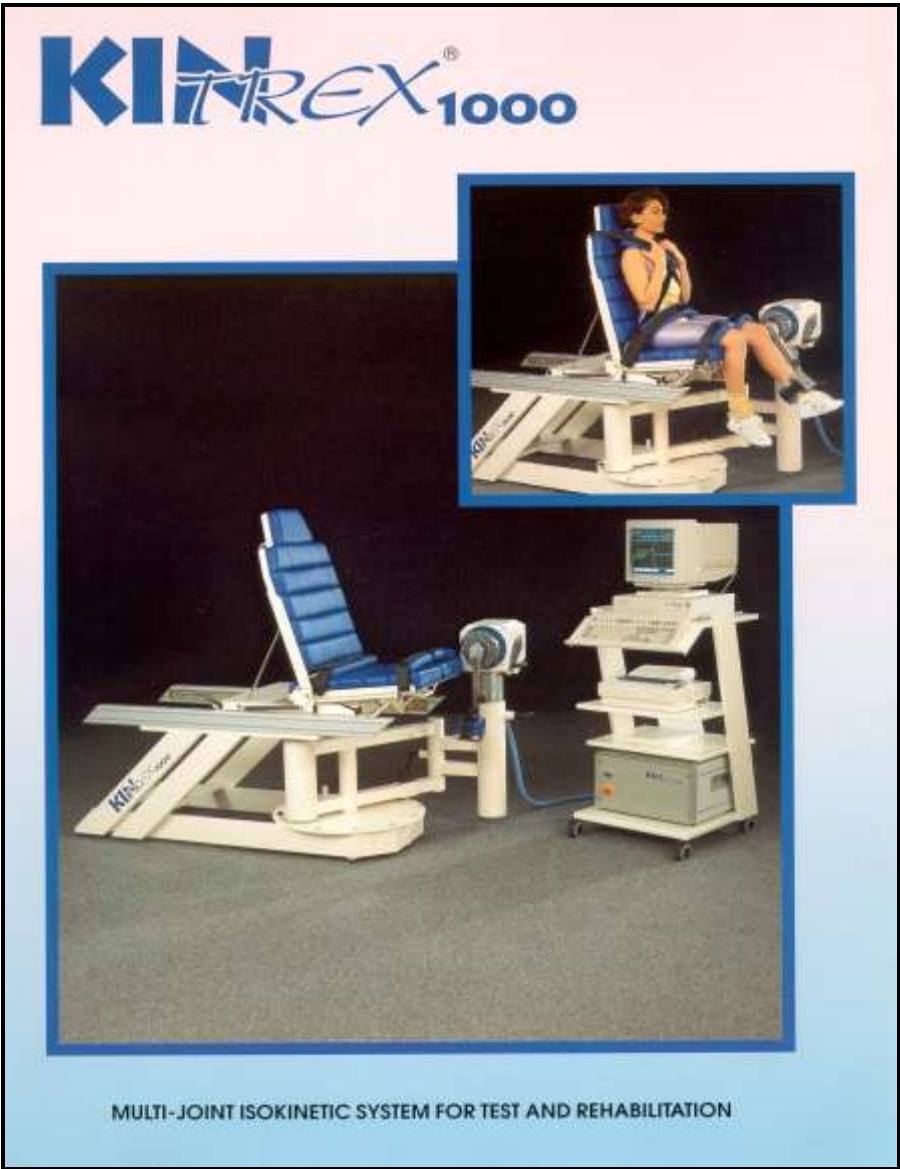

Fig. 1: The isokinetic dynamometer from Kintrex 1000

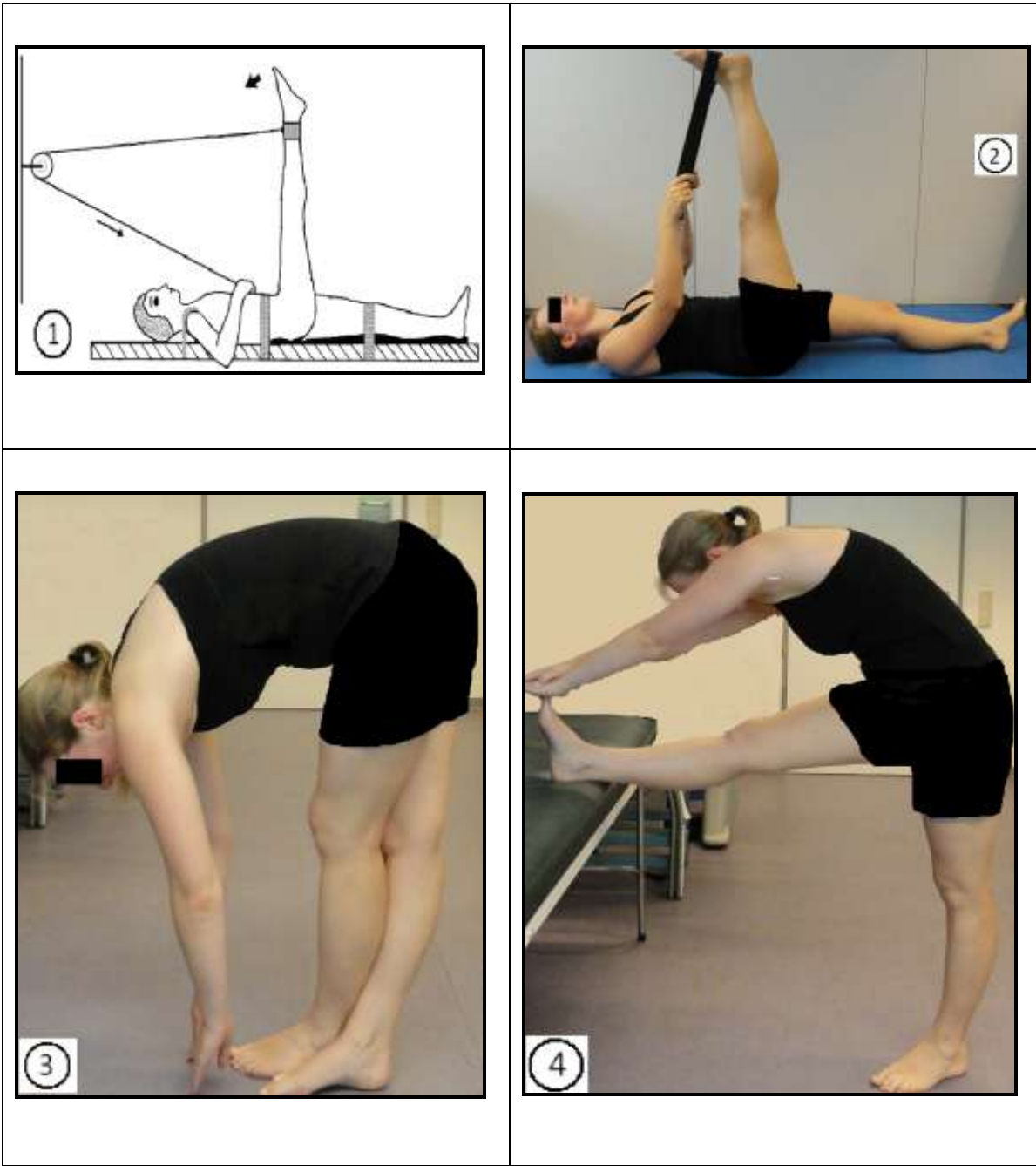

Fig. 2: Stretching exercises of the first study

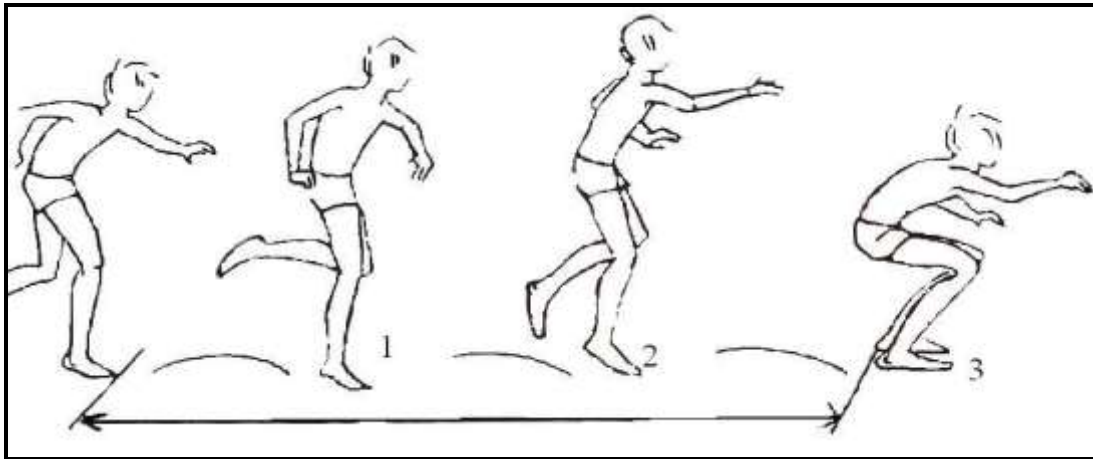

Fig. 3: triple-hop test in the second study (from Fetz & Kornexl, 1993, p. 26)

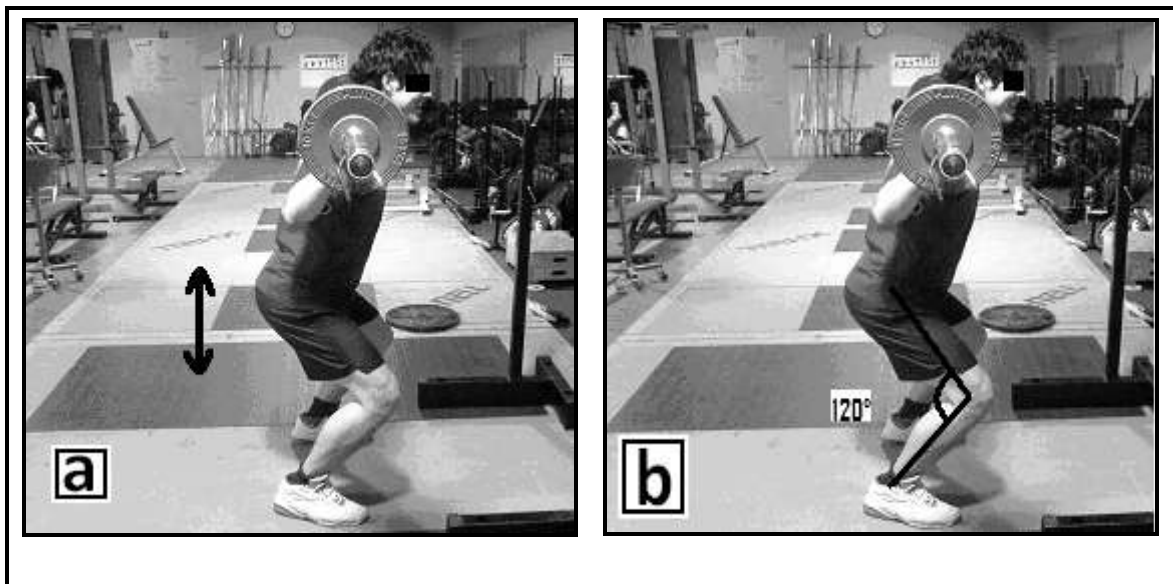

Fig. 4: Dynamic half squat exercise (a) and isometric squat exercise (b) in the second study

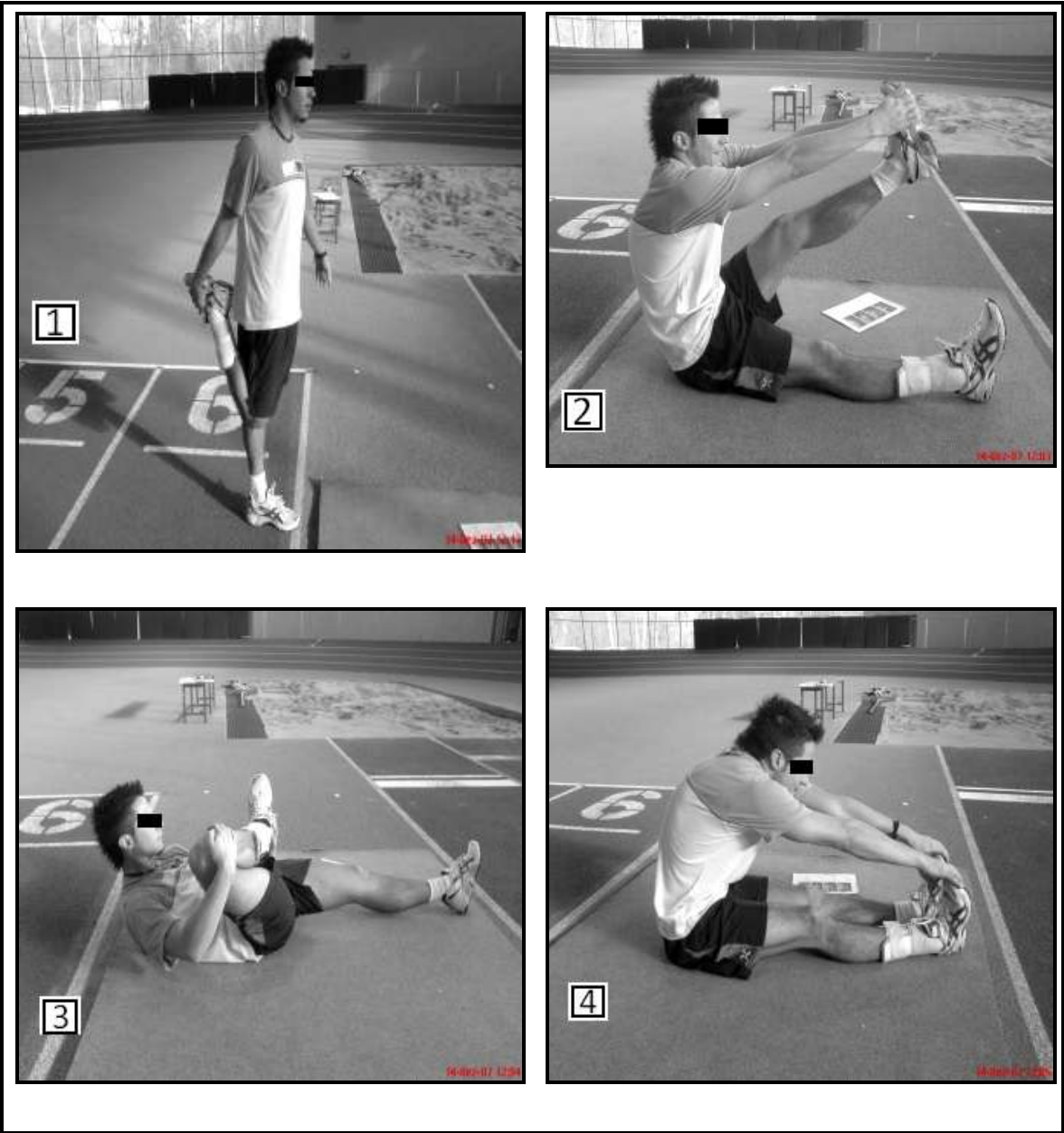

Fig. 5: Stretching exercises of the second study

%1RM	Number of repetitions allowed
100	1
95	2
93	3
90	4
87	5
85	6
83	7
80	8
77	9
75	10
70	11
67	12
65	15

Fig. 6: Percent of the 1-RM and repetitions allowed (adapted from Baechle et al., 2008. p. 394)

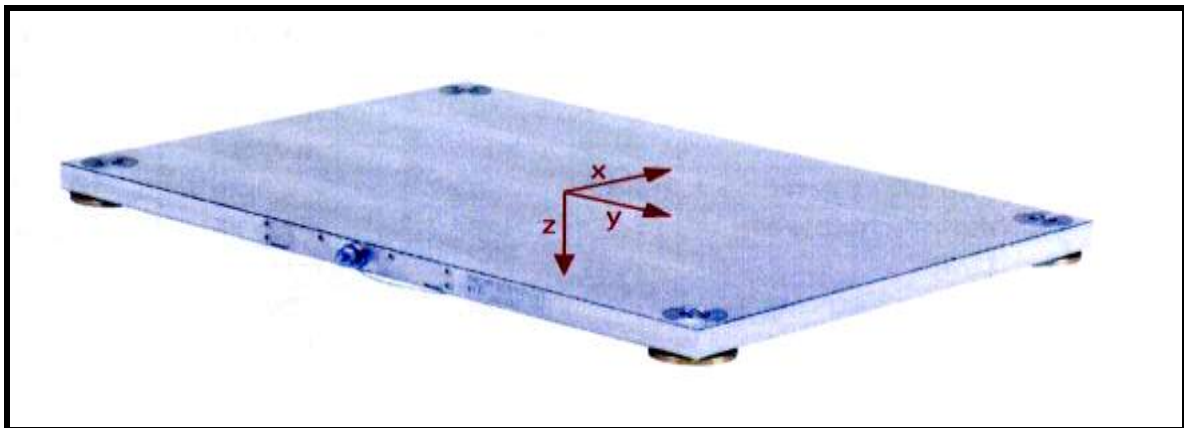

Fig. 7: Mobile Kistler force plate type 9286B

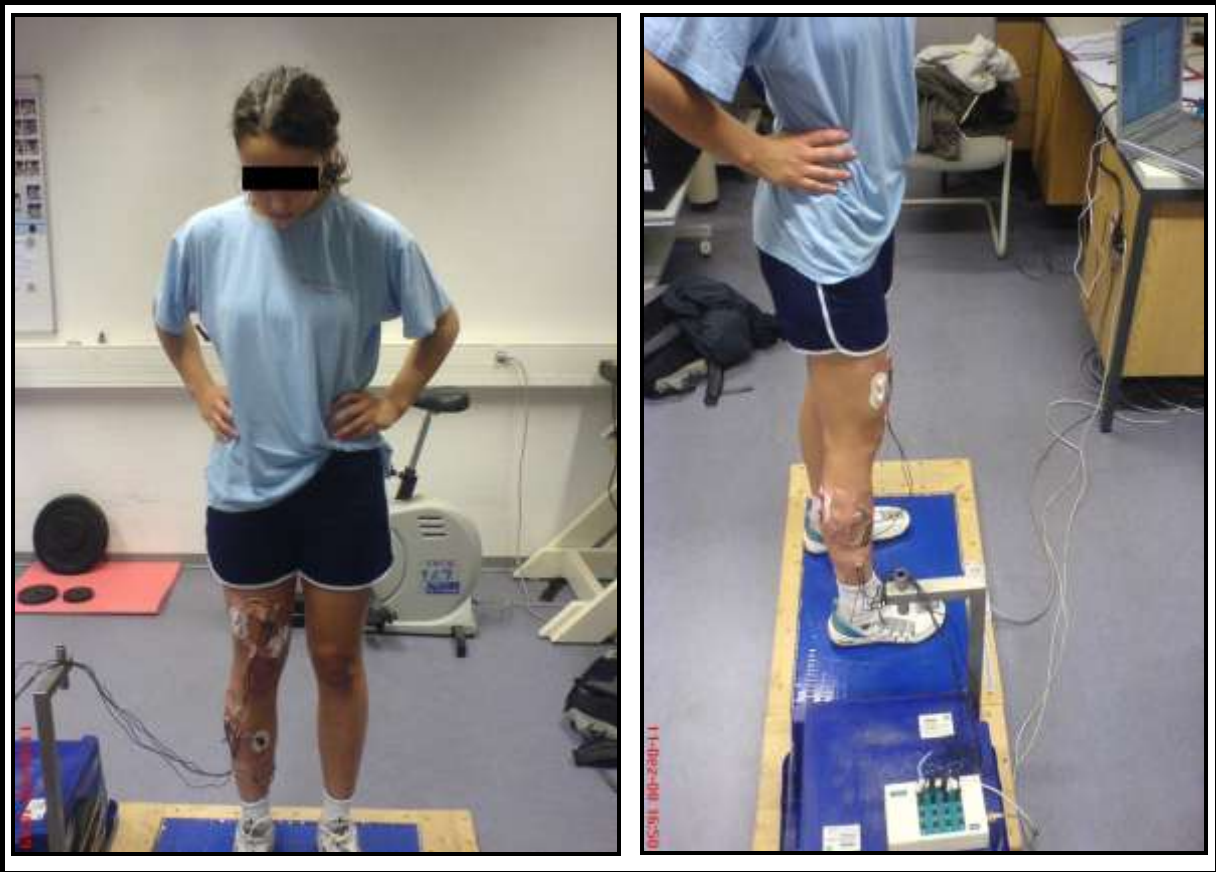

Fig. 8: Measurements of the third study

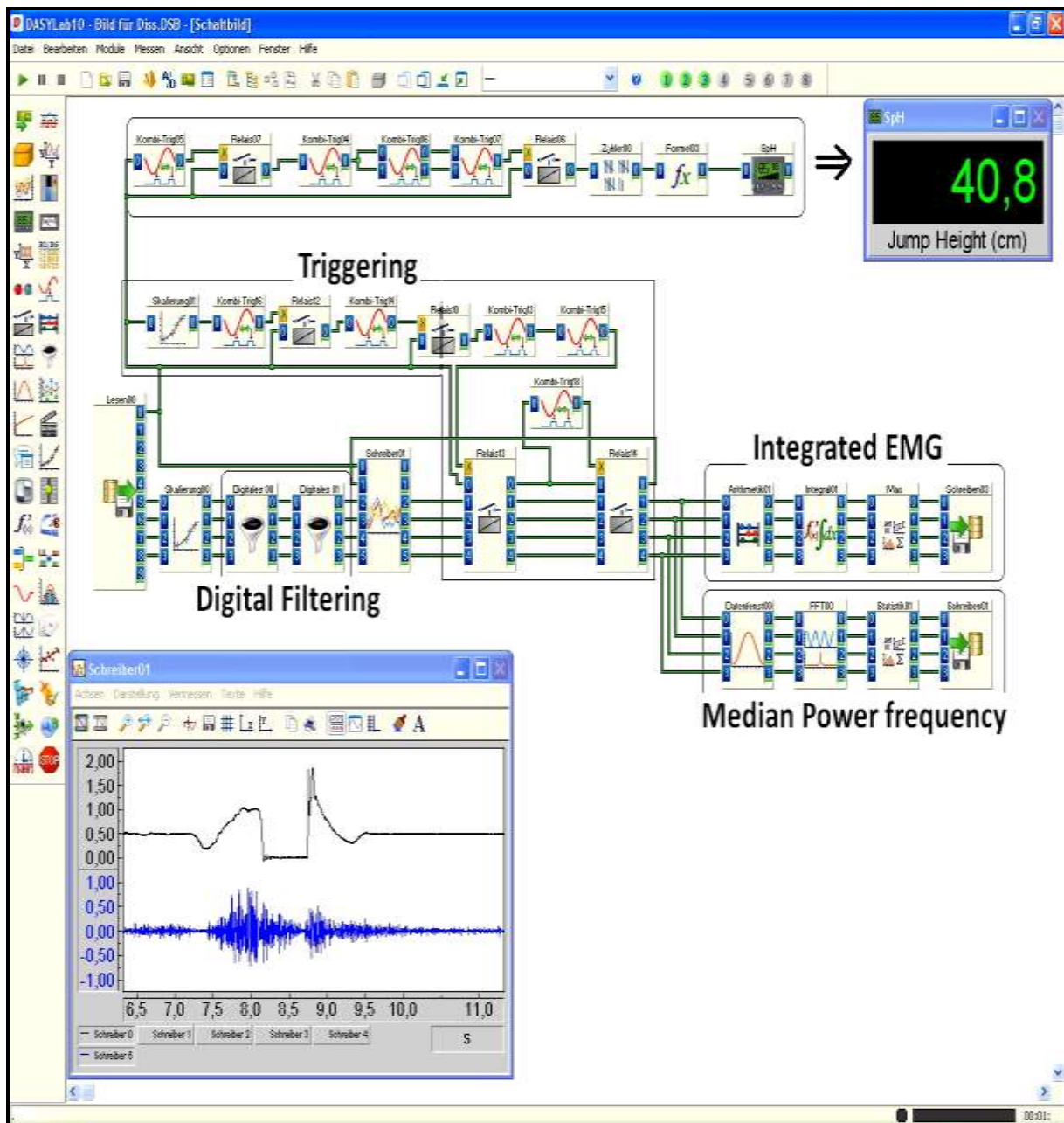

Fig. 9: The data-reading (processing) worksheet as it was shown in DASYLab in the third study

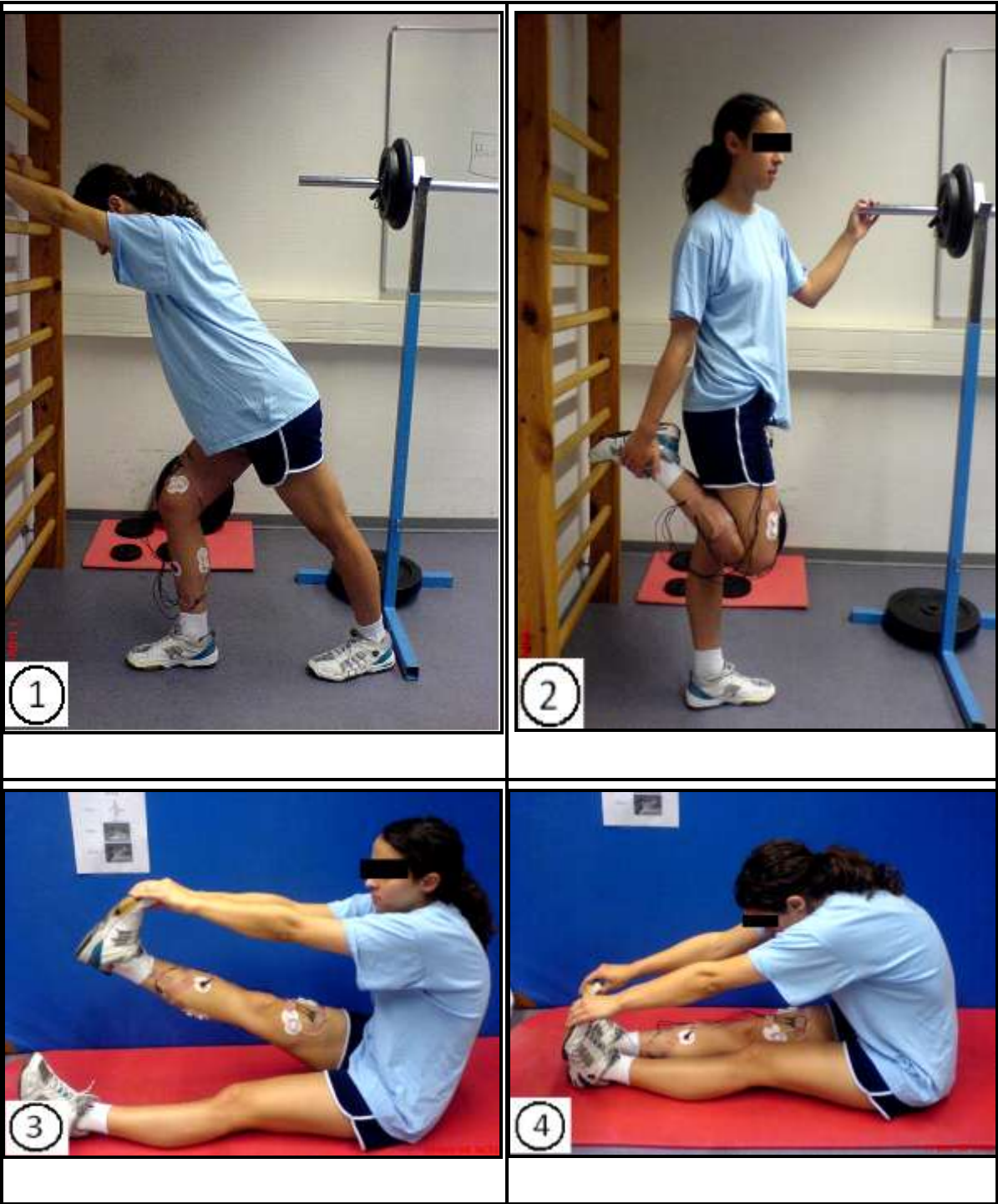

Fig. 10: Stretching exercises of the third study.



Fig. 11: Weighted jumps at 30 % of one's 1-RM in the third study