



UNIVERSITÄT  
DES  
SAARLANDES

UNIVERSITÄT DES SAARLANDES  
FAKULTÄT HW  
BEREICH EMPIRISCHE HUMANWISSENSCHAFTEN

**MOSAIC**

**Modelling and Training of Self-Regulated Learning and Analysis  
of Individual Differences in College Students**

Dissertation  
zur Erlangung des akademischen Grades eines  
Doktors der Philosophie  
der Fakultät HW  
Bereich Empirische Humanwissenschaften  
der Universität des Saarlandes

vorgelegt von  
Laura Dörrenbächer  
aus Ottweiler

Saarbrücken, 2017

Der Dekan: Prof. Dr. Cornelius König

Berichtersteller/innen:

Prof. Dr. Franziska Perels, Universität des Saarlandes

Prof. Dr. Julia Karbach, Goethe-Universität Frankfurt

Prof. Dr. Robin Stark, Universität des Saarlandes

Tag der Disputation: 09.01.2017

*„Ich kann, weil ich will, was ich muss.“*

Immanuel Kant (1724-1804)

## **Acknowledgements**

First of all, I would like to express my thankfulness to my advisor, Prof. Dr. Franziska Perels. When I joined her working group in 2010 as a student assistant working on my Bachelor thesis on self-regulated learning, I did not think that I would accomplish my doctoral thesis six years later on this topic as well. Her expertise and commitment to applied research in educational context convinced me of the topic's relevance and strengthened my interest in self-regulated learning. Moreover, I am grateful for her excellent supervision combined with nearly unlimited availability during all this time. In addition to this, I would specially like to thank her for the freedom she afforded me with concerning my research question and the thesis' conduction.

My very special thanks go to my current and past colleagues Dr. Manuela Leidinger, Dr. Daniela Wagner, Katrin Philippi, Lisa Dörr, Laura Venitz, and Angelika Schmitt for providing a very pleasant and comfortable working climate. On-topic and off-topic conversations as well as dinners or conference visits resulted in a lot of memorable moments that I will often look back on in the future.

I would like to express my dedication to all student assistants that supported me during the project. In particular, I would like to thank Isabella Hart for her assistance conducting the student trainings as her blithesome mind and her well-organized working habit made it much easier to handle frustrations.

I would like to thank the graduate program of Saarland University "GradUS" for receiving a PhD scholarship that helped me finance two years of my thesis period.

A very special word of thanks goes to my parents, Hildegard and Theo Dörrenbächer, and my boyfriend, Chino Ulrich, as these are the most important

people in my life. They always supported me in what I was doing and provided me with the self-esteem needed to handle throwbacks. Even in their hardest times, my parents cared for me. It is so important to know that you have people you always can rely on and who are always there for you. Having such a “team” behind you that acts as an anchor throughout all situations is irreplaceable and means more to me than words can say.

## Table of Contents

<b>Acknowledgements</b> .....	<b>IV</b>
<b>List of Figures</b> .....	<b>VIII</b>
<b>List of Tables</b> .....	<b>IX</b>
<b>List of Abbreviations</b> .....	<b>X</b>
<b>List of Publications</b> .....	<b>XI</b>
<b>Summary</b> .....	<b>XII</b>
<b>Zusammenfassung</b> .....	<b>XV</b>
<b>1 Introduction</b> .....	<b>18</b>
<b>2 Theoretical and Empirical Framework</b> .....	<b>22</b>
2.1 Self-Regulation.....	22
2.1.1 Process Model of Self-Regulation .....	24
2.1.2 Development of Self-Regulation .....	28
2.2 Self-Regulated Learning.....	30
2.2.1 Definition and Components of Self-Regulated Learning.....	30
2.2.2 Models of Self-Regulated Learning .....	32
2.2.3 Individual Differences in Self-Regulated Learning .....	40
2.3 Fostering Self-Regulated Learning .....	42
2.3.1 Trainings .....	44
2.3.2 Fostering SRL through self-monitoring.....	46
2.3.3 Aptitude-Treatment-Interactions.....	50
<b>3 Research Aims</b> .....	<b>53</b>
3.1 Aim 1 .....	54
3.2 Aim 2 .....	55
3.3 Aim 3 .....	56
<b>4 Methodological Issues</b> .....	<b>57</b>
4.1 Study I .....	57
4.2 Study II.....	60
4.3 Study III.....	63
<b>5 Overview of Studies</b> .....	<b>65</b>
5.1 Study I .....	66
5.1.1 Theoretical background and aims .....	67
5.1.2 Methods.....	69
5.1.3 Results .....	70
5.1.4 Discussion .....	71

5.2	Study II.....	73
5.2.1	Theoretical background and aims .....	73
5.2.2	Methods.....	75
5.2.3	Results.....	77
5.2.4	Discussion .....	78
5.3	Study III.....	79
5.3.1	Theoretical background and aims .....	80
5.3.2	Methods.....	81
5.3.3	Results.....	82
5.3.4	Discussion .....	83
<b>6</b>	<b>General Discussion.....</b>	<b>85</b>
6.1	Discussion of Findings .....	85
6.1.1	Trait-Model for Self-Regulated Learning .....	85
6.1.2	Fostering Self-Regulated Learning in College.....	87
6.1.3	Individual Differences in Self-Regulated Learning.....	89
6.2	Limitations.....	92
6.2.1	Study Design .....	93
6.2.2	Assessment Methods.....	95
6.3	Future Research Directions .....	99
6.3.1	SRL Trait Model and its Transfer to State Level.....	99
6.3.2	Training Methods for Self-Regulated Learning.....	103
6.3.3	Adaptive Trainings.....	105
6.3.4	Assessment Methods.....	102
6.4	Practical Implications .....	106
<b>7</b>	<b>References .....</b>	<b>108</b>

### List of Figures

<i>Figure 1.</i> Triadic model of self-regulation (adapted from Zimmerman, 1989)....	23
<i>Figure 2.</i> Social-cognitive process model of self-regulation (adapted from Zimmerman, 2000).....	25
<i>Figure 3.</i> Three-layer model of self-regulated learning (adapted from Boekaerts, 1999). .....	33
<i>Figure 4.</i> State model of self-regulated learning (Schmitz & Wiese, 2006).....	35
<i>Figure 5.</i> Trait model of self-regulated learning (Hong & O’Neil, 2001).....	37
<i>Figure 6.</i> State-trait conception of SRL (see Schmitz, Landmann, & Perels, 2007, p. 321). .....	38
<i>Figure 7.</i> Integrative state-trait model of self-regulated learning (Schmidt, 2009) .....	39
<i>Figure 9.</i> Trait model of self-regulated learning (Dörrenbächer & Perels, 2015).. .....	71
<i>Figure 10.</i> Integrative trait-state model of SRL.....	101
<i>Figure 11.</i> Hypothetical influence of trait SRL on state SRL. ....	102



**List of Tables**

Table 1. Developmental Levels of Regulatory Competence (Zimmerman, 2000) .....	29
Table 2. Fit indices and their cut-offs for acceptable model fit.....	59

**List of Abbreviations**

ANCOVA	analysis of covariance
ANOVA	analysis of variance
BIC	Bayesian information criterion
CFA	confirmatory factor analysis
CFI	comparative fit index
CG	control group
df	degrees of freedom
FIML	full information maximum likelihood
GPA	grade point average
LCA	latent class analysis
LG	learning diary group
LMRT	Lo-Mendell-Rubin test
LPA	latent profile analysis
M	mean
ML	maximum likelihood
MLR	robust maximum likelihood estimator
RMSEA	root mean square error of approximation
SD	standard deviation
SEM	structural equation modelling
SPSS	Statistical Package of the Social Sciences
SRL	self-regulated learning
SRMR	standardized root mean square residual
TG	training group
LTG	combination group (training + learning diary)

### List of Publications

The present dissertation is based on three articles that are published in peer-reviewed journals. Full articles can be found in the appendix of this dissertation and are available online through the respective publishing company.

1. Dörrenbächer, L. & Perels, F. (2015). Volition completes the puzzle: Development and evaluation of an integrative trait model of self-regulated learning. *Frontline Learning Research*, 3(4), 14-36. <http://dx.doi.org/10.14786/flr.v3i4.179>
2. Dörrenbächer, L. & Perels, F. (2016). More is more? Evaluation of Interventions to Foster Self-Regulated Learning in College. *International Journal of Educational Research*, 78, 50-65. <http://dx.doi.org/10.1016/j.ijer.2016.05.010>
3. Dörrenbächer, L. & Perels, F. (in press). Self-regulated learning profiles in college students: Their relation to achievement, personality, and the effectiveness of an intervention to foster self-regulated learning. *Learning and Individual Differences*. <http://dx.doi.org/10.1016/j.lindif.2016.09.015>

## Summary

Self-regulated learning (SRL) is defined as processes during which learners activate and sustain cognitions, affects, and behaviors that systematically support the attainment of personal goals. Therefore, this construct presents a necessary prerequisite for lifelong learning. As college students undergo a critical transition when entering the autonomous college environment, they need abilities to embrace self-managed and self-directed learning, which is why SRL is seen as highly important for successful postsecondary education. As this relevance is emphasized by the positive relationship of SRL to achievement, the present thesis aims to model and foster SRL in college students with including a differential perspective. To achieve this, three separate studies were conducted.

To model SRL theoretically, study I investigated the construct's structure in college students by developing and evaluating an integrative SRL trait model. Although most authors agree that the construct embraces cognitive, metacognitive, and motivational components, there are arguments for integrating volitional aspects within SRL frameworks. As this assumption is rarely examined empirically, a new conceptualization for volition within learning environments was developed. Results show that future time perspective, academic delay of gratification, and procrastination are useful to represent volition for learning environments. Moreover, the results of the study are in favor of integrating volitional components into structural models of SRL, and these volitional aspects are part of a broader motivational factor that also encompasses motivational beliefs.

As college students often show deficits in the knowledge and application of SRL strategies, study II aimed to gain new insight into how to foster SRL most effectively in this target group. Besides trainings that impart strategy knowledge

and practice, standardized learning diaries have proved useful to foster college students' SRL. As there are ambiguous findings about the effectiveness of learning diaries without further SRL intervention and about their usefulness to increase training effects, study II investigated which method best fosters SRL in college students most and if a combination of both results in higher effects. The findings of the study show that content-independent SRL training can significantly increase college students' SRL and that this increase is even higher when training is combined with standardized learning diaries. The sole application of learning diaries has no effects on students' SRL, hypothesizing that they need a theoretical framework to benefit from instructional self-monitoring.

Aside from its general importance, there seem to be individual differences in SRL. On the one hand, SRL is related to academic achievement, with high achieving students using more SRL strategies than low achieving students. On the other hand, personality factors seem to vary with different levels of SRL as highly self-regulated learners are more likely to be conscientious and extraverted and show less neuroticism. As these individual differences have rarely been investigated within a theoretical framework, study III aimed to examine the differences in SRL and to analyze their relation to achievement and personality as well as their influence on the effectiveness of an SRL intervention. The results speak in favor of four SRL profiles that differ quantitatively and qualitatively, with the more skilled profiles showing higher achievement and well-adjusted personality characteristics. Moreover, only moderate and motivated students seem to benefit from the SRL training conducted, whereas low and high SRL students would need interventions tailored specifically to their needs.

In conclusion, the present thesis gives new insights into the theoretical structure of SRL and provides suggestions to foster this competence in college students. Moreover, the results can be used to adapt SRL interventions to specific needs of different learner groups and to provide college students with optimal learning environments.

## **Zusammenfassung**

Selbstreguliertes Lernen (SRL) wird definiert als Prozess, während dem der Lernende Kognitionen, Emotionen und Verhaltensweisen, die die Erreichung persönlicher Ziele systematisch unterstützen, aktiviert und aufrechterhält. Basierend auf dieser Konzeptualisierung wird das Konstrukt als Voraussetzung lebenslangen Lernens angesehen. Da Studierende sich beim Eintritt in das autonom gestaltete Universitätsleben in einer kritischen Übergangsphase befinden und verstärkt Fähigkeiten des Selbstmanagements bedürfen, wird SRL als wichtiger Faktor für erfolgreiches Lernen dieser Zielgruppe angesehen. Da diese Annahme durch den positiven Zusammenhang zwischen SRL und Leistung unterstrichen wird, zielt die vorliegende Dissertation auf die Modellierung und Förderung der Kompetenz unter Einbezug einer individuellen Perspektive bei Studierenden ab. Zu diesem Zweck werden die Ergebnisse dreier separater Studien berichtet.

Um die Struktur des Konstrukts bei Studierenden zu untersuchen und theoretisch zu modellieren, wurde in Studie I ein integratives SRL Trait-Modell entwickelt und evaluiert. Obwohl die meisten Autoren dahingehend übereinstimmen, dass SRL kognitive, metakognitive und motivationale Komponenten umfasst, gibt es Argumente für die Integration volitionaler Aspekte innerhalb von SRL-Modellen. Um diese Annahme empirisch zu überprüfen, wurde in einem ersten Schritt eine neue Konzeptualisierung volitionaler Aspekte für Lernsituationen entwickelt, die die Variablen Zukunftsorientierung, akademischer Belohnungsaufschub und Prokrastination umfasst. Die Ergebnisse der Studie sprechen für die Integration dieser volitionalen Komponenten in Strukturmodelle selbstregulierten Lernens und dafür, dass volitionale Aspekte Teil

eines breiteren Motivationsfaktor sind, der auch motivationale Überzeugungen umfasst.

Da Studierende oft Defizite im Wissen und der Anwendung von SRL-Strategien zeigen, wurde in Studie II untersucht, welche SRL-Interventionen in dieser Zielgruppe die höchste Wirkung zeigen. Neben Trainings, die Strategiewissen und -übung vermitteln, haben sich standardisierte Lerntagebücher als wirksam erwiesen, um SRL bei Studierenden zu fördern. Da die Ergebnislage bezüglich der Effektivität von Lerntagebüchern ohne weitere SRL-Intervention und in Bezug auf deren Nützlichkeit zur Erhöhung von Trainingseffekten nicht eindeutig ist, wurde weiterhin analysiert, welche der Methoden SRL bei Studierenden am effektivsten fördern kann und ob eine Kombination beider Methoden in höheren Effekten resultiert. Die Ergebnisse der Studie zeigen, dass ein fachunabhängiges SRL-Training in einer signifikanten SRL-Zunahme resultiert und dass dieser Zuwachs höher ist, wenn das Training mit standardisierten Lerntagebüchern kombiniert wird. Die alleinige Anwendung von Lerntagebüchern zeigt hingegen keinen Effekt, weshalb angenommen werden kann, dass die Studierenden einen theoretischen Rahmen brauchen, um von instruktioneller Selbstbeobachtung profitieren zu können.

Trotz der generellen Relevanz von SRL für Studierende scheinen individuelle Unterschiede bezogen auf die Kompetenzausprägung zu bestehen. Einerseits zeigt SRL Zusammenhänge mit akademischer Leistung, da höher leistende Studierende mehr SLR-Strategien nutzen als niedrileistende Studierende. Andererseits scheinen Persönlichkeitsfaktoren mit der Ausprägung von SRL zu variieren, denn hoch selbstregulierte Lerner sind eher gewissenhaft und extravertiert und zeigen geringere Neurotizismuswerte als niedrig



selbstregulierte Lerner. Da diese differentiellen Aspekte bisher selten unter Nutzung eines theoretischen Rahmens untersucht wurden, zielte Studie III auf die Analyse individueller SRL-Unterschiede unter Anwendung von Profilanalysen. Diese Unterschiede wurden dann im Hinblick auf ihren Zusammenhang mit Leistung und Persönlichkeit analysiert und es wurde untersucht, ob sie die Effektivität einer SRL-Intervention beeinflussen. Die Ergebnisse sprechen für die Existenz von vier SRL-Profilen, die sich quantitativ und qualitativ unterscheiden, wobei die Profile mit höheren SRL-Ausprägungen mit höherer Leistung und einem besser angepassten Persönlichkeitsprofil einhergehen. Darüber hinaus profitieren nur Studierende mit moderaten SRL-Fähigkeiten und Studierende mit besonders hoher Motivation von einem SRL-Training, wohingegen Studierenden mit geringen und hohen SRL-Ausprägung Interventionen bedürfen, die spezifisch auf ihre Bedürfnisse angepasst sind.

Zusammengefasst gibt die vorliegende Dissertation neue Einblicke in die theoretische Struktur des SRL und liefert Hinweise, wie diese Kompetenz bei Studierenden am effektivsten gefördert werden kann. Darüber hinaus können die Ergebnisse dazu genutzt werden, SRL-Interventionen auf die spezifischen Bedürfnisse verschiedener Lernergruppen zuzuschneiden und Studierende mit optimalen Lernumgebungen zu versorgen.

# 1 Introduction

Today's society is characterized by technology innovations and an increasing amount of available information. Knowledge is transferred with high speed and can be accessed all around the globe, which is why some authors have named the current century the "knowledge age" (Bereiter, 2002). In order to cope with the demands resulting from this kind of society, it is necessary that individuals are educated to become lifelong learners. They need to acquire knowledge self-directed without external support. The competence that "refers to processes whereby learners personally activate and sustain cognition, affects, and behaviors that are systematically oriented toward the attainment of personal goals" (Zimmerman & Schunk, 2011, p. 1) is subsumed under the term self-regulated learning (hereafter referred to as SRL). SRL comprises the self-directed acquisition of knowledge, the adaptive use of knowledge, and the continuous actualization of knowledge (Bronson, 2000), which is why several authors see SRL as a prerequisite for lifelong learning (Lüftenegger et al., 2012).

According to Weinert (2001, p. 27) competences are defined as existing or learnable abilities to solve specific problems and the accompanying motivational, volitional, and social willingness to use these abilities successfully and responsibly in different situations. As SRL is regarded as a trainable competence (e.g., Dignath, Büttner, & Langfeldt, 2008) and can be used to solve different learning problems (Wirth & Leutner, 2008), the construct meets the requirements of this definition in all points and therefore is seen as a cross-curricular competence (Wirth & Leutner, 2008). It is, moreover, seen as a key competence for lifelong learning as it enables students to actively engage in learning processes (EU Council, 2002). In line with this, SRL is part of the quality indicators of educational systems as assessed in PISA (Programme for International Student Assessment; Baumert et al., 2001). Moreover, results of external evaluations of the German educational system have revealed the importance of cross-

curricular learning competences such as SRL and hint at the necessity to foster this competence (Prenzel et al., 2004).

The relevance of SRL to educational systems is underpinned by several findings that show the construct's impact on achievement. As these findings stem from different learning environments that cover the entire educational process (primary school: Dignath, Büttner, & Langfeldt, 2008; Throndsen, 2011; secondary school: Perels, Gürtler, & Schmitz, 2005; Perels, Dignath, & Schmitz, 2009; college: Kitsanastas, Winsler, & Huie, 2008; Nandagopal & Ericsson, 2012, and professional settings: Sitzman & Ely, 2011), they highlight the importance of SRL for lifelong learning (Wirth & Leutner, 2008). Besides academic outcomes, SRL has emotional correlates as it has a positive impact on well-being (Park, Edmondson, & Lee, 2012) and a negative influence on test anxiety (Kesici, Baloglu, & Denis, 2011) and therefore is meaningful for broader learning relevant variables as well.

As college students undergo a critical transition when leaving school and entering the autonomous college environment, they are in special need of abilities to cope with the demands of self-managing and self-directed learning (Viebahn, 1990). The incorporation of a high amount of freedom concerning time- and content-management with severe standards resulting from the Bologna reform promote stress and student burnout (Imhof & Bachmann, 2007). In accordance, Blüthmann (2012) presents learning strategies and learning motivation as central factors for successful college learning that can also act as protection against college dropouts (Blüthmann, Thiel, & Wolfgram, 2011). Although the construct of SRL in general has a high relevance for college student learning, time management strategies (Kitsanastas, Winsler, & Huie, 2008), elaboration strategies (Tynjälä, Salminen, Sutela, Nuutinen, & Pitkänen, 2005), and self-efficacy (DiBenedetto & Bembenuddy, 2011; Richardson, Abraham, & Bond, 2012) seem to have special importance for academic success. In addition, a recent meta-analysis (Sitzman & Ely, 2011) underlines the importance of metacognitive strategies,

motivation, attribution, goal-setting, and self-efficacy for successful learning processes. In line with this variance of empirically relevant SRL strategies, most authors agree that the construct theoretically embraces cognitive, metacognitive, and motivational components (e.g., Boekaerts, 1999). Nevertheless, several authors argue for a stronger integration of volitional aspects within SRL frameworks (e.g., Corno, 2001), as these also have an influence on academic achievement of college students (Duckworth, Gendler, & Gross, 2014). To date, there is only one study investigating the empirical structure of SRL in college students (Hong & O'Neil, 2001). As this study has several limitations and does not integrate a volitional component, it would be necessary to develop and examine a structural model of SRL for college students that integrates all the abovementioned components and considers the demand for including volitional aspects (Study I).

Although SRL is seen as a highly important factor for successful postsecondary education in general (Bembenutty, 2011b), college students often show deficits in the knowledge and application of SRL strategies (Bembenutty, 2011b) and tend to overestimate their competences, which can lead to underachievement due to missing regulatory behavior (Dunlosky & Rawson, 2012; Koriat & Bjork, 2006). This finding hints at an inadequate calibration and at missing SRL (especially metacognitive) competencies (Cohen, 2012; Hadwin & Webster, 2013; Peverly, Brobst, Graham, & Shaw, 2003), which is why college students have a special need for SRL support. Despite this relevance, opportunities to improve cross-curricular competences such as SRL are rarely institutionalized in German universities (Paetz, Ceylan, Fiehn, Schworm & Harteis, 2011). Because of this and the construct's relevance, it is important to gain new insight into how to foster SRL most effectively in college students. In this context, trainings that impart strategy knowledge have proved useful to foster college students' SRL (Reeves & Stich, 2011). Besides that, standardized learning diaries can be used to increase students' self-monitoring and therefore help support SRL (Dignath-van Ewijk, Fabriz, & Büttner, 2015). As there are ambiguous findings concerning

the effectiveness of learning diaries without further SRL intervention and concerning their usefulness to increase strategy effects (Fabrizz, Dignath-van Ewijk, Poarch, & Büttner, 2014), it would be desirable to investigate which method fosters SRL in college students most effectively (Study II).

As mentioned above, several studies speak in favor of SRL's positive influence on college students' academic achievements (e.g., Nandagopal & Ericsson, 2012; Kitsantas, 2002; Valle et al., 2008; Zhu, Au, & Yates, 2016). Besides achievement, personality factors seem to vary with different levels of SRL (Bidjerano & Dai, 2007): Highly self-regulated learners are more likely to be conscientious and extraverted and show less neuroticism. As these individual differences have rarely been investigated within a theoretical framework of SRL, studies that examine differences in SRL and analyze their relation to achievement and personality seem necessary. Based on this person-centered framework, it should moreover be analyzed how such individual differences influence the effectiveness of SRL interventions (Study III). Using these findings would help tailor SRL interventions to specific needs of different learner groups and provide college students with optimal learning environments.

In conclusion, the present thesis focuses on modeling and fostering SRL in college students and has several aims: The first study will investigate the structure of SRL in college students by modeling the relationship of cognitive, metacognitive, motivational, and volitional components to design an integrative trait model of SRL. This research question, which is theoretical in nature, becomes practically relevant when theoretical models are used as guidelines to develop successful interventions. Therefore, the second study will analyze the effectiveness of different SRL interventions that incorporate the components of the trait model (training, learning diary, combination of both methods) and aimed to answer the question of how SRL can be fostered most effectively in college. As intervention effectiveness can vary with subgroups of students, the third study will investigate if there are distinct SRL profiles in college students and if these are related to achievement level and

personality. The study will also examine how SRL intervention effects vary with regard to these profiles. To theoretically ground these research questions, the subsequent section will give an overview on the definition, theories, models, and research findings that were used to generate this dissertation's aims.

## 2 Theoretical and Empirical Framework

This first section summarizes the theoretical and empirical framework that this thesis is based on. It will therefore describe theoretical models and components of self-regulation and SRL as well as the results regarding individual differences in SRL. Furthermore, different ways to foster SRL are depicted and discussed with regard to their empirical effectiveness. In addition, findings about the impact of individual differences on intervention effectiveness are recapped. Moreover, methodological issues that had to be considered in the studies are presented in a separate section. The second section gives an overview of the three studies this thesis is based on. The last section reconsiders the central findings of these studies with regard to results of previous research and critically discusses the limitations of the studies as well as future research aims.

### 2.1 Self-Regulation

According to Zimmerman (2000), self-regulation is defined as “self-generated thoughts, feelings, and actions that are planned and cyclically adapted to the attainment of personal goals” (p. 14). This definition has several parts that indicate the central components of the construct: Self-regulation is *self-generated*, which means the individual has to direct and manage his or her own cognitions, emotions, and behavior. It is also *planned and cyclically adapted*, which indicates a process view: Feedback stemming from preceding actions is inevitable to adapt to changing environmental features and to optimize suboptimal strategy

use. Lastly, the definition clarifies the role of personal goals as only *goal-directed* actions can be subject to self-regulation.

Zimmerman (2000) emphasizes that his definition is based on the social-cognitive perspective (Bandura, 1986) that considers the interaction of personal, behavioral, and environmental processes. As these three factors are unstable, different feedback loops help the individual to pursue goal-directed actions through self-observation (see Figure 1). Behavioral and environmental self-regulation involves the adaption of strategy use or changes in environmental circumstances. Besides these observable adjustments, changes in cognitive and affective states constitute the process of covert self-regulation. Observable as well as covert adaption is especially effective if the triadic factors (person, behavior, and environment) are monitored accurately and constantly. As feedback loops are modeled as open loops, adjustments can be made reactively (reducing performance discrepancies; Locke, 1991) as well as proactively (increasing performance discrepancies for self-challenging goals). The following section aims to describe how self-regulatory competence develops and indicates that each skill can be executed in a self-regulatory way.

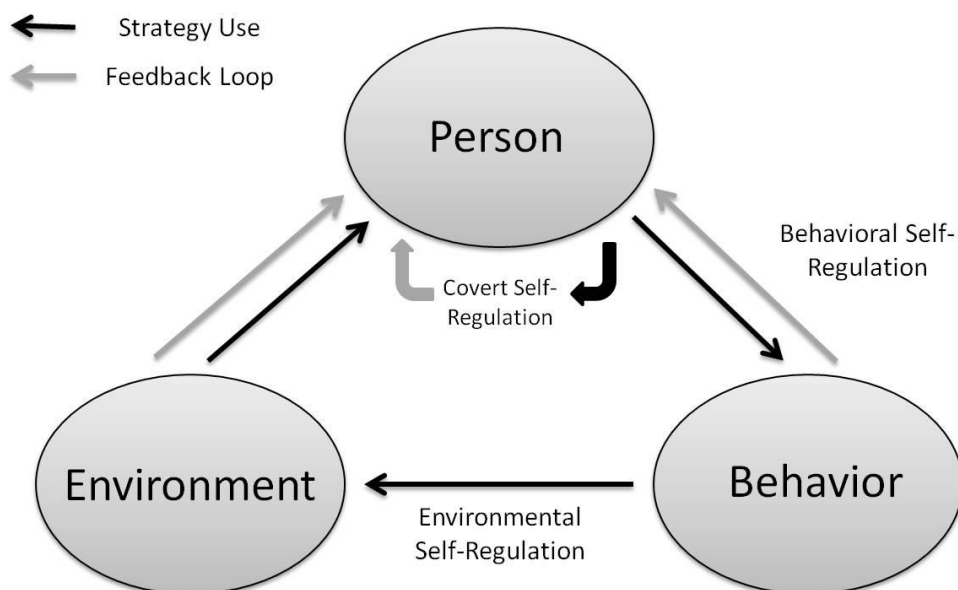

Figure 1. Triadic model of self-regulation (adapted from Zimmerman, 1989).

### 2.1.1 Process Model of Self-Regulation

Although there are different models to explain self-regulation (e.g., Carver & Scheier, 2000; Kuhl, 2000), this thesis is based on the social-cognitive process model of self-regulation (Zimmerman, 2000) for several reasons: First, this model can be applied to different research areas (e.g., sports, health behavior, and learning; Landmann, Perels, Otto, & Schmitz, 2009) and thus is not context-bound in itself. Second, the model is designed within the social-cognitive framework (Bandura, 1986) and focuses on the interaction of personal, behavioral and environmental factors. Therefore, self-regulation is not seen as unchangeable but as a cyclical process that is directed to goal achievement, which is why the model offers many starting points when developing interventions to foster this competence. Third, as process models focus on adaptive behavior in response to changing environmental conditions, they are appropriate to describe and analyze individual differences in SRL (Schmidt, 2009).

Zimmerman (2000) emphasizes that feedback stemming from preceding actions is absolutely essential to act goal-directed and to adapt to changing conditions in personal, behavioral or environmental factors. In general, cyclical self-regulation follows the principles of the cybernetic model (Wiener, 1948): The current state is continuously compared to a target state through feedback loops. Feedback information allows for regulating actions to reduce discrepancies of both states. The individual runs through this process as long as he or she has not yet achieved a goal, which is why it can be seen as cyclical. Zimmerman (2000) describes three phases that constitute a self-regulation cycle: forethought phase, performance phase, and reflection phase (Figure 2). Each phase encompasses several subcomponents that are essential to self-regulated acting.



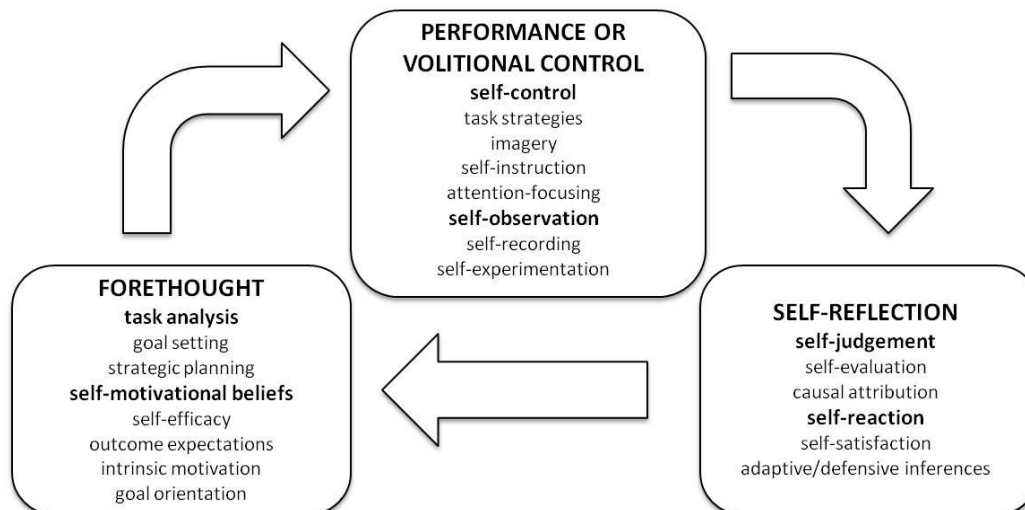

Figure 2. Social-cognitive process model of self-regulation (adapted from Zimmerman, 2000).

The *forethought phase* is constituted by task analysis processes and self-motivation beliefs. *Goal setting*<sup>1</sup> is the first component of task analysis and represents the basis for self-regulated behavior. Hierarchical goal systems are especially useful, as proximal subgoals help structure more distal goals and lead to earlier feelings of success that help motivate the individual (Locke & Latham, 1990). Besides goal setting, *strategic planning* is a part of task analysis (Weinstein & Mayer, 1986). It is evident that task-appropriate strategies help enhance performance by supporting cognition and emotions (Pressley & Woloshyn, 1995). Strategic planning is interindividually different and involves strategy adaption in reaction to changing personal, behavioural, and environmental conditions. Moreover, with increasing competences, strategies can lose their effectiveness and have to be substituted by more effective ones.

In order to use these planned strategies, an individual has to motivate himself or herself to initiate the actual performance of the task. One essential self-motivational belief is *self-efficacy* (Bandura, 1997), which is defined as “personal beliefs about having the means to learn or perform effectively” (Zimmerman, 2000, p. 17). It therefore does not refer to actual competence but to beliefs about having the necessary competence. Self-efficacy has been

<sup>1</sup> Some model components are typed in italics as they were used in the three studies to model and to foster SRL in college students.

shown to influence the use of academic learning strategies (Fadlelmula, Cakiroglu, & Sungur, 2015; Zimmerman, Bandura, & Martinez-Pons, 1992), academic time management (Britton & Tessor, 1991; Kandemir, Ilhan, Ozpolat, & Palanci, 2014), self-monitoring (Bouffard-Bouchard, Parent, & Larivee, 1991), and goal setting (Zimmerman & Bandura, 1994), which is why it is a central motivational belief. Self-efficacious individuals choose more challenging goals (Barnard-Brak, Lan & Osland Paton, 2010) that positively influence self-motivation if they are attained (Zimmerman & Kitsantas, 1997). In addition to self-efficacy, outcome expectations concerning the long-term consequences of an action are an important self-motivational belief (Pajares, 2008). Moreover, individuals should be *intrinsically motivated* by the performance of the action itself and not solely by its consequences (Deci & Ryan, 2000). Similarly, a mastery *goal orientation* that focuses on the performance of a task is more valuable for self-regulation than an outcome goal orientation that focuses on the result of a performance (Dweck, 1986).

The *performance or volitional control phase* comprises the components of self-control and self-observation. Self-control is necessary for individuals to focus on performance and can be ensured by self-instruction, imagery, *attention focusing*, and *task strategies*. Whereas self-instruction describes inner speech processes concerning strategies and task execution (Schunk, 1982), imagery is a self-control strategy that uses mental pictures. Attention focusing aims to shield concentration against internal and external distractions by the use of volitional techniques (Kuhl, 1985). Task strategies can be used to reduce task complexity and rearrange subtasks in a meaningful structure (Weinstein & Mayer, 1986). Concerning academic contexts, learning strategies such as note taking and problem solving have proved useful (Zimmerman & Martinez-Pons, 1988).

Besides self-instruction, *self-observation* is a further method to improve self-control. The individual should monitor the performance in combination with its effects (Zimmerman & Paulsen, 1995) in order to gain information on necessary strategy adaption. This self-

observation can be simplified by hierarchical goal structures that refer to more specific and proximal processes. Feedback from self-observation should be close to the actual performance to allow for strategy correction (Bandura, 1986). Moreover, feedback that is informative, accurate, and positive in valence has proved to be especially helpful. One self-observation technique is self-recording as it helps to detect misleading behavioral patterns and their accompanying environmental conditions. Self-experimentation is another self-observation technique and comprises intentional variations of behavior to gain new insights about strategy adaption.

Following the cycle of self-regulation, the next phase concerns *self-reflection* processes. In the first step, the individual has to undertake *self-judgments* through self-evaluation to gain information about whether a previously set goal has been attained or not. This evaluation can be based on four different types of criteria. Mastery criteria use hierarchical goal structures to rank performance in a novice-expert sequence. Previous performance criteria are especially useful to display intraindividual progress concerning goal attainment. Normative criteria comprise the comparison of one's own performance with that of social counterparts and are often used by individuals with outcome goal orientations. In a team setting, collaborative criteria can be used to gain information about goal achievement. Highly interrelated to self-evaluation are *causal attribution* processes that are about the reasons for success or failure (Weiner, 1979). If a goal is not reached and the individual attributes this result to his or her ability, he or she will not react in an adaptive way as there are no possibilities to change this performance. Attributions of failure to strategy or effort are eligible as they give the individual a starting point to optimize behavior and therefore influence the self-reactions.

Self-judgment is followed by a specific self-reaction: If the individual was able to reach the previously set goal, self-satisfaction has a positive valence and will result in pursuing this line of action. If a goal was not reached, the individual is dissatisfied and likely will give up on the goal. The intensity of satisfaction or dissatisfaction is influenced by the intrinsic value

of the task or goal. Inferences that are drawn from self-judgment can be either defensive if an individual does not pursue a goal in order to prevent aversive emotions (e.g., helplessness, procrastination; Garcia & Pintrich, 1994) or adaptive. *Adaptive self-reactions* are desirable as they help the individual optimize strategies or performance parts to attain more challenging goals (Zimmerman & Martinez-Pons, 1992). The cyclical character of Zimmerman's process model of self-regulation (2000) is obvious as self-reactions influence future forethought phases by enhancing self-efficacy or intrinsic motivation as a consequence of self-satisfaction. This increased motivation in turn influences goal setting and volitional control why self-regulation can be seen as an ongoing process of behavioral optimization.

### 2.1.2 Development of Self-Regulation

Zimmerman (2000) describes the development of self-regulatory competences within a social-cognitive framework (Bandura, 1986) that emphasizes the influence of social resources. The hierarchical self-regulatory levels can be interpreted within a developmental perspective in general or within a skill-acquisition perspective, as these levels have to be passed with every new skill an individual acquires (Table 1).

The first level is an *observational level* of regulation as individuals can learn important characteristics of a competence by observing skilled models. These models act strategic and self-regulated because they have exemplary motivational orientations and metacognitive skills. The skill acquisition is especially successful if the model is perceived as similar to the individual and if using the skill has positive consequences for the model. Nevertheless, personally enacting the strategies is often necessary to really learn them. In the second step, the individual tries to imitate the model's general strategic performance, which is the *emulation level*. The individual's performance can be optimized if the model explicitly teaches the skill through social guidance and feedback. First uses of the strategy can motivate the individual to optimize the newly learned skill.

The third level of self-regulatory development is the *self-controlled level*. Deliberate practice that encompasses structured and motivated efforts to improve a skill and which is often accompanied by informative feedback through a teacher (Ericsson & Lehman, 1996) is central to this level. The individual can perform the newly acquired skill within a structured setting but without a model present. The highest developmental step is the *self-regulated level* in which the individual can perform the skill adaptively to changes in personal and environmental factors. Strategy usage can be optimized with regard to preceding consequences, and attention resources can be used to optimize outcomes.

Although this model explains different hierarchical stages of self-regulatory development, Zimmerman (2000) emphasizes that this sequence is not irreversible as in developmental stage models. Even if this sequence results in the most effective learning results, individuals can go back to previous stages if they decide that this will optimize their skill development.

Table 1

*Developmental Levels of Regulatory Competence (Zimmerman, 2000)*

Level	Name	Description
1	Observation	vicarious skill performance through competent model
2	Emulation	imitation of general skill performance with social guidance
3	Self-control	skill performance without social guidance in structured settings
4	Self-regulation	skill performance in adaption to changes in personal and environmental factors

time

## 2.2 Self-Regulated Learning

### 2.2.1 Definition and Components of Self-Regulated Learning

As mentioned above, the construct of self-regulation (Zimmerman, 2000) is not tied to a specific domain or research area, and the author emphasizes that it can be transferred easily to different domains. Therefore, it can be applied to learning processes and is then called self-regulated learning (SRL). Nevertheless, there are diverse definitions of SRL, and the difference between self-regulation and SRL is often not explained precisely in literature. Dinsmore, Alexander, and Loughlin (2008) investigated how metacognition, which is generally defined as thinking about thinking (Flavell, 1978), self-regulation, and SRL are connected. Although metacognition and self-regulation are rooted in slightly different research lines, both constructs emphasize the importance of monitoring and control processes concerning cognition and behavior. If these processes are referring only to academic contexts, most authors use the term SRL to focus on learning.

Zimmerman and Schunk (2011) define SRL as “processes whereby learners personally activate and sustain cognition, affects, and behaviors that are systematically oriented toward the attainment of personal goals” (p. 1). Therefore, the construct comprises self-directed knowledge acquisition, its adaptive usage as well as an ongoing actualization of knowledge in response to changing environmental factors (Bronson, 2000). Feedback loops support the individual in monitoring behavioral effectiveness and adapt less successful action lines by the use of self-regulated learning strategies. Although there are different conceptualizations of SRL (metacognitive focus: e.g., Leopold & Leutner, 2015; motivational focus: e.g., Usher & Pajares, 2008), most authors agree that it entails cognitive, metacognitive, and motivational components (Landmann et al., 2009). Whereas cognitive components describe strategy knowledge and the effective use of learning strategies to process information in an optimal way, metacognitive components refer to thinking about thinking (Flavell, 1978) and include

planning, monitoring, and reflecting on learning processes as well as adapting goals and strategies to learn more effectively. Motivational components subsume self-motivation, motivational beliefs such as causal attribution and self-efficacy as well as volitional strategies that help initiate and maintain learning processes.

To date, these volitional components have oftentimes been neglected in SRL models (Duckworth, Gendler, & Gross, 2014) or SRL models have reflected only one aspect of volition (e.g., effort in Hong and O'Neil's model, 2001). Volition is described as a necessary prerequisite to transform learning intentions into the actual use of learning strategies (Corno, 1993) and therefore has to comprise the inhibition of learning irrelevant behaviors during goal attainment (Duckworth & Seligman, 2006). It also supports effort and concentration when distractions are present (Corno, 2001). Although volition is a construct that originates in action-control theory (Kuhl, 1984), it is seen as highly relevant for learning processes and therefore for SRL (Zimmerman, 2011).

With regard to the remaining SRL components, action-control theory speaks in favor of an interdependence of motivation and volition (Heckhausen & Kuhl, 1985) and describes two forms of motivation. Choice motivation is important in the pre-decisional phase of an action when learning intentions are created (Garcia, McCann, Turner, & Roska, 1998) and comprises motivational beliefs and influences goal setting (Husman, McCann, & Crowson, 2000). Executive motivation is relevant for the post-decisional phase when intentions are implemented into an action course through instrumental strategies and has an impact on effort maintenance (Garcia et al., 1998). In line with this, Gollwitzer (1996) differentiates between a motivational mindset for choice motivation and a volitional mindset for executive motivation.

Concerning SRL theories, choice motivation represents the majority of motivational processes included in the models (self-efficacy, intrinsic motivation, etc.), whereas executive motivation is only rarely included although it is highly relevant for intention implementation and goal-directed behavior (Garcia et al., 1998). Because of this neglected integration of

volitional aspects into the framework of SRL, several authors argue for the necessity of cross-fertilizing action-control theory and SRL theory to gain a deeper understanding of volitional processes within SRL (Duckworth et al., 2014; Wolters, 2003b). When integrating volition into SRL it is necessary to develop a learning-specific conceptualization of volition. Reviewing previous research, it is obvious that the three constructs of academic delay of gratification (Bembenutty & Karabenick, 2004), procrastination (Steel, 2007), and future time perspective (Dewitte & Lens, 2000) represent important volitional constructs within learning research and are highly interrelated. As Bembenutty and Karabenick (2004) state, it would be necessary to investigate these three concepts within an SRL framework. Following this outline of SRL components, the next sections aim to depict different models of SRL and describe how the components are theoretically hypothesized to relate.

### 2.2.2 Models of Self-Regulated Learning

#### **Component-Process Distinction**

In general, two types of models are used to describe SRL. On the one hand, component models specify different levels of regulation and are relatively static (Landmann et al., 2009). Therefore, they consider SRL as a rather stable competence that is characterized by distinct model components. One example is the three-layer model of SRL (Boekaerts, 1999) that focuses on the interaction of cognitive, metacognitive, and motivational regulatory processes that refer to three hierarchical layers (see Figure 3). The inner layer concerns the regulation of information processing and represents cognitive learning strategies that are used during the learning process. The second layer concerns the regulation of the whole learning process and focuses on the usage and control of learning strategies. Therefore it represents metacognitive knowledge and the use of metacognitive strategies. The outer layer refers to the regulation of the self and therefore encompasses motivational components such as goal setting and resource activation. Although the layers interact with each other, the model is relatively stable as it



describes different regulatory focuses that require using layer-specific strategies to optimize learning processes. As there are no feedback loops included, behavioral adaptation is not a central part of the model.

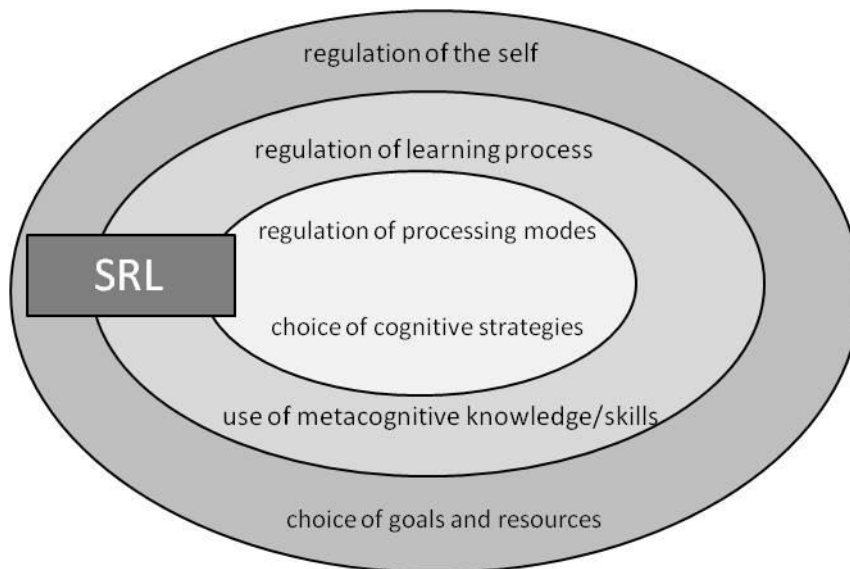

*Figure 3.* Three-layer model of self-regulated learning (adapted from Boekaerts, 1999).

On the other hand, process models describe SRL as a dynamic state that changes in dependence on environmental and situational conditions (Schmitz & Wiese, 2006). This adaptation can be ensured through feedback loops that inform the individual about ineffective strategies or unrealistic goals and therefore help optimize learning behavior (Landmann et al., 2009). The present thesis is based on the process model of self-regulation (Zimmerman, 2000) that can easily be transferred to learning processes (see section 2.1.2). The sequence of planning, performance, and reflection phases that are cyclical and connected by feedback loops help derive intervention methods to foster SRL. As each of the phases entails important components, interventions can be designed using these components as guidelines for specific methods.

### **Trait-State Distinction**

Besides this component-process distinction, SRL models can be differentiated with regard to the trait-state categorization that focuses more on the time perspective of the construct. This

differentiation originates in the research field of personality (Chaplin, John, & Goldberg, 1988) but has been transferred to the field of SRL (Hong & O'Neil, 2001). Traits are described as stable personal features that do not change in response to environmental conditions (Hertzog & Nesselroade, 2003). Trait SRL is then seen as general learning disposition (Boekaerts & Corno, 2005) that determines the use of cognitive, metacognitive, and motivational learning strategies. In line with this, Corno (2001) describes SRL habits as behavioral routines that concern effort and resource management as well as SRL tactics and strategies that are used regularly.

Contrarily, states are seen as personal features that are dynamic and changing intraindividually with regard to time and situations (Hertzog & Nesselroade, 2003). Therefore, they “represent dimensions of intraindividual variability over time or occasions” (Schmitz & Wiese, 2006, p. 65). State SRL can be described as situation-dependent changes in metacognitive effort or motivational resources. A learning state refers to learning behavior during one day and is bound by a given learning task. Thus, a learning sequence represents the learning process and is the combination of several states (Schmitz & Wiese, 2006).

Although component models of SRL are more in line with trait conception, and process models of SRL describe dynamic states, a clear distinction between these types of models is not always possible: Winne and Perry (2000) postulated that SRL has “properties of an aptitude and an event” (p. 534) and Matthews, Schwean, Campbell, Saklofske, and Mohamed (2000) describe SRL as a concept with nomothetic (trait) and idiographic (state) qualities. In line with this, Schmitz and Wiese (2006) argue that Zimmerman's process model is not a mere state model as the author does not make specific statement on the model's time frame. Moreover, Zimmerman (2000) speaks of “highly self-regulated individuals” (p. 17), which is more in line with a trait conception, and Schmitz (2001) emphasizes, that state and trait components are mixed within the levels of Zimmerman's model (2000).

### ***Example of a state model of SRL***

Based on the abovementioned discussion, Schmitz and Wiese (2006) proposed an adaption of Zimmerman's model that is only suitable for learning states and is very short-term. It therefore includes situational components that influence the learning process. The phases of forethought, action, and reflection refer to single learning actions that are bounded through specific start and end points of learning tasks. The cyclical nature of this model underlines the dynamic character of learning states that can be optimized through feedback loops (see Figure 4).

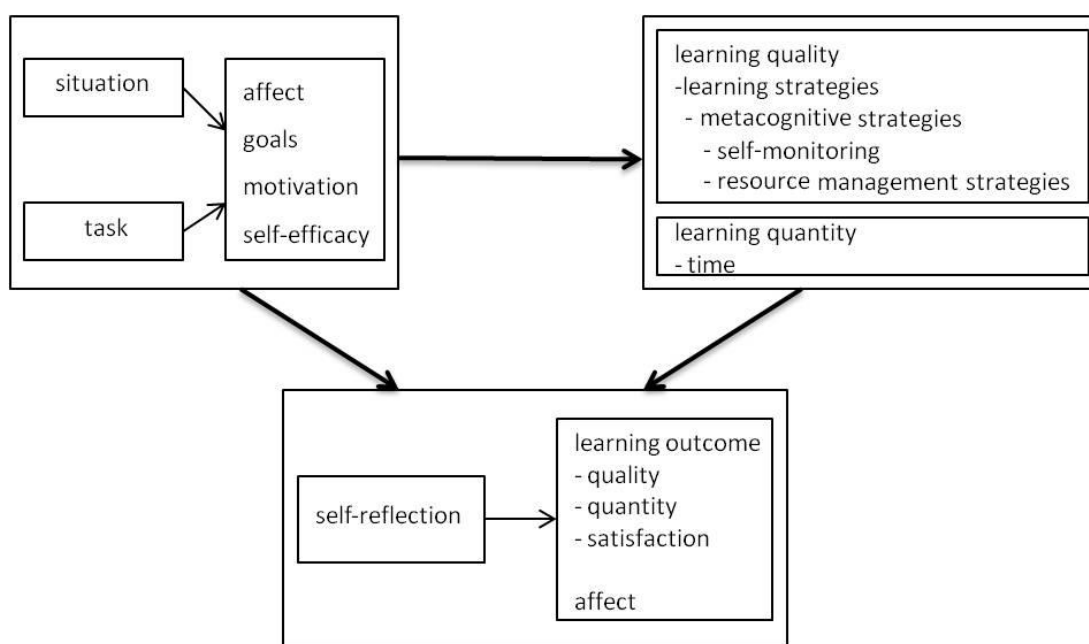

Figure 4. State model of self-regulated learning (Schmitz & Wiese, 2006)

The pre-actional phase comprises several components that are influenced by situational aspects (e.g., stress, demands) and task characteristics. Besides goal setting and affect (Boekaerts, 1997), motivational aspects are of high relevance. Intrinsic motivation comprises satisfaction for the learning activity itself and is especially supportive for learning outcomes (Deci & Ryan, 2000). Moreover, self-efficacy is a crucial component of the pre-actional phase as it influences effort, persistence, the use of learning strategies, and achievement (Schunk & Ertmer, 2000). The action phase of learning is divided into quantity and quality. Whereas learning quantity describes the time invested into specific learning behaviors, learning quality

comprises volitional and learning strategies. Metacognitive strategies (planning, regulation, and monitoring) and resource-management strategies (internal and external) are seen as especially supportive learning strategies. Volitional strategies include attention and motivation control (Kuhl & Fuhrmann, 1998) and help to overcome procrastination as well as to handle distractions. The post-actional phase contains self-reflections, i.e., the judgment and evaluation of the learning outcome compared to previously set goals. These evaluations can be concerned with the quality and the quantity of learning outcomes. Depending on the level of goal attainment, self-reflections can result in positive (satisfaction) or negative (dissatisfaction) affect. Adaptive self-reactions should follow the non-achievement of a goal and can contain goal or strategy modifications for the next learning cycle.

#### ***Example of a trait model of SRL***

Although state models have recently gained importance (Alexander, 2013), trait models of SRL are necessary to predict individual differences (Hong & O'Neil, 2001) and to examine training-induced SRL changes. Following a developmental or longitudinal research line, SRL has to be assessed as a trait because an investigation of two states and their change from the first to the second measurement point would not be very informative because of the dynamic and unstable character of states (Breuer & Eugster, 2006). One example of a trait model of SRL is the model of Hong & O'Neil (2001, Figure 5). In their model, SRL is conceptualized as a third-order factor that is superordinate to the second-order factors of motivation and metacognition. These two factors are highly relevant components of SRL and therefore are part of most SRL models and definitions (Efklides, 2011). Both factors in turn integrate important SRL subcomponents. Whereas the metacognitive factor includes planning and self-checking, the motivational factor subsumes effort and self-efficacy. It is obvious that these motivational components are of different nature as self-efficacy is a motivational belief that refers to attitudes about one's own competences (Bandura, 1997) and therefore impacts goal setting, whereas effort includes deliberate behaviors during the pursuit of a goal (Carver &

Scheier, 2000) and is therefore volitional in nature (Zimmerman, 2000). This is an important advantage of the model as most SRL models have neglected volitional components despite their relevance in the pursuit of goals (Garcia et al., 1998).

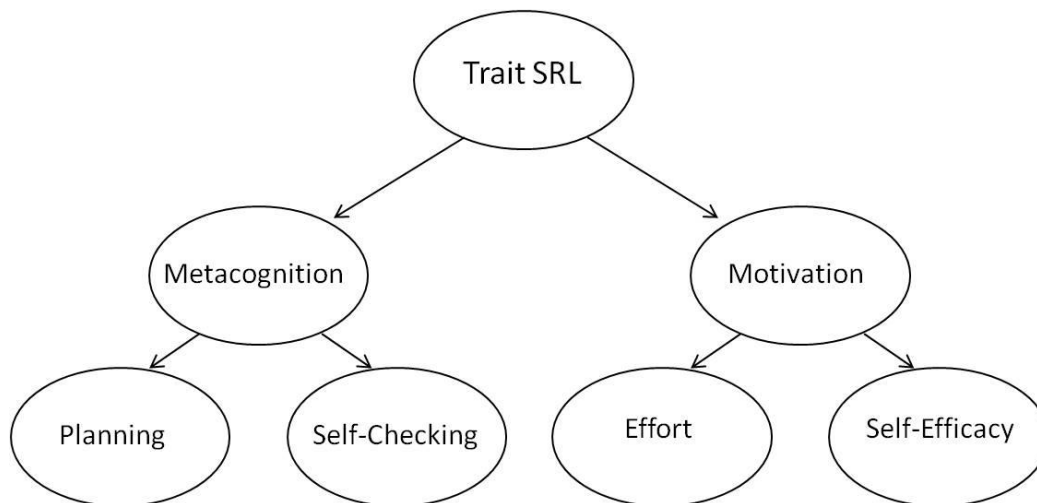

*Figure 5.* Trait model of self-regulated learning (Hong & O’Neil, 2001)

Nevertheless, it is obvious that Hong and O’Neil’s model (2001) has several limitations. It both simplifies the motivational belief and volitional component by representing them through only one subcomponent (self-efficacy and effort). Moreover, the model does not integrate a second-order cognitive factor, although most authors agree that SRL comprises cognitive components besides motivational and metacognitive components (Boekaerts, 1999). Additionally, the metacognitive construct of self-checking mixes the components of self-recording and self-evaluation, which are seen as distinct SRL strategies that occur in different phases of learning (Zimmerman, 2000).

### ***Integration of Trait- and State-Models***

Although there are distinct models to describe SRL as trait and as state, SRL is seen as a cumulative process, which is why Schmitz and Wiese (2006) argue that changes in state SRL should influence trait SRL if they operate similarly for a longer time period. Reciprocally, trait models are supposed to be superordinate to state models as the sequence of single states

is imbedded within the trait (see Figure 6). Therefore, traits should influence states to a specific extent. This assumption is in line with Hong's (1995) findings that state and trait SRL are highly interrelated and that both constructs positively influence academic success.

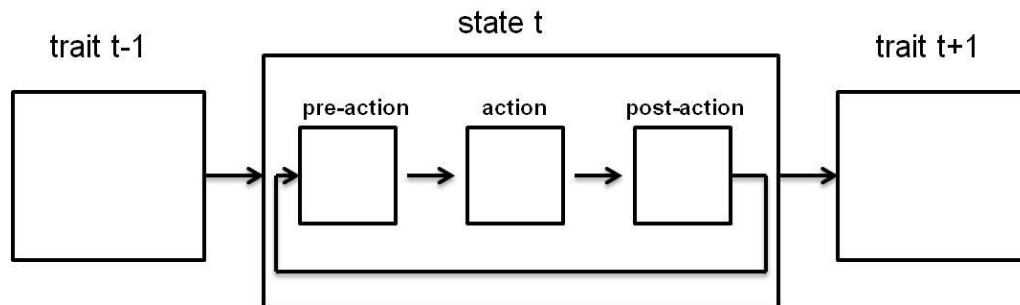

Figure 6. State-trait conception of SRL (see Schmitz, Landmann, & Perels, 2007, p. 321).

Accordingly, Schmidt (2009) proposed a model that integrates both perspectives (see Figure 7). State SRL comprises the three cyclical phases of pre-action, action, and post-action and all phases encompass metacognitive and motivational components, with the pre-action phase including an assessment of situational conditions. State SRL is imbedded within trait SRL, which covers the same components but is not distinguished into cyclical phases. Trait SRL is therefore task- and situation-independent and describes the SRL abilities an individual has. Both trait SRL and state SRL are in turn influenced by individual traits such as intelligence, personality, and personal values. Schmidt (2009) could mainly confirm these hypotheses and showed that personality variables predict trait SRL and that both personality and SRL traits predict SRL states. The integration of trait and state perspective therefore could be fruitful for practical reasons as knowledge of SRL traits helps to predict the effectiveness of interventions for specific groups of participants. Moreover, SRL traits can be useful in the development of content-independent training materials that can be used with several groups and that are useful for a wide range of learning situations.

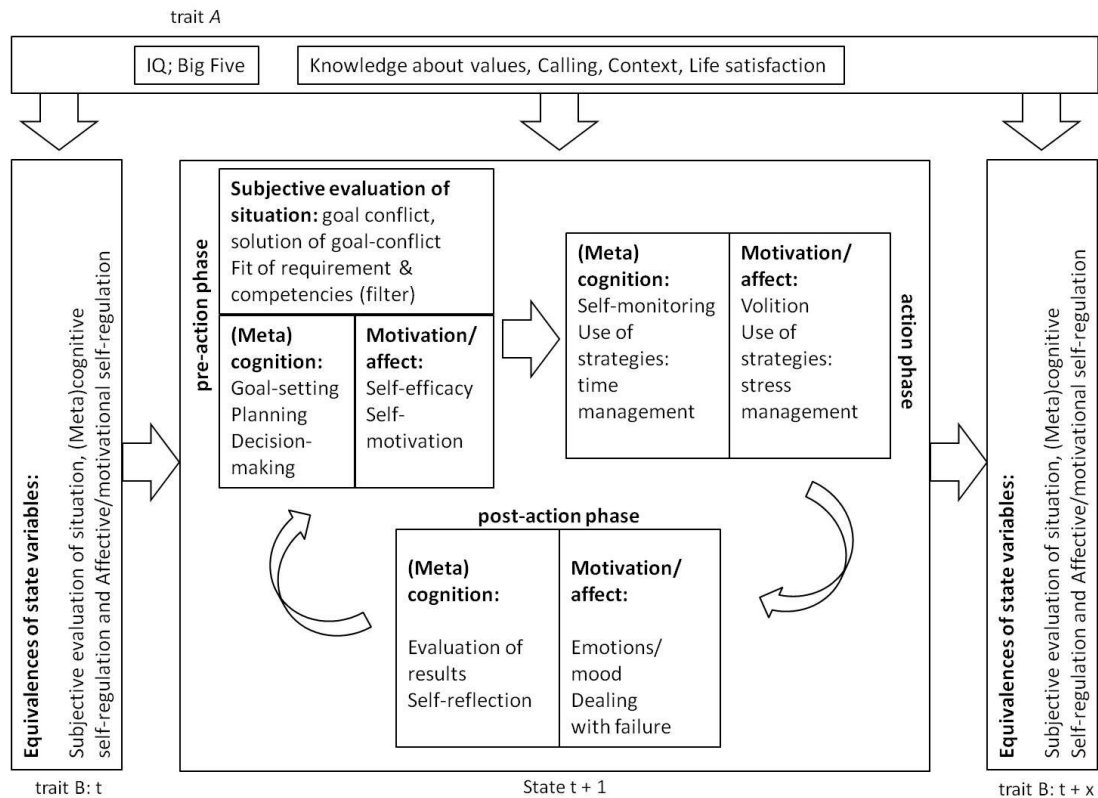

Figure 7. Integrative state-trait model of self-regulated learning (Schmidt, 2009).

*Research desiderates:* As trait models have been eclipsed by state models because of their relevance for theory and practice, research findings concerning trait SRL models are sparse. Nevertheless, some trait models of SRL have been proposed (e.g., Hong & O'Neil, 2001) but they have several points of criticism and cannot be easily transferred to state SRL. Using Schmidt's research (2009) as a base for the development of a model that integrates trait and state SRL and that can be used to investigate a connection of both levels would be desirable. As trait models superordinate state models, it would be necessary to first develop a trait model that can then be transferred to the state level. Moreover, trait models help to understand individual differences in SRL and differential effects of SRL interventions (Hong & O'Neil, 2001). As mentioned above, trait models should integrate volitional components besides cognitive, metacognitive, and motivational components, as these have mostly been neglected in SRL models so far (Garcia et al., 1998).

### 2.2.3 Individual Differences in Self-Regulated Learning

As the introduction clarified, SRL is highly relevant in the context of college learning and is hypothesized to be compounded of several cognitive, metacognitive, motivational, and volitional factors. Defining SRL as a trait that describes a general learning disposition (Boekaerts & Corno, 2005) and which is determined by the use of cognitive, metacognitive, and motivational learning strategies leads to the assumption that interindividual differences in this competence exist. This assumption is supported by research results that investigated differences in SRL regarding academic achievement levels (e.g., Broadbent & Poon, 2015; Zhu et al., 2016). Since this thesis focuses on college students, only findings from this group will be shared although the relationship between SRL and achievement is obvious for younger students as well (e.g., Throndsen, 2011; Zimmerman & Martinez-Pons, 1986).

Highly self-regulated college students are characterized by the application of self-regulative strategies before, during, and after test taking and achieving higher scores than college students who report less strategy usage (Kitsantas, 2002). In line with this, high-achieving students seem to use more SRL strategies in general and more SRL strategies that are different from each other (Nandagopal & Ericsson, 2012; Sundre & Kitsantas, 2004). In contrast, low-achieving students seldom use previous results to adapt their learning behavior (Hacker, Bol, Horgan, & Rakow, 2000). This supports the results of Valle et al. (2008), who found three clusters of SRL in college students (low, middle, and high) that were predictive of achievement level. A similar result stems from Barnard-Brak, Lan, and Paton (2010), who determined five quantitatively different SRL profiles in college students; consistent with the hypothesis that SRL positively influences academic achievement, students with the most advantageous profile of SRL strategy use showed the highest achievement. Moreover, Liu et al. (2014) conducted a cluster analysis on SRL abilities and found two adaptive and two maladaptive SRL clusters that were related to achievement level. Although the construct of



SRL in general has a high relevance for college student learning, time management strategies (Kitsantas et al., 2008), elaboration strategies (Tynjälä et al., 2005), and self-efficacy (DiBenedetto & Bembenuddy, 2011; Richardson et al., 2012) seem to have special importance for academic success. A recent meta-analysis (Sitzman & Ely, 2011) underlines the importance of metacognitive strategies, motivation, attribution, goal-setting, and self-efficacy for successful learning processes.

Besides achievement, personality is an important factor when analyzing individual differences in SRL (Schmidt, 2009; Zeidner, Boekaerts, & Pintrich, 2000). Personality traits are defined as stable individual differences that help to understand individual patterns of cognitions, behaviors, and emotions (Hogan, Hogan, & Roberts, 1996). Eilam, Zeidner, and Aharon (2009) therefore argue that personality traits could influence students' interaction with their learning environment and therefore have an impact on the relation between ability and achievement. In this context, the Big Five traits are central for investigating personality factors, and Bidjerano and Dai (2007) summed up several findings concerning their relationship with learning and SRL: Conscientiousness and openness to experience are supposed to positively influence learning as they are positively related to strategies that are part of SRL (e.g., motivation, Chamorro-Premuzic & Furnham, 2003; analytic learning, Geisler-Brenstein, Schmeck, & Hetherington, 1996; elaborative strategies, Slaats, van der Sanden, & Lodewijks, 1997). In line with this, they found both these personality traits to be positively related to metacognitive, elaborative, and motivational SRL strategies (Bidjerano & Dai, 2007).

In contrast to this distinct positive relationship, the findings concerning the relationship of agreeableness and extraversion with SRL strategies are somewhat ambiguous. Whereas agreeableness is positively related to effort (Eilam et al., 2009), it is also related to surface learning, which is a less optimal learning strategy (Slaats et al., 1997). Extraversion can support learning by promoting social behaviors such as help seeking, but this trait is found to

be related to less reflective problem solving abilities (Matthews, 1997). Concerning neuroticism, there is agreement that this personality trait has a negative influence on learning and academic outcomes as it is related to lower analytic ability and conceptual understanding in combination with a surface approach (Matthews & Zeidner, 2004). Similar to neuroticism, test anxiety is a learning-relevant trait, especially in college environments, although it is not one of the Big Five personality traits. It is found to have negative effects on SRL (Artino & Stephens, 2009; Bembenutty, Mc Keachie, Karabenick, & Lin, 1998; Kesici et al., 2011) and academic achievement (Warr & Downing, 2000).

*Research desiderates:* It is obvious that SRL is related to achievement level as well as to several personality traits that can act as facilitators or suppressors of successful (college) learning. Several studies have already pursued the cluster approach to determine SRL profiles that are either positive or negative for learning. As previous research resulted in different numbers of SRL profiles for college students (three, four, five), future research is needed to determine which SRL components determine adaptive or maladaptive SRL clusters and how these are related to achievement. Following such a person-centered approach (Niemivirta, 2002), it would be of interest to investigate how these profiles differ with regard to personality factors. As there are inconsistent results about agreeableness and extraversion, a more thorough investigation of their influence on SRL is needed (Schmidt, 2009). In general, research on the interaction of personality with SRL is sparse and has to be increased (Bidjerano & Dai, 2007).

### 2.3 Fostering Self-Regulated Learning

Although SRL is important for postsecondary academic success, college students oftentimes show deficits in the knowledge and application of SRL strategies (Bembenutty, 2011b) and tend to overestimate their competences, which can lead to underachievement because of

missing regulatory behavior (Dunlosky & Rawson, 2012; Koriat & Bjork, 2006). This finding hints at an inadequate calibration and missing SRL (especially metacognitive) competencies (Cohen, 2012; Hadwin & Webster, 2013; Peverly et al., 2003), which is why college students have a special need for SRL support. Despite this relevance, opportunities to improve cross-curricular competences such as SRL are rarely institutionalized in German universities (Paetz et al., 2011). Because of this and the construct's relevance, it is important to gain new insight into how to foster SRL most effectively in college students. Kitsantas et al. (2008) suppose that "the ability to self-regulate [...] [is] a learned skill" (p. 64), and Schunk and Ertmer (2000) state that "self-regulation is not an all-or-none phenomenon [but] refers to the degree that students are metacognitively, motivationally, and behaviorally active in their learning" (p. 632). Concordantly, Manning, Glasner, and Smith (1996) emphasize that no individual is totally self-regulated, and Stoeger and Ziegler (2011) conclude that there is extensive evidence showing that SRL can be taught. In conclusion, it seems to be necessary and possible to foster SRL through strategy instruction and training.

Interventions to foster SRL are classified into direct and indirect interventions (Schmidt & Otto, 2010). Whereas direct interventions are aimed at the learner and are designed to impart SRL strategies, indirect interventions aim to improve learning environments, e.g., through training of people who influence learning (e.g., teachers). As college learning oftentimes takes place at home, this represents an autonomous environment that is not guided by teachers. Therefore, direct interventions are the method of choice to foster SRL in college students. Trainings that impart strategy knowledge and practice are the most common intervention method in the field of SRL. In this context, fostering self-monitoring through learning diaries is highly relevant to boost training effects (Schmitz & Wiese, 2006). Nevertheless, both methods can be used independently to support students' SRL. The following sections give an overview of research on trainings, learning diaries, and their combination.

### 2.3.1 Trainings

Trainings that aim directly to enhance learners' SRL have been found to be effective in different learning environments. SRL trainings can be conducted successfully in preschool (e.g., Perels, Merget-Kullman, Wende, Schmitz, & Buchbinder, 2009), primary school (e.g., Dignath et al., 2008; Throndsen, 2011), and secondary school (Perels et al., 2005; Perels et al., 2009) and support the assumption that SRL is an important prerequisite for lifelong learning (Lüftenegger et al., 2012). Concerning school context, trainings are especially effective when contextualized within specific subjects (Hattie, Biggs, & Purdie, 1996; Dignath et al., 2008) because students can transfer strategies easily to general problem solving in the specific domain such as mathematics, reading, or writing (Brunstein & Glaser, 2011; Fuchs et al., 2003; Souvignier & Mokhlesgerami, 2006).

With regard to the college context, Simpson, Hynd, Nist, and Burrell (1997) classified programs to foster learning strategies into five categories: learning-to-learn courses (semester-long, developmental in nature, psychological concept as base, focus on SRL through learning strategy instruction), supplemental instruction (developmental in nature, strategic learning concepts are embedded within specific courses), programs for underprepared and at-risk students (e.g., in reading and writing), general reading and writing courses (sometimes in combination with learning strategy instruction), and learning assistance centers (courses and tutoring for various study skills). Weinstein, Husman, and Dierking (2000) conclude that learning-to-learn courses have the highest potential to positively influence academic achievement and strategy transfer. As these courses teach conditional, declarative, and procedural knowledge in combination with learning strategies and self-regulation components, students are prone to use their knowledge across different academic situations.

In line with this, there are several studies that hint at the usefulness of trainings to foster SRL in college students: Schmitz (2001) and Schmitz and Wiese (2006) showed that a

training on learning and volition strategies was appropriate to enhance college students' SRL. Moreover, these trainings positively influence academic results: Weinstein et al. (2000) conducted training on motivation, goal setting, planning, and monitoring and found positive effects on grades and graduation rates. Achievement is also positively influenced through a training of reflection and attribution strategies (Masui & De Corte, 2005; Zimmerman, Moylan, Hudesman, White, & Flugman, 2011) as well as goal-setting and monitoring strategies (Nunez et al., 2011). Training can also enhance students' motivation about a specific topic and therefore positively influence their achievement (Leutner, Barthel & Schreiber, 2001). Additionally, it has been shown that training effects can be long-lasting as trained students showed higher grades four semesters after the training (Bail, Zhang, & Tachiyama, 2008). Moreover, web-based training has been shown to foster SRL in college students (Bellhäuser, Lösch, Winter, & Schmitz, 2016). Although SRL trainings have been found to be effective, they oftentimes focus on only one or two specific SRL strategies instead of supporting the whole SRL cycle.

As in a school context, SRL trainings in college are often linked to specific fields of study and combine SRL strategies with subject-specific contents (business economics, Masui & DeCorte, 2005; mathematics, Zimmerman et al., 2011). Schober, Wagner, Reimann, and Spiel (2008) conducted an online training to impart SRL strategy knowledge and knowledge on research methods in psychology and found it to be effective. Training participants showed higher scores on the exam at the end of the semester than the students who did not participate in the training program. Despite the effectiveness of content-specific SRL training, content-independent SRL trainings have economic advantages, especially in college. A multiplicity of college subjects makes it necessary to develop training that can be applied ubiquitously with all groups of students. Such content-independent trainings have also been found to be effective (Bail et al., 2008; Hofer & Yu, 2003; Reeves & Stich, 2011; Schmitz, 2001) as

optimizing general learning habits and attitudes as well as dealing with learning problems is an important competence in every field of study (Dembo & Seli, 2004).

*Research desiderates:* Although several studies speak in favor of the effectiveness of SRL training to enhance study skills and academic achievement, SRL training programs often focus on specific SRL strategies (e.g., time management, self-reflection) and therefore neglect other important strategies. As a guideline for developing SRL interventions, Goetz, Nett, and Hall (2013) summarize seven aspects of classroom instruction that are highly important when fostering SRL: challenging and realistic goal setting, monitoring learning behavior, planning learning strategies, evaluating own achievement, motivation through reinforcement for appropriate behavior, degrees of freedom when practicing specific tasks, and regulating learning behavior (see Ormrod, 2006). Interventions that include instructions on all these aspects should be especially effective. Therefore, it is necessary to develop training programs that impart strategy knowledge concerning all SRL components and that provide a theoretical framework so that students can transfer their SRL knowledge into different academic challenges. Strategies that are part of training programs should represent the categories of motivational, volitional, cognitive, and metacognitive strategies (Boekaerts, 1999) and should reflect the whole SRL cycle (forethought, performance, and reflection phase; Zimmerman, 2000). Such multiphase trainings that provide a comprehensive framework for participants make it easier to evaluate the effectiveness of learned strategies and support optimal performance and motivational attitudes (Cleary, Platten, & Nelson, 2008; Zimmerman, 2008).

### 2.3.2 Fostering SRL through self-monitoring

Besides trainings that impart SRL strategy knowledge and practice, increasing self-monitoring seems promising to foster SRL. Self-monitoring is a critical component of the performance phase of Zimmerman's model of self-regulation (2000) and comprises deliberate observations of one's own behavior (Lan, 1996). It therefore provides information on proceedings, as the

individual is able to observe his behavior online, which is why behavioral alterations can be conducted just in time (Klug, Ogrin, Keller, Ihringer, & Schmitz, 2011). In line with this, Pressley and Ghatala (1990) define self-monitoring as “an executive process, activating and deactivating other processes, as a function of on-line evaluation of thought processes and products as they occur” (p. 19). The individual therefore learns about discrepancies concerning planned action lines and thus is able to correct his or her behavior and adapt ineffective strategies (Bandura, 1982). Strategies such as attention focusing and self-instruction can be helpful to adapt the action line most effectively. Self-monitoring supports the evaluation of learning strategies’ effectiveness as the learner assesses if the strategy supports goal achievement and how much effort he or she has to release to use this strategy (Pressley & Ghatala, 1990). Besides its central position within the performance phase of each self-regulation cycle, self-monitoring can refer to whole learning cycles; it then occurs on a higher-level order than learning itself and concerns the monitoring of the entire learning process and improvable parts of learning cycles (Schmitz et al., 2007).

Despite this relevance, “only about 20% of students reported using some self-monitoring strategies during their daily studying” (Lan, 2005, p. 122). As Zimmerman (1989) argued, students often are misinformed or uninformed concerning self-monitoring strategies, and they are prone to have low self-efficacy for the use of self-monitoring strategies. This is why interventions that aim to enhance self-monitoring are of crucial importance in college, and Goetz et al. (2013) recommend self-monitoring be part of an optimal SRL intervention.

Referring to the framework of SRL, standardized learning diaries are the method of choice to foster self-monitoring in a standardized way (Landmann et al., 2009). These diaries comprise short questionnaires that reflect forethought, performance, and reflection phases in reference to Zimmerman’s process model of self-regulation (2000). Learning diaries help to assess learning strategies and emotions more closely to actual behavior as the first part (forethought phase) is worked on before learning, whereas the second part (performance and

reflection phase) is worked on after finishing a learning action (Klug et al., 2011). As learning strategies, emotions, and cognitions are assessed, students have to think about them and become aware of otherwise unconscious behavioral acts. Learning diaries often have to be filled out daily, so they can induce self-monitoring which in turn fosters SRL (Klug et al., 2011; Zimmerman & Paulsen, 1995) and supports the optimization of the monitored behavior (Kanfer, Reinecker, & Schmelzer, 1996). “[T]hey serve as a self-instructional tool for documenting and reflecting learning processes” (Klug et al., 2011, p. 58) and therefore can trigger metacognitive thoughts (Schmitz & Wiese, 2006) that in turn enhance the use of self-regulated learning strategies.

Despite the hypothesized positive influence of learning diaries on self-monitoring and SRL, findings about their effects on SRL without any further intervention are ambiguous: some studies found a positive effect of learning diaries on SRL (Landmann, 2005; Schmitz & Perels, 2011) reflecting the so called reactivity effect that represents an alteration of behavior in a desirable way only because of self-monitoring of cognitions and own behavior (Korotitsch & Nelson-Gray, 1999). Dignath-van Ewijk et al. (2015) analyzed the effects of a learning diary for college students and found that students increased in metacognitive skills, metacognitive attitude, and time management. Nevertheless, the learning diaries used in this study incorporated strategy instruction that varied from week to week. Therefore, it can be assumed that the learning diaries were not mere self-reflection tools but served as direct SRL intervention. Whereas Dignath-van Ewijk et al. (2015) compared the learning diary intervention group only to a passive control group, Fabriz et al. (2014) compared the effects of a learning diary, a university SRL course, and their combination and found that only the combination of both methods had positive effects on SRL. The missing effect of the single learning diary in their study could be explained by the fact that students did not receive a theoretical framework to assess the usefulness of this intervention (Lan, 2005; Zimmerman & Paulsen, 1995).



In line with this result, several authors hypothesize that learning diaries should be especially effective when SRL interventions are added (Schmitz, Klug, & Schmidt, 2011; Schmitz & Wiese, 2006): Learning diaries have a high ecological validity as they are filled out at home in a familiar learning environment. Therefore, transfer to all-day learning tasks should be supported. Learning diaries, moreover, should remind training participants about the strategies learned during training and help exercise them at home. Additionally, metacognitive thoughts triggered by learning diaries should help identify ineffective learning processes. Finally, the daily routine of filling out the learning diaries resembles deliberate practice of the newly acquired learning strategies. This ambiguity concerning the benefits of learning diaries as a single intervention or as a training boost necessitates further investigation.

*Research desiderates:* As there are ambiguous results about how to best foster SRL in college, the impact of SRL trainings, learning diaries, and their combination has to be clarified. Because the effects of learning diaries and SRL trainings are often confounded (Schmitz, 2001), both single method effects as well as effects of their combination have to be investigated. Since the study of Fabriz et al. (2014) was the first to implement such a 2 x 2-design but did not find any effects for the single interventions, this result pattern has to be clarified by replicating the study. Fabriz et al. (2014) investigated the effects of a university course on SRL that did not directly train SRL strategies, which is why it would be interesting to know the results with an SRL intervention that is solely designed to impart strategy knowledge and increase students' SRL processes. Investigating this intervention in combination with a learning diary could result in new insights on how to foster SRL most effectively in college students.

### 2.3.3 Aptitude-Treatment-Interactions

The previous section clarified the necessity of interventions to foster SRL and summarized the positive effects of SRL-enhancing methods on learning and achievement. Following a person-centered approach (Bergman, Magnusson, & El Khouri, 2003; Snow, Corno, & Jackson, 1996), it is interesting to investigate how individual preconditions influence intervention effects and whether these effects are weakened or strengthened by specific learner characteristics (Bidjerano & Dai, 2007; Masui & De Corte, 2005). In this context, the analyses of aptitude-treatment-interactions (ATI) can result in new insights as given conditions in learners can influence their development, resulting of a specific instructional environment (Snow, 1992). Findings concerning such individual reactions to different instructional treatments can help adapt and tailor instructions so that they fit different learner types (Snow, 1976).

Aptitudes are defined as personal characteristics that influence the probability of succeeding given a specific treatment (Snow, 1976). Following Snow and Lohman (1984), five criteria have to be met to establish an aptitude theory for a specific construct:

- “1. To interpret the psychological nature of the individual difference construct to be considered an aptitude, and the measures considered to reflect this nature.
2. To specify the treatment situations for which the construct serves as aptitude, and the criterion measures to be used to validate this claim.
3. To demonstrate and explain the predictive, propaedeutic links that connect the aptitude, treatment, and criterion measures.
4. To demonstrate and explain the degree to which differential prediction exists for contrasting treatments.
5. To demonstrate and explain the degree to which the aptitude can be changed through reciprocal aptitude-treatment links.” (p. 349)

With regard to SRL, point 1 is fulfilled as several authors regard SRL as a trait that influences individual learning habits (Boekaerts & Corno, 2005). The fact that a large number of studies hint at the positive influence of SRL on achievement given regular school or college treatment (e.g., Kitsantas, 2002; Throndsen, 2011) refers to point 2 and point 3. Every learning situation can be regarded as treatment for SRL, and resulting achievement is seen as a criterion measure that validates this claim. With regard to point 4 and point 5, a reasonable number of studies hints at the changeability of SRL through interventions (Dignath et al., 2008) and at the fact that different interventions are not equally effective for all groups of learners (e.g., Fabriz et al., 2104).

Besides the fact that ATI research enables a deeper investigation of instructional effects than just a comparison of different treatment groups (Borg & Gall, 1989), taking into account the heterogeneity of treatment groups can help to avoid misinterpretations of interventions (Lapka, Wagner, Schober, Grading, & Spiel, 2011). Following this research paradigm, Lapka et al. (2011) found that an online SRL intervention was only beneficial for students with specific motivational profiles. Whereas competence-oriented students and students with motivational deficits could benefit from an intervention to foster SRL in combination with psychology methods, motivationally balanced students showed no increase in criterion variables. Additionally, a study by Gonzalez-Pienda, Fernandez, Bernardo, Nunez, and Rosario (2014) lead to the conclusion that only participants with a low SRL baseline benefited from an SRL training indicating a compensation effect (Klauer, 1993). Students with low SRL strategy knowledge are able to practice and therefore automatize the strategies taught in an SRL intervention, whereas highly self-regulated learners have a low potential to develop their SRL skills any further. As newly learned strategies first have to be internalized to be transferred to other learning challenges, it can be hypothesized that the increase occurs not directly after training but later in development (Hager & Hasselhorn, 2000). An alternative hypothesis is that students with moderate SRL skills would especially benefit from an

intervention as they have a base on which to develop their strategies, whereas low SRL students first have to acquire basic SRL skills (Barnard-Brak et al., 2010).

Contrary to this compensation effect, it is possible that ATI-research in SRL shows the so-called Matthew effect, which indicates the advantageous development for students that started with high skills (Walberg & Tsai, 1983). As high SRL students possess skills to effectively control their cognitions and motivation, they are prone to benefit from strategy training as they can apply the strategies more easily than lower SRL students (Alexander, Carr, & Schwanenflugel, 1995).

Although ATI has the potential to detect differences in positive effects for different subgroups for learning, it can also uncover possible negative effects of interventions that result of a poor fit between individual preconditions and treatment (“mathemathanic effects”, Lohman, 1986, p. 192). With regard to SRL interventions, it can be hypothesized that linear instructional designs are rather negative for high SRL students as they prefer independent problem-solving (Feuerstein, 1980).

*Research desiderates:* Although there is awareness about the fact that individual differences can influence intervention effects and can even lead to misinterpretations of these effects, few studies have adopted an ATI-framework in SRL research. Therefore, it would be interesting to investigate how different groups of students benefit from an SRL intervention to create guidelines for designing optimal instructions. As findings about this research question are sparse in the field of SRL, it is difficult to derive a hypothesis concerning the effectiveness of interventions for specific groups of learners. One possibility to gain first insights would be to investigate the presence of SRL profiles in college students as a few authors have already done (e.g., Liu et al., 2014; Valle et al., 2008) and to analyze how students with different profiles benefit from an intervention to foster SRL.

### 3 Research Aims

Based on the theoretical frameworks and empirical findings summarized in the preceding section, this thesis pursues the overall aim of modeling and fostering SRL in college students by including a differential perspective. This comprehensive question should help gain new insights into the SRL processes of college students and should result in guidelines on how to foster this competence most effectively for this target group. Therefore, the thesis aims to answer questions of theoretical and practical relevance. The derivation of research aims is based on the before-mentioned research desiderates with the aim to provide new insights on these unreserved issues. The modeling part of the thesis comprises the investigation of SRL's structure and the interrelation of important components with the aim to develop a trait model of SRL that integrates volitional components besides cognitive, metacognitive, and motivational components (study I). This model could provide guidelines when developing intervention programs to foster SRL. The fostering part of the thesis takes into account the findings of study I and addresses the question of how to foster SRL most effectively in college. Therefore, it investigates the usefulness of an active SRL training that incorporates the components of the trait model, a structured learning diary that should enhance self-monitoring, and the combination of both methods (study II). The differential part is pursued by analyzing the presence of different SRL profiles, investigating their relation to achievement levels and personality structure and their influence on the effects of the above-mentioned SRL training adopting an ATI framework (study III). These three aims simultaneously represent the research objective of the three empirical studies the thesis is grounded on.

### 3.1 Aim 1

As mentioned above, SRL can be conceptualized as state or as trait (Hong, 1998). Although state models are highly relevant to explain changes in self-regulated behavior, trait models are important as well as they can be used to investigate individual differences in SRL (Boekaerts & Corno, 2005). The trait model of Hong and O'Neil (2001) is a first attempt to describe SRL as a third-order trait that subsumes several motivational and metacognitive components. Nevertheless, the model has several shortcomings as it does not integrate a cognitive component, represents motivation and metacognition by only two subcomponents each, and neglects the volitional component. Therefore, the first aim of the thesis is to develop and evaluate an integrative trait model of SRL that addresses these shortcomings.

On the one hand, the model should incorporate a cognitive factor, as several authors agree that SRL is composed of metacognitive, motivational, and cognitive factors (e.g., Boekaerts, 1999). On the other hand, a volitional factor will be integrated and investigated with regard to its position within SRL. As volition has oftentimes been neglected in SRL research (Garcia et al., 1998), a new conception of trait volition for SRL has been developed by integrating future time perspective, academic delay of gratification, and procrastination. These constructs are very relevant in the field of college learning and show a high interrelation (Bembenutty & Karabenick, 2004). Comparing a model that treats this volitional factor as a separate factor from metacognition, cognition, and motivation (Corno, 2001) with a model that subsumes volition under the broader term of motivation and therefore supplements motivational beliefs (Zimmerman, 2008) will give new insights into the structure of trait SRL.

In summary, the first research aim of this thesis is to develop and evaluate a new conception of trait volition for learning and investigating this trait within an integrative model

of SRL. The results can serve as a base to develop effective fostering methods that treat all relevant components of SRL.

### 3.2 Aim 2

College students have a special need for SRL (Bembenutty, 2011b) as to why programs to foster this competence are highly relevant for this target group. Nevertheless, institutionalized SRL interventions are scarce, and this is particularly true for German universities (Ceylan, Fiehn, Paetz, Schworm, & Harteis, 2011). As there are different methods to foster SRL, the second aim of this thesis is to investigate how this competence can be fostered most effectively in college students. Therefore, a training program, a self-monitoring intervention, and a combination of the two will be compared.

Trainings that impart strategy knowledge and practice have proved useful to foster SRL (e.g., Reeves & Stich, 2011). Nevertheless, they often focus on specific SRL strategies and neglect other important components. Therefore, the aim was to develop a comprehensive training that treats all categories of SRL strategies (motivational [motivational beliefs and volition], cognitive, metacognitive; Boekaerts, 1999) and all phases of an SRL cycle (forethought, performance, reflection; Zimmerman, 2000). Such a holistic framework supports students' understanding of strategies and helps them assess their usefulness (Cleary, Platten, & Nelson, 2008). As a further aim, the training should be content-independent to make it applicable with all groups of students. Although content-specific trainings have proved useful for college students (e.g., Wagner, Schober, Grading, Reimann, & Spiel, 2010), content-independent trainings are highly desirable because of their economic benefit and effectiveness (e.g., Hofer & Yu, 2003).

Besides direct strategy trainings, SRL can be fostered through self-monitoring interventions. These are mostly designed as structured learning diaries that comprise questions concerning forethought, performance, and reflection phases of learning and that

have to be filled out daily to stimulate self-monitoring processes. It has been shown that learning diaries positively influence the self-monitoring of students, which in turn fosters SRL (Fabrizz et al., 2007). Nevertheless, there is inconsistent data concerning their effectiveness without further interventions: Whereas some studies speak in favor of their positive influence on SRL without training (e.g., Dignath-van Eijwijk et al., 2015), other studies did not find any effect when no further intervention was added (e.g., Fabrizz et al., 2014). Therefore, the second aim of the thesis is to investigate how SRL can be fostered most effectively. As there is evidence that the combination of trainings and learning diaries have an additive effect (Schmitz & Wiese, 2006), it was hypothesized that the combination of both interventions would result in the highest effect on college students' SRL.

### 3.3 Aim 3

It is evident that SRL is highly relevant in the field of college learning and has to be fostered (Bembenucci, 2011b; see aim 2). Nevertheless, there are individual differences in the knowledge about and the usage of SRL strategies, which are related to personality factors such as conscientiousness, openness to experiences, and neuroticism (Bidjerano & Dai, 2007) and which in turn influence academic achievement (e.g., Broadbent & Poon, 2015). Several studies hint at a positive relationship between SRL and academic achievement (Kitsantas, 2002; Valle et al., 2008). Moreover, these differences can have an impact on the effectiveness of SRL interventions (Lapka, Wagner, Schober, Grading, & Spiel, 2011). The adoption of a person-centered approach is promising with regard to the development of adaptive training programs (Niemi-virta, 2002), but it is rarely applied in SRL research.

Therefore, the third aim of the thesis is to cluster individuals based on SRL subscales and to uncover specific SRL profiles. These profiles were then analyzed with regard to their relation to achievement level and personality factors in order to uncover what profiles are most beneficial for learning. Concerning the person-centered approach (Niemi-virta, 2002) and



ATI research (Snow et al., 1996), a further aim was to investigate how these profiles influence the effectiveness of SRL training. It was hypothesized that especially students with maladaptive SLR profiles would benefit from the training as they have the potential to increase their learning skills (Gonzalez-Pienda et al., 2014; Zohar & David, 2008).

## 4 Methodological Issues

To answer the research aims stated above, several statistical methods had to be used. Therefore, the following section will give an overview of these methods and briefly describes them with regard to the research questions.

### 4.1 Study I

The first study aimed to develop and evaluate a new conception of trait volition for learning by integrating future time perspective, procrastination, and academic delay of gratification. This volitional factor should then be integrated into a trait model of SRL that incorporates cognitive, metacognitive, motivational, and volitional factors. As these research questions comprise the investigation of dimensional structures of manifest variables, confirmatory factor analysis (CFA) and structural equation modeling (SEM) were conducted (Christ & Schlüter, 2012) using MPlus7 (Muthén & Muthén, 2012). The CFA technique investigates whether a priori defined measurement models with an explicit defined number of factors (latent variables) and their correspondence with indicators (observed variables) adequately represent the data (Kline, 2005). In study I, CFA was used to investigate the volitional factor model and the integrative trait model of SRL. As the SEM technique can be used to investigate correlational patterns between different latent variables or latent and manifest variables, it was adopted to analyze the relation between latent SRL and an achievement marker.

To decide whether a proposed model fits the empirical data, MPlus provides information on several fit statistics: The basic one is the  $\chi^2$ -value that is reported in combination with its degrees of freedom and the significance value. The null hypothesis that is tested assumes that the covariance matrix induced by the hypothetical model matches the estimated population covariance matrix (Christ & Schlüter, 2012). A significant  $\chi^2$ -value, therefore, indicates that the hypothetical model does not replicate the empirical data well enough. Nevertheless, this test is less reliable with large samples (Kline, 2005) and therefore should be interpreted in combination with other fit indices. The  $\chi^2/df$ -ratio is one option for further examination of model fit, and this ratio should be below 2:1 to indicate an acceptable fit to the data (Schermele-Engel, Moosbrugger, & Müller, 2003). An additional fit index is the CFI (comparative fit index), which compares the fit of the postulated model with the fit of an independent model assuming null correlations between the variables. The CFI varies between 0 and 1 and an acceptable fit is indicated by a CFI > 0.90 (Kline, 2005). Contrarily, the RSMEA (root mean square error of approximation) is a badness-of-fit index as it indicates the approximative model fit, with lower values representing a better fit. The value varies between 0 and 1, and values < .05 indicate a good fit, whereas values < .08 indicate an acceptable fit (Christ & Schlüter, 2012). The confidence interval that is provided by MPlus reports the range that the population RMSEA lays in with a probability of 90%. The SRMR (standardized root mean square residual) provides the mean of the difference between the observed and estimated correlations and also varies between 0 and 1. A value < .08 indicates acceptable fit (Christ & Schlüter, 2012). These guidelines for model fit indices are summarized in Table 2. Information criteria such as the BIC (Bayesian information criterion) can be used to compare the fit of non-nested models, i.e., models that cannot be transformed into one another by proposing model restrictions. This index, therefore, was necessary in study I to compare both models of SRL that assumed differing positions of the volitional factor.

Table 2

*Fit indices and their cut-offs for acceptable model fit*

fit index	cut-off value for acceptable fit
$\chi^2/df$	2:1
CFI	> .90
RMSEA	< .08
SRMR	< .08

*Note.* df = degrees of freedom, CFI = comparative fit index, RMSEA = root mean square error of approximation, SRMR = standardized root mean square residual.

In preparation for latent variable modeling, it is necessary to screen data with regard to missing values and to investigate if these are systematically missing for a specific reason or if they are negligible because they are accidental (Kline, 2005). If the missings of one variable are not systematically related to the observed scores on that variable, the missing is at random (MAR). If the data missing is not related to any other variable, the missing pattern is completely at random (MCAR). Missing patterns can be investigated with Little's MCAR test (Little & Rubin, 2002). Handling missing data can be done by listwise or pairwise deletion, single-imputation models, or model-based imputations (Kline, 2005). As MPlus7 uses the FIML-estimator (full information maximum likelihood) to deal with missing observations, data are not deleted or imputed, but MPlus calculates parameter estimates of available data directly. Besides missing pattern analyses, data should meet the requirement of multivariate normality. As the data in study I did not meet this assumption, the MLR estimator (maximum likelihood robust estimator) was used as it is robust to non-normality of the data.

## 4.2 Study II

The purpose of the second study was to analyze the effects of different interventions to foster SRL in college students. As it was not possible to randomly assign students to the four conditions (no intervention, learning diary, training, learning diary + training), a quasi-experimental design had to be used to realize the 2 (learning diary yes/no) x 2 (training yes/no) x 2 (pretest/posttest) factorial design. Because the preexisting groups that were assigned to the four conditions differed with regard to their baseline SRL values, propensity score matching was used to adjust the subsamples to one another. Such an adjustment is very important as pretest differences between groups “invalidate[s] their posttest difference as treatment effect estimator” (van Breukelen, 2006, p. 921). The propensity score matching procedure is often used in evaluation research (Hughes, Chen, Thoemmes, & Kwok, 2010) because it helps to match participants from the control condition to participants from the treatment condition by selecting subjects with very similar estimated propensity scores (Thoemmes, 2011). This score is defined as the probability of being in the treatment group and uses measured covariates as a base for the calculation. In study II, baseline SRL values were found to differ regarding the factor training yes/no. Therefore, propensity score matching was conducted concerning this treatment factor, and the SRL subscales were used as covariates. The matching process therefore aims to balance propensity scores of treated and untreated participants by creating a balance on the used covariates (SRL subscales). Balancing the covariates that differ in the pretest helps to rule them out as a confounder of the treatment effect. Concordantly, Thoemmes (2011) states that the “balance that a randomized experiment is expected to create by design is here established through statistical matching” (p. 4).

Moreover, the author introduces a four-step procedure to conduct propensity score matching. At first, the researcher has to select pretest covariates that are seen as theoretically important for the research question. As SRL baseline values are strong confounders with

regard to the effectiveness of an SRL intervention (see section 2.3.3 concerning ATI research), SRL subcomponents were selected as covariates. In the second step, these covariates are used to estimate the propensity score by using logistic regression with the treatment group as the dependent variable. Then, SPSS uses this propensity score for nearest neighbor matching so that a single participant from the treatment group is matched to a single participant of the control group with the most similar propensity score. In the last step, the researcher should check if the balance on covariates was achieved through matching by comparing the statistics of the treatment and control group before and after matching.

Thoemmes (2011) developed the program “psmatching”, which is a customer dialog for SPSS that runs all analyses in R using the SPSS R-Plugin. This program allows for several specifications of the matching process: The user can decide whether subjects with propensity scores outside the area of common support (distribution of propensity scores for which units of both treatment and control groups are observed) should be included in the algorithm, although this can deteriorate the balance of covariates. Moreover, the user can decide if units of the control group should be used several times to match units of the treatment group and if the ratio of control units to matched treatment units is 1:1 or 2:1 (useful when group sizes differ and 1:1 matching would discard too many units). Additionally, the user can select a caliper value (maximum distance between two units on their propensity score) for matching. The smaller the caliper, the more similar the matched units are on their covariates. Nevertheless, small calipers will result in fewer matched pairs, which is why increasing the caliper can help to find more matches (that can be slightly imbalanced but similar on covariates as well).

In order to answer the question which intervention method results in the highest increase of SRL values, multivariate ANOVA with SRL subscales as the dependent variable and repeated measurement were used with the matched sample. Recent literature has discussed whether to use ANOVA on gain scores (which leads to adequate results as repeated

measurement ANOVA) or ANCOVA on posttest scores, with pretest scores as covariate to evaluate a treatment (Cribbie & Jamieson, 2004). As Knapp and Schafer (2009) indicate, there is a substantial difference between the research focus that is implied by using gain scores and the focus for which ANCOVA is used. Whereas gain scores help to answer questions such as, “What is the effect of the treatment on the change from pretest to posttest?” (Knapp & Schafer, p. 2), ANCOVA is used to answer questions such as, “What is the effect of the treatment on the posttest that is not predictable from the pretest (i.e., conditional on the pretest)?”. As study II aimed to investigate the effects of different interventions on SRL change, gain scores seem to be the method of choice. A further rationale for this decision is given by van Breukelen (2006), who discusses the use of ANOVA of change and ANCOVA in randomized and non-randomized studies. The author illustrates that both methods are unbiased in randomized studies, and that ANCOVA has more power in this case. With non-randomized studies and pre-existing groups assigned to a treatment (as in study II), ANOVA of change has a more plausible assumption (equal change) than ANCOVA (regression to common mean), and therefore is the superior method. In line with this, Fitzmaurice, Laird, and Ware (2004) recommend the use of gain scores in non-randomized studies to answer the question of how groups differ in change after a treatment.

As study II included a process evaluation of the training program by using learning diaries, time series analyses (Schmitz, 1989) were conducted. This method helps to investigate how a single training session impacts the respective SRL subcomponent (e.g., goal setting, time planning, etc.). Moreover, this type of analysis allows for investigating linear trends that are not intervention based, which is why a comparison of the learning diary group and the combination group (learning diary + training) was possible. In order to conduct process analyses, learning diary data have to be aggregated over persons so that a mean value for each day results (Schmitz, 2009). Using a multiple baseline design (interrupted time series analyses; Tabachnik & Fidell, 2007), changes after each of the six SRL training sessions

could be compared to a baseline phase during which no intervention was conducted. This allows for the investigation of the question of whether changes in trained variables can be significantly predicted by the corresponding treatment. Similar to a t-test, the subcomponent aggregated mean value for the intervention phase is compared to the subcomponent aggregated mean value for the baseline phase (Perels, 2010). It can be assumed that each treatment effect lasts longer than only one session, so a step treatment was modeled in statistical analyses (Tabachnik & Fidell, 2007). With regard to the change in overall SRL regarding the entire intervention period of seven weeks, an additive effect of training sessions was assumed, which is why a ramp treatment variable was modeled in analyses (Schmitz, 2009). As the learning diary itself can act as an intervention to foster self-monitoring and therefore SRL (see section 2.3.2), linear trends were computed with aggregated process data for both the learning diary and the combination group and were compared to disentangle the effects of the learning diary and training. With regard to exploratory analyses, quadratic trends were also computed and were used to interpret the process findings in depth.

### 4.3 Study III

The third study aimed to investigate the presence of SRL profiles in college students and to analyze how these profiles relate to academic achievement, personality, and the effectiveness of an intervention to foster SRL. Latent profile analysis (LPA), which is a special form of latent class cluster analysis (LCCA), was used to determine the number of SRL profiles in college students based on the SRL subcomponents. Cluster analysis is defined as classifying similar participants into groups when the number of groups and their properties are not known a priori (Kaufman & Rousseeuw, 1990). In latent cluster analyses, it is assumed that participants can be grouped into a set of  $k$  latent classes with participants of one class regarded as similar concerning several observed variables. The latent variable is a categorical

variable with  $k$  numbers of clusters, and the value of this latent variable causes the observed values on the indicator variables (Pastor, Barron, Miller, & Davis, 2007).

LCCA therefore represents a model-based clustering approach as a statistical model is proposed for the population. In line with this, the maximum likelihood (ML) parameter estimation is used to create groups of participants that are most dissimilar from one another while the participants within the groups represent homogeneous subpopulations (Vermunt & Magidson, 2002). Whereas LCCA is used with categorical observed variables, one has to use LPA to classify participants based on categorical and continuous observed variables. Accordingly, LCCA and LPA are typed as mixture modeling methods because the underlying population is assumed to be heterogeneous with regard to the interrelation of variables (Masyn, 2013). Both methods, therefore, belong to the class of the person-centered approach as they describe association among individuals (and not associations between variables as in the variable-centered approach). The main difference between factor analysis described in section 4.1 and cluster analysis is that “the common factor model decomposes the covariances to highlight relationships among the variables, whereas the latent profile model decomposes the covariances to highlight relationships among individuals” (Bauer & Curran, 2004, p. 6).

One main advantage of LPA over classical cluster analysis is the availability of statistical fit indices that result from the robust maximum-likelihood estimation approach (MLR) and help to evaluate cluster solutions. Contrary to the predominant use of sample-size independent goodness-of-fit indexes in CFA and SEM, sample-size dependent fit indexes as the BIC represent the standard to interpret LPA solutions (Marsh, Lüdtke, Trautwein, & Morin, 2009). Such information criterion indexes are highly dependent on the sample size as larger samples provide more information and therefore allow for the estimation of more complex models. With regard to model fit, the model with the lowest BIC value indicates the best fit. Besides the BIC, the entropy value is used as decision criterion, and it indicates the certainty of the classifications. This values ranges between 0 and 1 and should be rather high



to indicate reliable classification certainty. Values around .80 are regarded as sufficiently high to assume the proposed classification. Additionally, one can refer to the Lo-Mendell-Rubin test (LMRT) that investigates if a model with  $k$  classes fits the data more adequate than a model with  $k-1$  classes. A significant  $p$ -value indicates a superior fit of the model with  $k$  classes. As Marsh et al. (2009) emphasize, selecting the “right” number of classes cannot be solely based on applying rules of thumb for fit indices. There are no “golden rules” for selecting the best fitting model, but the interpretation of fit indices always has to be paired with decisions on interpretability and parsimony. Oftentimes, there are no hypotheses concerning the number of groups, which is why 1-7 classes are investigated exploratory and interpreted with regard to fit indices, group size, and interpretability.

As another aim of study III was to examine how these profiles interact with an intervention to foster SRL, participants of the training sample had to be classified to the previously found profiles. As the goal of discriminant analysis is the prediction of group membership using a set of predictors (Tabachnick & Fidell, 2013), it is useful to assign the training participants in the profile groups found by using LPA. This can be seen as a form of cross-validation for the classification coefficients found with the cluster sample (that was used to derive the profiles). IBM SPSS discriminant analysis is able to derive classification functions based on the cluster sample and the predictors (SRL subscales) and to include unclassified cases of the training sample into the classification phase. In order to analyze how the profiles impact the effectiveness of an SRL intervention, a repeated measurement ANOVA was used with the profile groups as an independent variable and the SRL value (for pre- and posttest) as a dependent variable.

## 5 Overview of Studies

To pursue the overall aim of modeling and fostering SRL in college students including a differential perspective, three separate studies were conducted. The first study developed and

evaluated an SRL trait model that integrates volitional components in addition to cognitive, metacognitive, and motivational components and therefore belongs to the modeling part of the thesis. The second study introduces the fostering part of the thesis and analyzed how to support SRL most effectively in college. To this end, the usefulness of an active SRL training, a structured learning diary that should enhance self-monitoring, and the combination of both methods was investigated. Adopting a person-centered approach, the third study made up the differential part and analyzed the presence of different SRL profiles in college students. Their relation to achievement levels and personality structure as well as their influence on the effects of the abovementioned SRL training were examined.

## 5.1 Study I

Dörrenbächer, L. & Perels, F. (2015). Volition completes the puzzle: Development and evaluation of an integrative trait model of self-regulated learning. *Frontline Learning Research*, 3(4), 14-36. <http://dx.doi.org/10.14786/flr.v3i4.179>

This study aimed to develop and evaluate a trait model of self-regulated learning that integrates cognitive, metacognitive, motivational as well as volitional components.

### *Abstract*

Most self-regulated learning theories are imbedded within a social-cognitive framework and comprise cognitive, metacognitive, and motivational components. Nevertheless, these theories partly neglect volition, which is necessary for implementing learning intentions. Therefore, the present study is frontline as it aimed to integrate volition within a comprehensive trait

model of self-regulated learning (SRL) while proposing a new conception of trait volition for learning. A sample of  $n = 377$  college students (70.1% female,  $M_{\text{Age}} = 23.36$ ,  $SD_{\text{Age}} = 4.12$ ) filled out questionnaires concerning volitional, cognitive, metacognitive, and motivational belief aspects of SRL. The results of confirmatory factor analysis speak in favour of integrating the highly interrelated constructs of procrastination, future time perspective, and academic delay of gratification in order to depict volition for SRL. Moreover, the structural equation modelling results favour a twofold motivational component for SRL that comprises both motivational beliefs and volition instead of including volition as a separate component aside from cognitive, metacognitive, and motivational belief components. Additionally, the comprehensive trait model of SRL is related to GPA, which is a first indication of its validity. Therefore, the study empirically investigates a new conception of trait volition for learning environments as well as its integration within a comprehensive SRL framework. Future research should consider the importance of volitional components for SRL and could investigate individual differences concerning the modelled components.

### 5.1.1 Theoretical background and aims

SRL can be conceptualized as a stable trait or as a dynamic state (Winne & Perry, 2000). Although state models of SRL have mostly been promoted in recent research, trait models of SRL are important as well as they help to explain individual differences in SRL (Hong & O'Neil, 2001). Trait SRL is then seen as a learning disposition that influences the uses of SRL strategies independent of situational factors (Boekaerts & Corno, 2005) and therefore has an influence on academic achievement. Hong and O'Neil (2001) proposed a trait model that treats SRL as a third-order factor superordinate to metacognition and motivation as second-order factors. The metacognitive factor in turn subsumes the present-order factors of planning and self-checking, whereas the motivational factor includes the present-order factors of self-efficacy and effort. Although the model was validated by factor analysis, it has several

noticeable shortcomings. First, there is no second-order cognitive factor integrated despite the fact that cognition represents an important SRL component category besides motivation and metacognition (Boekaerts, 1999). Moreover, the model simplifies the motivational and metacognitive factors as they are only represented by two first-order factors each.

Although the trait model of Hong and O'Neil (2001) integrates a volitional factor (effort), this conceptualization is very limited for the context of SRL. Volition is defined as the capability to protect learning intentions by inhibiting irrelevant behaviors and thus is very important with regard to learning environments (Corno, 2001; Duckworth & Seligman, 2006). As the construct stems from action-control theory (Kuhl, 1984), it has rarely been integrated into the social-cognitive perspective of SRL (Garcia et al., 1998). Nevertheless, several authors argue for a stronger integration of volitional aspects within SRL theories (Duckworth et al., 2014). With regard to this demand, it is unclear whether volition is a separate aspect of SRL in addition to cognition, metacognition, and motivational beliefs (Corno, 2001) or if it is part of a broader motivational trait that incorporates motivational beliefs and volitional aspects (Zimmerman, 2008). As action-control theory differentiates between choice motivation (motivational beliefs) that is necessary in the pre-decisional phase of learning and executive motivation (volitional aspects) that is crucial for the post-decisional phase, a broader motivational trait that subsumes motivational beliefs and volition is hypothesized.

Concerning learning environments, three traits have turned out to be especially important to protect learning intentions from distractions. Academic delay of gratification is described as the ability to postpone impulsive actions in order to protect distant and valuable academic goals (Bembenutty, 2008) and positively influences academic achievement (DiBenedetto & Bembenutty, 2103). Future time perspective is a cognitive-motivational concept that supports future-oriented beliefs and helps to assess the value of future goals (Peetsma, Schuitema, & van der Veen, 2012). This trait improves study outcomes (Horstmanshof & Zimitat, 2007) and the use of other SRL strategies (Zimmerman, 2011).

Procrastination is the tendency to delay planned actions despite their relevance for the attainment of important academic goals (Steel, 2007). It therefore is on the opposite end of the volitional continuum (Park & Sperling, 2012) and represents a trait with a negative influence on academic achievement (Akinsola, Tella & Tella, 2007). As these constructs are highly interrelated (Sirois, 2014), different authors speak in favor of integrating them to represent a higher-order volitional trait for learning (Bembenuddy & Karabenick, 2004; Dewitte & Lens, 2000).

In conclusion, the first study aimed to develop a trait model of SRL that integrates cognitive, metacognitive, motivational, and volitional factors. As volition can be conceptualized as a distinct factor (Corno, 2001) or as part of a broader motivational factor (Zimmerman, 2008), the study aimed to clarify the role of volition within an SRL framework. Moreover, the study evaluated a new conception of volition for learning environments by integrating academic delay of gratification, future time perspective, and procrastination.

### 5.1.2 Methods

A sample of  $n = 377$  undergraduate students (70.1% female,  $M_{Age} = 23.36$ ,  $SD = 4.12$ ) with different subjects of study participated in the study. Testing took place in the first session of several university courses, and the students were asked for the GPA of their university entrance diploma. They also filled out an SRL inventory that comprised 32 items belonging to cognitive, metacognitive, or motivational belief subscales. Items were adopted from existing instruments (e.g., Jerusalem & Schwarzer, 1981; Pintrich, Smith, Garcia, & McKeachie, 1991; Wild & Schiefele, 1994). Cronbach's alpha was satisfying for all subscales and confirmatory factor analyses confirmed the structure of the SRL inventory. Moreover, participants answered 14 items of a volition inventory that represented the subscales of academic delay of gratification, future time perspective, and procrastination. Cronbach's alphas were satisfying for these subscales as well. Data analysis was conducted with MPlus7

(Muthén & Muthén, 2012) and comprised confirmatory factor analysis for the evaluation of the newly developed volition inventory as well as for the comparison of both SRL models. Structural equation modeling was used to investigate the relationship of trait SRL with academic achievement as a first hint for criterion validity of the newly developed model.

### 5.1.3 Results

In the first step, the structure of the volition inventory was investigated by using confirmatory factor analysis. The results showed a good model fit for our proposed model of second-order volition that comprised three first-order factors of academic delay of gratification, future time perspective, and procrastination ( $\chi^2 (75) = 123.12, p < .01, \chi^2/df = 1.64, RMSEA = 0.041 [0.028 - 0.054], SRMR = 0.039, CFI = 0.971$ ). With regard to the integrative trait model, a comparison of model fit indices and BIC values lead to the conclusion that a third-order SRL model comprising three second-order factors of cognition, metacognition, and motivation (with motivation combining motivational beliefs and volition) fits the data more adequately ( $\chi^2 (31) = 45.11, p < .01, \chi^2/df = 1.46, RMSEA = 0.035 [0.003 - 0.056], SRMR = 0.035, CFI = 0.987$ ). The model is shown in Figure 9. Structural equation modeling was used to investigate the relationship of third-order SRL with the GPA of university entrance diplomas and showed good model fit ( $\chi^2 (41) = 63.75, p < .01, \chi^2/df = 1.55, RMSEA = 0.038 [0.018 - 0.056], SRMR = 0.041, CFI = 0.981$ ). A highly significant correlation of medium size between SRL and GPA was found ( $r = -.23, p < .001$ ; grades are reverse coded in Germany, which is why higher grades represent weaker achievement) and can be interpreted as a first hint for criterion validity of the supposed model.

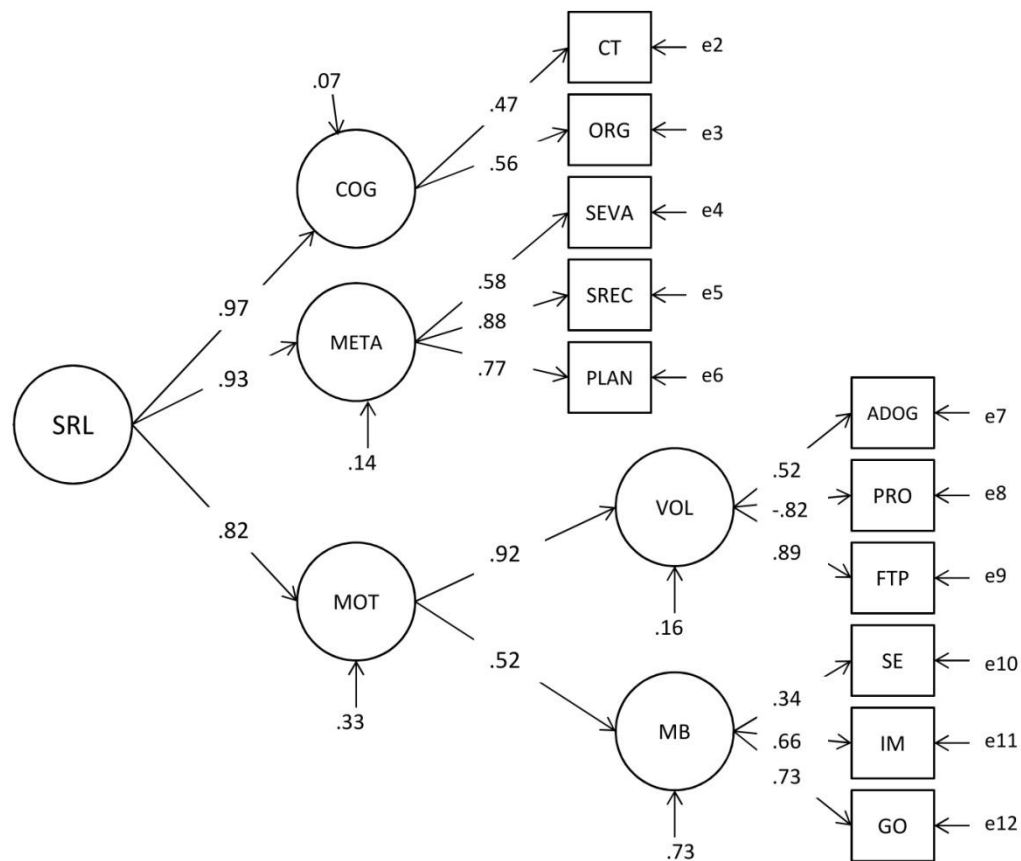

Figure 8. Trait model of self-regulated learning (Dörrenbächer & Perels, 2015). *SRL* self-regulated learning, *COG* cognitive components, *CT* critical thinking, *ORG* organization, *META* metacognitive components, *SEVA* self-evaluation, *SREC* self-recording, *PLAN* planning, *MOT* motivational components, *VOL* volition, *ADOG* academic delay of gratification, *PRO* procrastination, *FTP* future time perspective, *MB* motivational beliefs, *SE* self-efficacy, *IM* intrinsic motivation, *GO* goal orientation. All factor loadings are significant ( $p < .001$ ).

#### 5.1.4 Discussion

The overall aim of the first study was to develop and evaluate an integrative trait model of SRL. In this context, a new conceptualization for volition within learning environments was developed by integrating future time perspective, academic delay of gratification, and procrastination. The results support the assumption that these three traits are useful to

represent volition for learning environments. Results concerning the trait model of SRL speak in favor of integrating volition in the framework of SRL; SRL can be conceptualized as a third-order factor that subsumes the three second-order factors of cognition, metacognition, and motivation. Motivation in turn subsumes the two factors of motivational beliefs and volition. This is in line with action-control theory (Kuhl, 1984) that assumes a motivation dichotomy combining choice motivation (motivational beliefs) and executive motivation (volition). The relationship of the newly developed integrative SRL model with academic achievement emphasizes the construct's relevance for (college) learning.

Although the hypothesized models of trait volition and trait SRL as well as its relationship with academic achievement were confirmed, there are several limitations that have to be mentioned. As the GPA of university entrance diplomas was used as an achievement marker, it is kind of retrospective. Nevertheless, this measure is comparable across all students, which would not be the case for the GPA of current subjects of study (Müller-Benedict & Tsarouha, 2011). Moreover, the sample used was highly heterogeneous and contained a higher number of females than males. This could lead to distortions in results. Nevertheless, the relationship found in the study gains importance with regard to this heterogeneity and underlines SRL's relevance to all subjects of study.

Future research should acknowledge the importance of volition within the framework for SRL and could use the newly developed conceptualization of volition for learning. Validating the models with groups of different age and educational level could lead to new insights on their generalization. Longitudinal research to investigate the model's stability and predictive power for future achievement is also of special interest. In addition, it would be necessary to investigate the model by using more objective instruments than self-report questionnaires (interviews, thinking aloud protocols; Veenman, 2011). With regard to the state-trait debate of SRL, it would be very interesting to know if the proposed model structure can be confirmed with state data resulting of process measures (Hong, 1998).



## 5.2 Study II

Dörrenbächer, L. & Perels, F. (2016). More is more? Evaluation of Interventions to Foster Self-Regulated Learning in College. *International Journal of Educational Research*, 78, 50-65. <http://dx.doi.org/10.1016/j.ijer.2016.05.010>

This study aimed to disentangle the effects of content-independent SRL training, a learning diary to foster self-monitoring, and their combination on college students' SRL.

### *Abstract*

As self-regulated learning (SRL) is crucial for postsecondary academic success, the present study aimed to investigate how to foster this ability most effectively in college. Based on a 2 x 2 x 2 control-group design, we analyzed effects of a content-independent SRL training, a learning diary, and their combination, which was hypothesized to be most effective. Pre-post and process measures of SRL, and an academic transfer measure, were used to evaluate intervention effects in 173 college students. Results indicated that the training positively influenced SRL, whereas the learning diary alone had no effects. The combination of both interventions produced the highest effect. Although effects were stable for eight weeks, no transfer effects were found. Practical implications can be deduced based on the present findings.

### 5.2.1 Theoretical background and aims

As SRL is positively related to the academic achievement (Kitsantas, 2002; Nandagopal & Ericsson, 2012) and well-being (Park et al., 2012) of college students, it is seen as a highly relevant component of successful college learning (Bemebnutty, 2011b). Nevertheless, most college students lack the competence to self-regulate their learning (Peverly et al., 2003). They are often not able to estimate their knowledge adequately, and an overestimation of

knowledge tends to result in underachievement (Dunlosky & Rawson, 2012). In order to correct such inadequate self-estimation and to optimize the use of SRL strategies, trainings that teach SRL strategy knowledge and practice have proved useful (e.g., Masui & De Corte, 2005; Reeves & Stich, 2011) and can result in long-lasting effects on academic achievement (Bail et al., 2008).

Nevertheless, most training programs focus on a few specific SRL strategies instead of providing a holistic framework. Moreover, training programs are often tied to specific content (e.g., psychology and statistics, Wagner et al., 2010) and therefore cannot be used ubiquitously with all groups of students. As content-independent trainings can result in positive effects as well (e.g., Hofer & Yu, 2003), they are of special importance to the college environment because of their economic benefits. Therefore, the first aim of the second study was to develop a content-independent training based on the theoretical framework of Zimmerman (2000) and provides students with a holistic framework of SRL (Cleary et al., 2008). The training aims to include strategies of all three phases of SRL (Zimmerman, 2000) and of all three categories of SRL (motivation, metacognition, cognition; Boekaerts, 1999).

Another way to foster SRL is through an increase in self-monitoring activities (Schmitz & Wiese, 2006). Self-monitoring comprises the deliberate attention to specific behavioral aspects (Lan, 1996) and therefore helps to optimize learning by unraveling discrepancies from a planned performance. It is a highly relevant component of the performance phase of Zimmerman's SRL model (2000) and is positively related to the use of other SRL strategies (Lan, 1996) and learning results (Hartwig, Was, Isaacson, & Dunlosky, 2012). Nevertheless, college students use self-monitoring strategies very rarely (Lan, 2005). In the SRL context, standardized learning diaries have proved useful to support self-monitoring of learning (Schmitz & Wiese, 2006). They comprise daily questionnaires with SRL items on forethought, performance, and reflection phases and have to be answered before and after learning. They therefore represent a self-instructional tool that supports reflection of the

learning process (Klug et al., 2011) and can be used as intervention method to foster SRL. Moreover, it can be hypothesized that learning diaries support SRL trainings and can boost their effects when used in combination (Schmitz & Wiese, 2006). They stimulate strategy use and metacognitive thoughts and thus can be regarded as deliberate practice of newly-learned strategies (Schmitz et al., 2011).

As previous results concerning the effectiveness of learning diaries without further interventions remain ambiguous (Dignath-van Ewijk et al., 2015; Fabriz et al., 2014), an additional aim of the study was to investigate the single effects of the newly-developed content-independent training, a learning diary, as well as the combination of these two. With regard to the additive effects hypothesis concerning the combination of SRL training and a learning diary (Schmitz & Wiese, 2006), it was hypothesized that the combination should result in the highest effect on SRL. Stability of effects as well as transfer to an academic task were analyzed as well.

### 5.2.2 Methods

In order to disentangle the effects of training, a learning diary, and their combination, a 2 x 2 x 2 factorial control-group design with training (yes/no) and learning diary (yes/no) as between-subject factors and time (pretest/posttest) as a within-subject factor was applied. To realize the factorial combinations, preexisting groups had to be used because random group assignment was not possible. All participants were tested at the beginning of the semester (t1) and eight weeks later (t2). The control group (CG) received no intervention during that time, whereas the learning diary group (LG) had to complete learning diaries. The training group (TG) participated in the newly-developed training program, whereas students in the combination group (LTG) additionally filled out the learning diary. Both training groups were tested eight weeks after the training ended for stability measurement (t3).

A sample of  $n = 244$  students of different subjects of study participated in both the pre- and posttest. As there were pretest values on SRL subscales between the groups with and without training, propensity score matching (Thoemmes, 2011) was used to match students in the training groups (TG, LTG) with their most similar students in the non-training groups (CG, LG). This algorithm resulted in a final sample of  $n = 173$  participants (72% female,  $M_{\text{Age}} = 22.94$ ,  $SD = 4.10$ ) that were distributed relatively homogeneously to the single groups ( $n_{\text{CG}} = 47$ ,  $n_{\text{LG}} = 44$ ,  $n_{\text{TG}} = 55$ ,  $n_{\text{LTG}} = 27$ ).

The SRL training comprised eight weekly sessions of about 90 minutes each that were held by a trainer and co-trainer and that were standardized by a schedule as well as a similar structure. The sessions comprised theoretical input from the trainer and single or group exercises based on standardized worksheets. Each training session treated a different component of the SRL cycle (Zimmerman, 2000). Whereas the first sessions included strategies of the forethought phase (goal-setting, planning, self-motivation), the subsequent sessions treated performance strategies (volition, attention focusing, task strategies), and strategies of the reflection phase (self-evaluation, attribution). The self-monitoring intervention was a standardized learning diary that comprised items on forethought, performance, and reflection phases of learning and had to be filled out daily.

For pre-post evaluation of intervention effects, an SRL questionnaire and an academic task were used. The SRL questionnaire comprised 54 items reflecting forethought, performance, and reflection phases (Zimmerman, 2000) and showed satisfying internal consistencies for all subscales and both measurement points. The academic task was a working efficiency test (Conzelmann & Kersting, 2012) that measured the effective completion of sorting tasks and requires planning as well as strategy development and concentration. The authors report adequate difficulty (0.73) and acceptable reliability values (0.77 – 0.93). Therefore, it seemed adequate as a transfer measure for SRL training. In addition to pre-post evaluation, training effects were investigated through process evaluation.

As the learning diary comprises daily questionnaires, data changes can be analyzed with (interrupted) time series analyses. The diary comprised 47 items for each day that showed good internal consistencies and satisfying stability.

### 5.2.3 Results

A multivariate analysis of variance with the training and learning diary as between-subject factors, time as a within-subject factor, and SRL subscales as dependent variables revealed a significant two-way interaction of time x training ( $F(12, 158) = 2.16, p < .05, \eta_p^2 = .14, d = .80$ ) and a significant two-way interaction of time x learning diary ( $F(12, 158) = 1.85, p < .05, \eta_p^2 = .12, d = .74$ ). The interactions were in the hypothesized directions as the intervention groups showed higher gains in SRL than the control group. Moreover, analyses resulted in a significant three-way interaction of time x training x learning diary ( $F(12, 158) = 2.04, p < .05, \eta_p^2 = .13, d = .77$ ) and three contrasts were used to specify this interaction. They revealed that all intervention groups showed higher gains than the control group and that the single interventions did not differ from each other concerning gains in SRL. With regard to the additive effects hypothesis, it was revealed that the combination group showed higher gains than both single intervention groups. Analyses concerning the follow-up test showed that TG could significantly gain in SRL from t2 to t3 ( $t(41) = -2.77, p < .05, d = 0.39$ ), whereas SRL remained stable in LTG from t2 to t3. Concerning the work efficiency test, no transfer effects were found as all groups showed similar changes from t1 to t2.

As a further evaluation of the content-independent training program, interrupted time-series analyses were conducted to detect session-induced changes in SRL. This multiple baseline design can only be used for the combination group as they filled out learning diaries in addition to SRL training. The analyses revealed significant intervention effects for the subscales of goal attainment, time planning, decision-making, self-motivation, self-efficacy, and volition. In order to compare the combination group (LTG) with the diary-only group

(LG), process data were used to perform trend analyses. They helped to uncover time-related increases in SRL data. Whereas there was only one positive linear trend in LG for the subscale of learning strategies, there were several positive linear trends in LTG (goal setting, planning, self-efficacy, learning strategies, volitional control, and adaptive self-reaction).

#### 5.2.4 Discussion

The second study aimed to investigate how to foster SRL most effectively in college students by comparing the effects of a content-independent training program, a learning diary as a method to foster self-monitoring, and their combination. The results underline the positive effect of the training program on students' SRL and are in agreement with previous results on the effectiveness of content-independent trainings (e.g., Hofer & Yu, 2003). The training effect even increased from post- to follow-up test and was confirmed by process data, speaking in favor of the usefulness of a training program that provides students with a holistic SRL framework and fosters components of all phases of learning (Zimmerman, 2008).

Using the learning diary as a single intervention seems to have no significant effect on students' SRL as they did not increase significantly on the pre-post level and even showed declines in some of the process measures. This is in line with the results of Fabriz et al. (2014), who also found no effect of learning diaries if they are not combined with training. This result emphasizes the importance of anchoring self-monitoring interventions within a broader SRL framework so that students get information about the usefulness of the intervention (Zimmerman & Paulsen, 1995). Self-monitoring of unsuccessful learning behavior without being provided with strategies to overcome these problems can result in demotivating effects and can explain the negative effects found for the present intervention. In line with the additive effect hypothesis, the combination of training and a learning diary resulted in the highest effect on students' SRL, supporting the assumption that learning diaries boost training effects (Schmitz et al., 2011). Nevertheless, transfer effects were not found and

it can be hypothesized that the working efficiency test does not necessitate SRL strategies, therefore it is not appropriate to measure an increase in SRL.

Despite the confirmation of the hypothesized effect pattern, there are several limitations that have to be mentioned. As SRL only was assessed via self-report measures, data could be contorted through problems of generalization and retention (Winne & Perry, 2000). As self-reports often do not reflect actual behavior, future studies should aim to overcome these problems by using more objective measurements such as thinking aloud protocols (Veenman, 2011). Additionally, it would be desirable to repeat the investigation by examining randomly assigned participants and by obtaining information on a content-independent transfer measure that reflects SRL abilities. Despite these limitations, the second study adds to the research as it underlines the importance of providing a theoretical framework when using learning diaries, and that this framework can most effectively be introduced by also conducting an SRL training.

### 5.3 Study III

Dörrenbächer, L. & Perels, F. (in press). Self-regulated learning profiles in college students: Their relation to achievement, personality, and the effectiveness of an intervention to foster self-regulated learning. *Learning and Individual Differences*.  
<http://dx.doi.org/10.1016/j.lindif.2016.09.015>

This study aimed to investigate the presence of SRL profiles in college students and to analyze the profiles' relation to achievement and personality. Moreover, how these profiles influenced the effectiveness of an SRL training program was also investigated.

*Abstract*

Self-regulated learning (SRL) is highly relevant for postsecondary academic success. Nevertheless, individual differences in SRL are found and can influence SRL training results. Conducting latent profile analyses with  $n = 337$  college students, we found four SRL profiles that differed quantitatively and with regard to motivational subcomponents. Achievement was significantly higher for students with high SRL and high motivation. Moreover, the profiles differed with regard to personality as more competent self-regulators showed lower test anxiety, lower neuroticism, and higher values in extraversion, conscientiousness, agreeableness, and openness to experiences. Using a sample of  $n = 55$  students who participated in an eight-week SRL training, we investigated differential effects of the SRL profiles. Students with moderate and motivated SRL profiles benefited from the intervention, whereas students with low and high SRL profiles did not. The results speak in favor of developing adaptive training programs depending on SRL profiles.

### 5.3.1 Theoretical background and aims

Numerous studies underline the relevance of SRL in the college environment (e.g., Bembenuddy, 2011b) and show that this competence can be fostered through strategy training (e.g., Bail et al., 2008). Nevertheless, several authors have asked for an investigation of interindividual factors that are related to SRL (Zeidner et al., 2000). One interesting variable in this context is academic achievement. High achieving students use more SRL strategies when preparing for exams (Kitsantas, 2002) and use more strategies that are different from each other (Nandagopal & Ericsson, 2012). Moreover, metacognitive abilities and an adaptive use of SRL strategies in general are related to higher academic achievement (e.g., Hacker et al., 2000; Liu et al., 2014). Besides achievement, SRL is related to personality factors: Bidjerano and Dai (2007) reported that conscientiousness and openness to experience are positively related to SRL strategies (e.g., Chamorro-Premuzic & Furnham, 2003; Busato,



Prins, Elshout, & Hamaker, 1999), whereas the findings for agreeableness and extraversion are not that distinct as these traits are rarely investigated in the context of SRL (Eilam et al., 2009; Matthews, 1997). In contrast, neuroticism and test anxiety have an unambiguous negative relation to learning skills and academic outcomes (Bidjerano & Dai, 2007; Kesici et al., 2011).

Following a person-centered approach (Bergman et al., 2003), previous research has shown the presence of SRL profiles that are either adaptive or maladaptive for learning (Barnard-Brak et al., 2010; Liu et al., 2014; Valle et al., 2008) but remain unclear on the number of profiles. Moreover, relations of these profiles with personality factors have not been investigated before. Therefore, the third study aimed to examine the presence of SRL profiles in college students and to relate them to achievement and personality to gain new insights into individual differences in SRL. Moreover, it can be hypothesized that SRL profiles influence the effectiveness of programs to foster SRL and that these individual differences result in aptitude-treatment-interactions (Snow, 1992). Although such individual training effects have to date been rarely investigated within the framework of SRL, some studies speak in favor of compensation effects (Gonzalez-Pienda et al., 2014). Therefore, the second aim of the study was to investigate differential effects of an SRL training depending on the previously found SRL profiles.

### 5.3.2 Methods

As the first aim of the study was to investigate the presence of SRL profiles and to analyze how they differ in regard to achievement level and personality,  $n = 377$  college students ( $M_{Age} = 23.48$ ,  $SD = 4.08$ , 71% female) of different subjects filled out questionnaires that asked for the GPA of the university entrance diploma, the current GPA of the subject of study, personality factors, and SRL (cluster sample). The Big Five personality dimensions were registered through four items each and showed acceptable internal consistencies (Rammstedt

& John, 2005). Test anxiety was assessed by nine items of the Test Anxiety Inventory (Spielberger, 1980) and showed good internal consistency. The SRL inventory comprised 49 items that represented 11 subscales with good internal consistencies. Both the structure of the personality questionnaire and the SRL questionnaire was confirmed by confirmatory factor analysis. Based on these data, it was possible to conduct latent profile analyses to cluster participants into SRL profiles and to analyze their relation to achievement level personality factors.

In order to investigate differential effects of the SRL profiles within an SRL training program,  $n = 69$  college students ( $M_{Age} = 22.01$ ,  $SD = 3.66$ , 73% female) of different subjects participated in an eight week content-independent SRL training (training sample). Participants filled out the same questionnaires as those of the cluster sample before training (t1), directly after training (t2) and eight weeks after the end of the training (t3). Data of  $n = 55$  students were obtained for t1 and t2 and data of  $n = 41$  students were obtained for t1, t2, and t3. Dropout analyses showed that both samples did not differ from the original sample concerning central variables. The SRL training comprised theoretical input as well as exercises to practice newly acquired SRL strategies and treated all phases of an SRL cycle (Zimmerman, 2000; for evidence concerning the general effectiveness of the training see study II). Discriminant analysis based on the results of the profile analysis from the cluster sample was used to classify participants of the training sample into SRL profiles.

### 5.3.3 Results

Latent profile analyses with the cluster sample resulted in four SRL profiles. The first profile was named the low SRL with moderate motivation group as its members showed low values on all SRL subscales and moderate values on motivational subscales (self-efficacy, intrinsic motivation, goal orientation). The second group was named the moderate SRL group as participants in this group showed moderate values on all subscales. The third group showed

moderate values on most subscales with high values on motivational subscales (self-efficacy, intrinsic motivation, goal orientation), and low values on time planning, procrastination (reverse coded), and self-evaluation. Therefore, this group was named the conflicting SRL with high motivation group. The fourth group showed high values on all SRL subscales and therefore was named the high SRL group. The GPA of the university entrance diploma and the GPA of the subject of study varied with regard to the SRL profiles, with students of more skilled profiles (third and fourth group) showing higher grades. Concerning personality, more skilled SRL profiles were accompanied by lower values in test anxiety and neuroticism, and higher values in extraversion, agreeableness, conscientiousness, and openness to experiences.

Using discriminant analysis, participants of the training sample could be classified concerning the newly established groups. A 2 x 4 (Time x SRL profile) repeated measurement ANOVA with SRL as the dependent variable and group membership as the independent variable resulted in a significant interaction ( $F(3, 51) = 5.06, p < .01, \eta_p^2 = .23$ ). T-tests for matched samples revealed a marginally significant increase for the low SRL with moderate motivation group from T1 to T2 ( $t(8) = -2.36, p = .05$ ), and significant increases for the moderate SRL group ( $t(23) = -3.78, p < .003, d = 0.77$ ) and the conflicting SRL with high motivation group ( $t(11) = -5.01, p < .0003, d = 1.42$ ) from T1 to T2. Effect sizes reveal that the increase was strongest for the conflicting SRL with moderate motivation group from T1 to T2. The high SRL group could not improve. Concerning T3, all results were stable as no group showed a significant change from T2 to T3.

#### 5.3.4 Discussion

The third study investigated the presence of SRL profiles in college students and their relation to achievement level and personality structure. It was also analyzed how these SRL profiles influence the effectiveness of an SRL training. Results indicate that there are four SRL profiles that differ quantitatively and with regard to motivational subcomponents. Students of

more skilled profiles show higher achievement levels and more adaptive personality profiles. This is in line with previous research showing a positive relationship of achievement and SRL (e.g., Liu et al., 2014) and of conscientiousness and SRL (Chamorro-Premuzic & Furnham, 2003), but a negative relationship of neuroticism and learning abilities (Bidjerano & Dai, 2007).

Differential effects of the SRL training were found for SRL profiles as only students with moderate SRL skills and conflicting SRL but high motivation could benefit from training, whereas high SRL students showed no further increase. This is in accordance to previous findings (Gonzalez-Pienda et al., 2014) and hints at a compensation effect (Klauer, 1993). Nevertheless, as the conflicting SRL with high motivation group showed the highest effect size, it can be hypothesized that it is advantageous if some SRL skills are present, as these support the optimization of additional SRL skills. Moreover, motivational subcomponents seem to play a crucial role with regard to training benefits as the moderate SRL group, which is less motivated than the conflicting SRL with high motivation group, shows a smaller increase. Whereas students with low SRL abilities are in need of highly intensive support to improve SRL (Kalyuga, 2007), high SRL may benefit more from relatively independent and less structured trainings than the one conducted in the study (Fyfe, Rittle-Johnson, & DeCaro, 2012).

The third study offered some new insights into individual differences in the context of SRL. Nevertheless, there are some limitations that should be tackled in future research. First, larger training sample size would have resulted in a higher power of analyses and would have allowed for investigating the effects of SRL profiles in combination with personality. Moreover, as SRL was only recorded with self-report data, future studies should use more objective measures such as trace data in combination with questionnaires (Veenman, 2011). Additionally, it would be desirable to get information on transfer measures of training. Future studies should also aim to collect longitudinal data on the relationship of achievement as well

as personality and the development of SRL in order to draw conclusions on the direction of effects. In general, it should be acknowledged that there are different groups of college students that benefit unequally from SRL training. Developing adaptive trainings with the possibility to stress various key aspects could be helpful for all groups of students.

## 6 General Discussion

### 6.1 Discussion of Findings

This dissertation aimed to model and to foster SRL in college students by including a differential perspective. A trait model of SRL for college students was developed and how this cross-curricular competence can be fostered most effectively within this target group was investigated. Moreover, the dissertation investigated whether there are individual differences in SRL and examined how these are related to achievement, personality, and the effectiveness of an SRL intervention. The results concerning these three research aims are discussed separately. The summary of findings and their theoretical integration is followed by an in-depth reflection on limitations concerning the design of the studies and the instruments used. In the last part, the results are interpreted with regard to practical implications and future research questions.

#### 6.1.1 Trait-Model for Self-Regulated Learning

As SRL research has largely underemphasized volitional aspects of learning, the first study aimed to integrate a volitional perspective within a trait model of SRL. Therefore, in a first step, a new conception of volition within learning environments was presented. Results indicate that a model of trait volition that integrates academic delay of gratification, reverse procrastination, and future time perspective yields good fit indices. Therefore, it can be assumed that volition within learning environments necessitates the competence of postponing pleasant situations or gratifications in order to achieve a higher-order goal as well

as the knowledge about the importance of future-directed goals. Moreover, highly volitional learners are able to prevent the delay of important actions and to realize their planned actions promptly, even if they are unpleasant. As Bembenutty and Karabenick (2004) proposed a high interrelation of academic delay of gratification, future time perspective, and procrastination, this finding provides an empirical base to support their assumptions.

In a second step, this newly conceptualized volitional trait was integrated within a broader SRL trait model. As trait models of SRL are rarely examined empirically, the model of Hong and O'Neil (2001) was used as a starting point. Their model was extended based on theoretical assumptions concerning the structure of SRL (Boekaerts, 1999; Zimmerman, 2011). Besides a cognitive factor that comprises organization and elaborative learning strategies, the motivational and metacognitive factors were specified by adding several important subcomponents. To determine where to place the newly conceptualized volitional component, two models were compared: one model integrated the volitional component as a separate factor besides motivation, cognition, and metacognition, whereas the second model proposed a motivational factor that is compounded by a motivational beliefs factor and a volition factor. Statistical modeling results indicated that the second model fit the data more adequately. This twofold motivational component is in line with action-control theory (Kuhl, 1984), which differentiates between choice motivation and executive motivation. The result is of high importance because the model connects social-cognitive SRL theory with action-control theory for the first time (Garcia et al., 1998). With regard to Zimmerman's process model of SRL (2000), choice motivation would be important during the planning phase of learning as it comprises self-efficacy, intrinsic value, and goal orientation and therefore influences goal setting. Executive motivation that is represented by the volitional factor could be placed in the performance phase of SRL as it supports the implementation of planned intentions and the realization of previously set goals. The validity of the second model is underpinned by a significant relation to academic achievement.

Although the second model is in line with action-control theory, it is obvious that the volitional factor has a higher loading than the motivational beliefs factor on the motivational second-order factor. One explanation is that both motivational components are highly interrelated but must be used in different phases of learning to be supportive. Accordingly, Wolters (2003b) proposes a curvilinear relationship of motivational beliefs and volition, as only medium levels of motivational beliefs support the use of volitional strategies. Students with a very low motivation lack the intention to use volitional strategies, whereas highly motivated students do not need volitional strategies to support their learning processes. Accordingly, Boekaerts (1999) assumes that positive motivational beliefs support forming learning intentions but that low motivational values can be compensated for by using of volitional strategies. This is in line with Kuhl's (1984) argument that specific goal intentions formulated during the pre-decisional phase do not always cause intention implementation. This lack of clarity could be resolved by conducting longitudinal studies that investigate the development of motivational beliefs and volitional capacities and examine if there's a change in the direction or strength of their interconnection.

In conclusion, it can be said that trait volition for learning comprises academic delay of gratification, reverse procrastination, and future time perspective and that volition represents a highly important competence for SRL. Within a trait model of SRL, volition seems to be connected to motivational beliefs, whereas both factors seem to build up a second-order motivational factor.

### 6.1.2 Fostering Self-Regulated Learning in College

College students often show a deficiency in the knowledge and use of SRL strategies (Peverley et al., 2003). Therefore, the second study aimed to investigate how SRL can be fostered most effectively in college students by comparing the results of a content-independent training, a learning diary to foster self-monitoring, and their combination.

Concerning the SRL training, positive effects were found longitudinally using questionnaire data and on the process level investigating learning diary data. This finding is in line with previous results indicating the effectiveness of content-independent SRL trainings that can be used ubiquitously with all groups of college students (e.g., Hofer & Yu, 2003; Reeves & Stich, 2011). Additionally, conducting content-independent trainings was demanded by several authors (e.g., Schober et al., 2015) as they can easily be integrated in college curricula. Moreover, results indicate that basing training programs on comprehensive theoretical frameworks (as in this thesis Zimmerman, 2000) leads to positive intervention results. The evaluated training program integrates SRL strategies of all three phases of the SRL cycle and therefore provides a metacognitive framework that participants could use to assess the strategies learned in training (Zimmerman, 2008).

With regard to the effectiveness of learning diaries without further training, study II revealed no change based on longitudinal questionnaire data and even a decrease of several subcomponents based on process data. This is in line with Fabriz et al. (2014) and Bellhäuser et al. (2016), who found no effect of learning diaries without further intervention. Nevertheless, the finding is contrary to the self-monitoring hypothesis that assumes a positive effect on SRL due to deliberate self-observations (reactivity effect; Korotitsch & Nelson-Gray, 1996). As some studies found a positive effect of learning diaries alone (e.g., Landmann et al., 2005; Schmitz & Perels, 2011), one has to question the comparability of their formats. Concerning the study of Dignath-van Ewijk et al. (2015), who also found positive changes due to a learning diary, it is obvious that their diary was not a mere self-reflection tool but incorporated strategy instructions. This instructional support provides information on the benefit of self-monitoring and SRL strategies. As Zimmerman and Paulsen (1995) explain, a comprehensive SRL framework should always be imparted in addition to self-monitoring interventions. Students filling out reflection-supporting learning diaries as in study II become aware of their learning deficiencies (Dembo & Seli, 2004) but do not have any strategies to



overcome these problems. This could result in helplessness with such demotivating effects increasing by the time the diary has to be filled out (Spörer & Brunstein, 2006). Moreover, filling out the learning diary tends to become automatized (Schmitz & Perels, 2011). This is in line with the results of exploratory analyses that showed quadratic effects for the whole intervention period in the learning diary group: After the first days of self-monitoring, some SRL subcomponents increased. This increase reached a plateau after about three weeks and then started to decrease. If students were provided with SRL strategies that could help to overcome their learning deficiencies, the decrease probably could have been avoided. The results of the combination group speak in favor of this hypothesis.

In accordance with this assumption and in accordance with the additive effects hypothesis (Schmitz & Wiese, 2006) the combination of learning diaries and content-independent training was most effective. The multiphase SRL training provided a comprehensive metacognitive framework to value the usefulness of the learning diary and self-monitoring behaviors (Zimmerman, 2008). In turn, the learning diary helped to internalize the newly-learned strategies and to transfer them to everyday learning processes. The result is underpinned by the fact that training effects remained stable in a follow-up test. Nevertheless, the training group showed a further increase from posttest to follow-up test and caught up with the combined group. Such long-term developmental boosts (Hager & Patry, 2000) are often found in training evaluation research. The study therefore suggests that SRL training is sufficient to foster SRL effectively but that this benefit can be boosted and accelerated by the combination of training with learning diaries.

### 6.1.3 Individual Differences in Self-Regulated Learning

Reviewing literature on SRL obviously indicates that there are individual differences concerning this learning competence (e.g., Bidjerano & Dai, 2007; Kitsantas, 2002). Nevertheless, a person-centered approach has seldom been applied in this research field

(Lapka et al., 2011). Therefore, the third study aimed to investigate the presence of SRL profiles and their relation to achievement, personality, and SRL training effectiveness. Using latent profile analyses, four SRL profiles were found: The first profile showed overall low values with a moderate value in motivational subscales (low SRL with moderate motivation), whereas the second profile showed moderate values on all subscales (moderate SRL). The third profile showed a very special pattern: Students of this group had low values on time planning, procrastination (reversed), and self-evaluation in combination with high values on motivational subscales (self-efficacy, intrinsic motivation, goal orientation). As values for the remaining subscales were moderate, this group was named the conflicting SRL with high motivation group. The fourth group showed overall high values and therefore was characterized as the high SRL group. These profiles hint at the importance of motivational components of SRL to classify college students into distinct learner competence groups.

Investigating group differences with regard to achievement gave new insights into the profiles' competence level. The GPA of the university entrance diploma was significantly higher for students in the high SRL group than for students of the low SRL with moderate motivation group and the moderate SRL group. The conflicting SRL with high motivation group was not significantly different from the high SRL group. Therefore, it can be concluded that the high SRL group and the conflicting SRL with moderate motivation group represent more skilled or adaptive SRL profiles, whereas the low SRL with moderate motivation group and the moderate SRL group represent less skilled or rather maladaptive profiles for learning outcomes. This is in line with the assumption that especially motivational components are important for learning success (e.g., Richardson et al., 2012). As the present finding is in accordance with former studies that speak in favor of a positive relation between SRL and achievement (e.g., Liu et al., 2014; Valle et al., 2008), it can be seen as criterion validation for the four profiles found.

Concerning personality differences, study II suggests the assumption that students with more skilled SRL profiles also show well-adjusted personality profiles. Students with adaptive SRL profiles had significantly lower values in test anxiety and neuroticism than students with the maladaptive profiles. This was found in combination with higher values of agreeableness, extraversion, openness and conscientiousness. Differences in conscientiousness were the biggest as all four groups significantly differed from each other on this variable with more skilled SRL profiles showing higher values. These findings are in accordance with previous studies investigating the relation between learning competences and personality: conscientiousness and openness have been revealed as being positively related to motivational and strategic learning competences (Chamorro-Premuzic & Furnham, 2003; Slaats et al., 1997), whereas neuroticism and test anxiety show negative effects on learning processes (Bidjerano & Dai, 2007). Concerning agreeableness and extraversion, study III gives new insights and speaks in favor of a positive impact of these personality traits on learning competences. This is interesting as previous studies did not find a clear direction of relations (e.g., Eilam et al., 2009; Matthews, 1997). As students of the conflicting SRL with high motivation group showed a personality profile that was almost as positive as the high SRL group's personality profile, it is defensible to assume that motivational subcomponents of learning can override the effect of missing SRL competences. It would be desirable to investigate this result pattern in depth, conducting longitudinal studies that give new insights on the causal relations between SRL and personality development.

As the third study adopted a person-centered perspective, how the SRL profiles impact the effectiveness of an SRL intervention was investigated. Although the intervention has been found to be effective in general (see study II), individual differences in treatment effects are possible. It was revealed that only students of the moderate SRL group and the conflicting SRL with high motivation group could increase their SRL values from pre- to posttest. This result pattern was found to be stable for the follow-up test. This is in accordance with

previous findings indicating a compensation effect (Klauer, 1993) in SRL trainings (Gonzalez-Pienda et al., 2014). Interestingly, the low SRL with moderate motivation group could not significantly increase with training. This leads to the assumption that baseline SRL skills have to be present to be developed during training and that instructional support was not as intensive as it has to be to foster this group in an optimal way (Kalyuga, 2007). As the conflicting SRL with high motivation group showed the highest effect size, it seems reasonable that motivational subcomponents play a crucial role in benefitting from training. Because this group possesses high self-efficacy beliefs in combination with intrinsic motivation and an optimal goal orientation, it can be hypothesized that such a motivational constellation is advantageous for training. Students of this group are highly motivated but show deficiencies in SRL strategies that can easily be evolved with the help of training. With regard to the high SRL group, it can be assumed that students with this profile have less potential to develop their competences further. Nevertheless, future research could investigate if this group would benefit from trainings that have a more non-linear conceptualization (Mcmanus, 2000) and that incorporate more independent problem-solving (Fyfe et al., 2012). Nevertheless, the present training had at least no mathemathanic effects on high SRL students (Snow, 1976), which could be the case if interventions are demotivating for special groups of students.

## 6.2 Limitations

The present thesis aimed to model SRL in college students and to investigate how this lifelong-learning competence can be fostered most effectively in this target group by integrating an individual difference perspective. Although the thesis provided new insights into SRL's structure and intervention methods to foster this learning skill, several limitations have to be mentioned when reviewing the thesis. These are described in the following section with a focus on study design and assessment methods.

### 6.2.1 Study Design

**Sample.** A general shortcoming of the thesis refers to the samples used in the three studies. Although the thesis aimed to model SRL for college students in general, the heterogeneity of the sample can be regarded as a limitation because participants studied different subjects and had different levels of study experience. Moreover, the samples were predominantly female as a result of the participants' subjects of study (e.g., psychology, languages, etc.). With regard to study I, the heterogeneity of the sample is not a real limitation as the results of the trait model underline SRL's importance for college students irrespective of their subject of study and experience level. Concerning gender effects, it would be interesting to examine if the model fits for both genders as there are some differences in central variables. Whereas males report higher self-efficacy (Huang, 2013) and a higher use of elaborative learning strategies (Bembenutty, 2007), females show higher academic delay of gratification (Bembenutty, 2007). With regard to study II, the heterogeneity of the sample reduces the comparability of intervention groups as the distribution of subjects of study and experience was not the same within the four intervention groups. It is possible that the effects would have been different if all groups were sampled of f. ex. psychology students. Nevertheless, the results found with this heterogeneous sample are in favor of the training and learning diary's usefulness for all groups of college students and therefore have a high external validity. Concerning study III, it is somewhat problematic that the cluster sample and the training sample differ with regard to study subject and university experience. This lowers the generalizability of differential effects found with the training sample. Nevertheless, SRL profiles could be confirmed in the training sample as well speaking in favor of their transferability to different subgroups of students.

An additional shortcoming of the samples used is the size of the training samples. In study II, participants had to be matched using propensity score matching to obtain comparable baseline values of SRL. Matching resulted in the elimination of several participants and

therefore the group size varied between  $n = 27$  and  $n = 55$ . These sizes constitute the lower border of required cell size for multivariate ANOVA. Moreover, the cell sizes were not equally distributed. Therefore, larger sample sizes for the intervention groups and a more equal distribution could have result in a higher power of analyses (Bortz, 2005). Additionally, the quality of study III lacks from the relatively small sample size of the training group and the cluster groups in training. Therefore, power was reduced and possible effects (e.g., the increase for the low SRL with moderate motivation group) were not found. Thus, future studies should aim to investigate differential effectiveness with larger samples to receive more reliable results. Moreover, a larger sample would allow for investigating the combination of SRL profiles with personality profiles and an examination of how they interact in training.

**Quasi-experimental design.** An additional limitation mainly concerns the design of study II and the realization of the factorial combinations. As a randomized assignment of participants to intervention groups was not possible and preexisting groups were used to realize the interventions groups, sample characteristics such as subject of study or college experience decrease the groups' comparability. Although propensity score matching was used to make the groups comparable with regard to pretest SRL, ruling out possible confounding variables can only be realized through randomized control studies that have more statistical power and are easier to interpret. Nevertheless, sampling about 200 college students and assigning them randomly to a training or a control group seems difficult with regard to students' motivation and time they are willing to invest in an educational study. The use of waiting control-groups would be one possibility to equal the effort of all study subjects.

**No active control group.** A further shortcoming is related to this realization of the intervention groups: The control group received no intervention and therefore was a passive control group. Adding an active control group that takes part in an intervention with no SRL content would be useful to rule out possible Hawthorne effects (Bortz & Döring, 2006). Nevertheless, participants of the training groups were not informed of the study design or of

the existence of other groups. Besides that, the possibility of a Rosenthal effect due to trainer behavior that varies between condition and that supports effects for the combined group is rarely given due to the standardization of training.

**Follow-up test.** Although study II integrated a follow-up test to measure the intervention effects' stability, it would have been more interesting to conduct this follow-up test after college exams and after students received feedback on their achievement. As mastery experiences represent the most important source for the development of self-efficacy (Bandura, 1986), information on how the newly acquired strategies work during the preparation for exams would have resulted in more exact ratings of SRL. In addition, follow-up assessments for control groups would have been interesting as well to rule out possible time lagged effects (in particular for the learning diary only group).

### 6.2.2 Assessment Methods

**Self-report measures.** A general shortcoming of this thesis is the high amount of self-report measures used. Adopting a broad view, it is problematic that almost all data (SRL, GPA, personality) were received through self-report measures as this could lead to a method bias that artificially increases relations among variables. Future studies therefore should adopt an expanded range of measurement methods to overcome this problem. Adopting a narrow view, it is especially problematic that SRL data was received through self-reports as they are problematic because of socially desirable ratings or problems of retention and generalization (Winne & Perry, 2000). Moreover, the unconscious and automatized character of learning strategies complicates their objective assessment (Schmitz et al., 2007). As self-reports of SRL do not reflect actual behavior (Artelt, 2000), changes in this measure can only be interpreted as shifts in students' perception of their SRL behavior and the extent to which they engage in SRL processes. Despite these shortcomings, McCardle and Hadwin (2015) emphasize that self-reports "provide important information for examining and interpreting

SRL even when the reports are inaccurate or skewed” (p. 46) as students use their own perception to set goals, monitor their learning, and adapt their behavior. Nevertheless, combining self-reports with more objective data from thinking aloud protocols, peer ratings, interviews, observations, or trace data will bring up more reliable results (Perry & Rahim, 2011; Veenman, 2011). Although CFA results for the SRL questionnaires in studies I and III speak in favor of the measure’s construct validity, the model fit indices are not optimal, indicating that the questionnaires have to be adopted. Further results concerning the measure’s validity are needed as well.

**Study I: Self-efficacy.** With regard to study I, the CFA for the SRL questionnaire revealed low factor loadings for self-efficacy on the motivational belief factor. Accordingly, Usher and Pajares (2008) emphasize that self-efficacy is not directly a part of motivation but rather a precursor to motivation. Moreover, the self-efficacy items used were adopted from the general self-efficacy scale from Jerusalem and Schwarzer (1981). As the SRL model in study I refers to academic context, it would have been more adequate to use items representing academic self-efficacy. Moreover, the subscale for measuring organizational learning strategies showed a low reliability, which is why future studies should aim to optimize this subscale.

**Study I: GPA.** A further shortcoming of study I is the achievement marker used. As the GPA of the university entrance diploma stems from the past, the measure is rather retrospective and cannot be used to test the predictive power of SRL for achievement. The current GPA of the subject of study, therefore, would have been more adequate as it indicates the concurrent validity of the SRL model. Nevertheless, the GPA of the university entrance diploma was used for three reasons. First, the GPA of the subject of study showed a lot of missing values, which can lead to problems in SEM. Second, students of the sample were quite heterogeneous regarding their subject of study. As grades of different subjects cannot be compared in the German college system (Müller-Benedict & Tsarouha, 2011) the predictive



power of SRL would have been impaired. Third, the GPA of the university entrance diploma represents a very central achievement marker in the German educational system. Its results are highly comparable between students as they have to pass curricular-based national exams in the same class level. Therefore, this indicator is used for university applicant selection processes and shows a high correlation to university achievement (Wedler, Troche, & Rammsayer, 2008). As SRL is modeled as a rather stable trait in study I, assuming relations to retrospective measures is defensible. Nevertheless, future studies should aim to obtain comparable current achievement markers from the university (e.g., by testing the model for one specific group of students) or should make use of objective achievement tests.

**Study II: Learning diaries.** Concerning study II, the use of learning diaries in addition to the SRL questionnaire should diminish the problems of self-report data. As learning diaries are filled out close to the actual learning process, they help to assess learning actions instead of reflections on learning (Artelt, 2000) and are therefore less prone to retention errors (Landmann & Schmidt, 2010). Moreover, they are the method of choice to assess SRL as state and thus should be more sensitive to changes caused by an intervention (Schmitz & Wiese, 2006). Although learning diaries help to assess SRL processes close to their actual occurrence, this method is not free from criticism. On the one hand, learning diaries are self-reports as well and therefore do not represent an objective measure of SRL. On the other hand, the use of learning diaries is accompanied by the confounding of their concurrent functions as assessment method and intervention method. As learning diaries initiate continuous monitoring behavior of students' own learning processes, they should activate reflection and regulation processes (Landmann & Schmidt, 2010; see section 2.3.2). Moreover, they serve as an external structuring aid of learning processes (Nückles, Renkl, & Fries, 2005) and therefore increase the reflection of learning contents and help to uncover learning deficits (Connor-Greene, 2000; Spörer & Brunstein, 2006). Nevertheless, this

problem was tackled by the 2 (training yes/no) x 2 (learning diary yes/no) design that informed on the single intervention effects and the combined intervention effects.

**Study II: SRL language exposure.** With regard to the increase of SRL on questionnaire level in study II, one could argue that this is a result of the constant exposure to “SRL language” in training that primes the selection of items (Spörer & Brunstein, 2006). Nevertheless, this increase is only found for the training group and the training + learning diary group, although the learning diary group was exposed to this language as well, and to a higher extent than the training group. Despite this exposure, participants of that group did not show a significant increase on the questionnaire level and even showed significant decreases concerning learning diary data.

**Study II: Transfer effects.** As no transfer effects of the SRL interventions in study II were found for the working efficiency test, it is defensible to assume that this test does not necessitate SRL strategies. This test requires rather short-term strategies to focus attention, whereas SRL refers to a whole learning cycle with several subgoals. Therefore, future research should aim to develop achievement tests that can be used to measure SRL content-independent and objectively (Veenman, 2011). Using grades of a specific exam as achievement markers could lead to new insights, but this is only realizable with students of the same subject and experience level, and therefore limits the generalizability of results to other groups of students. In general, Hasselhorn and Mähler (2000) recommend using methods that assess the direct effects of the intervention but that differ sufficiently from actual intervention contents.

**Study III: Personality measure.** In addition to the abovementioned shortcomings concerning self-reports, study III could be criticized with regard to the personality measure. Because of the number of variables assessed, a short version of the Big Five Inventory was used (Rammstedt & John, 2005). Nevertheless, this instrument assesses each personality dimension with only four items and showed low reliabilities for some of the subscales

(agreeableness, openness to experience). Future studies therefore should investigate the relation of SRL with personality that is assessed through a more elaborate inventory. Moreover, for study III it would also have been interesting to know if transfer effects differ for the four cluster groups of trained participants. Therefore, an objective and content-independent transfer task to measure the cycle of SRL strategies has to be developed.

### 6.3 Future Research Directions

The present thesis investigated the structure of SRL and tackled the question of how to foster this competence most effectively in college students. Moreover, it examined individual differences in SRL and revealed how these influence the effectiveness of SRL training. The results can be used to initiate new research concerning those issues and to answer remaining and newly-emerged questions.

#### 6.3.1 SRL Trait Model and its Transfer to State Level

Study I investigated a trait model of SRL and showed that the integration of a volitional factor besides motivational, cognitive, and metacognitive factors is possible. Model fit indices speak in favor of integrating volitional aspects besides motivational beliefs to represent a broader motivational learning trait, which is why future studies in the area of SRL should include volitional factors as well (Wolters, 1999). As study I is in favor of composing academic delay of gratification, future time perspective, and reverse procrastination to represent a volitional learning trait, these measures are adequate to measure volitional for learning in future research. Study I represents a first attempt to model SRL as a trait by integrating motivational, volitional, cognitive, and metacognitive factors.

Future studies should aim to extend this model by investigating different aspects: As the model conceptualizes SRL as a stable trait, it would be very informative to investigate the model's stability because the structure should also be found in a delayed measurement.

Moreover, there are gender differences concerning some of the SRL factors (e.g. Zimmerman & Kitsantas, 2014), which is why the trait model should be investigated for both genders separately. Comparing both models' fit to the data can lead to new insight on gender differences in general SRL. Additionally, it would be interesting if the structure holds with data that is gained from other assessment methods: measuring SRL through interviews, peer ratings, or observations and testing the model with those data could emphasize its generalizability. Moreover, testing the model's relationship with achievement markers such as ability tests or college exams would be a necessary condition to assume the model's predictive validity. Additionally, the data for the trait model were collected at one point in time, which is why it is not possible to investigate causal relations or directions between several subcomponents. As causal relations between the components can be assumed because motivational beliefs and volitional actions are part of different learning phases (Kuhl, 1984), longitudinal studies would help to investigate such issues. Moreover, some authors have stated mediation and moderation hypotheses concerning the role of volition for the relation of SRL (especially motivational beliefs) and achievement (e.g., Husman et al., 2000). Therefore, testing mediation models could result in new insights as well. Examining the structure of SRL in younger children and conducting longitudinal developmental studies seems promising.

As described in section 2.2.2, SRL models can be distinguished into trait and state models. Although recent research mainly investigated state models using online measurements (e.g., Bannert, Reimann, & Sonnenberg, 2014) there is evidence that SRL can be conceptualized as a trait that is stable between tasks (Moos & Miller, 2015). Despite this ambiguity and the fact that the conceptualizations differ with regard to the underlying time spans of learning and their scope of application, several authors argue for the integration of trait and state models to illustrate SRL (e.g., Efklides, 2011; Schmidt, 2009). In line with this, findings from Hong (1995, 1998) speak in favor of a high interrelation between trait SRL and

state SRL. With regard to the newly developed trait model of SRL that is described in study I, it would be interesting to know how this model can be transferred to the state level.

Following Zimmerman (2000), it should be possible to model SRL as a cycle that integrates forethought, performance, and reflection phases. As the SRL components of the trait model should be important to all three phases, future research should investigate whether the traits influence state behavior and if they are equally important within each phase (Figure 10). With regard to action-control theory (Garcia et al., 1998), it could be assumed that motivational beliefs are crucial to the forethought phase when goals are set, whereas volitional aspects are more important to the performance phase when actions are implemented. Nevertheless, volitional factors can also positively influence components of the forethought phase such as time planning, as effort resources are needed in this phase as well. Motivational beliefs could influence the processes of the reflection phase as more self-efficacious students are prone to more useful causal attributions. Learning diary data that are aggregated over measurement points could be used in CFA for modeling SRL's structure by conducting separate CFAs for each phase of SRL. Moreover, asynchronous correlations between lagged time-series can be informational with regard to relations between subsequent phases (e.g., post-actional and pre-actional phases; Schmidt, 2009). In addition, dynamic relationships between single state variables could be investigated using multivariate time series analyses and ARIMA models (Perels, Otto, Landmann, Hertel, & Schmitz, 2007).

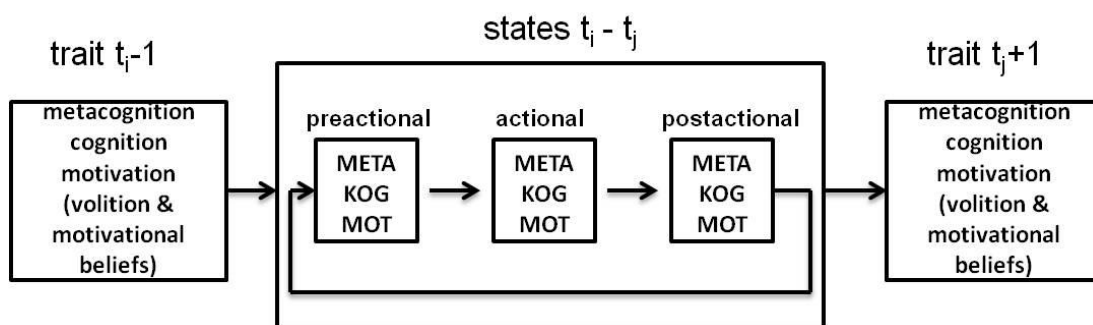
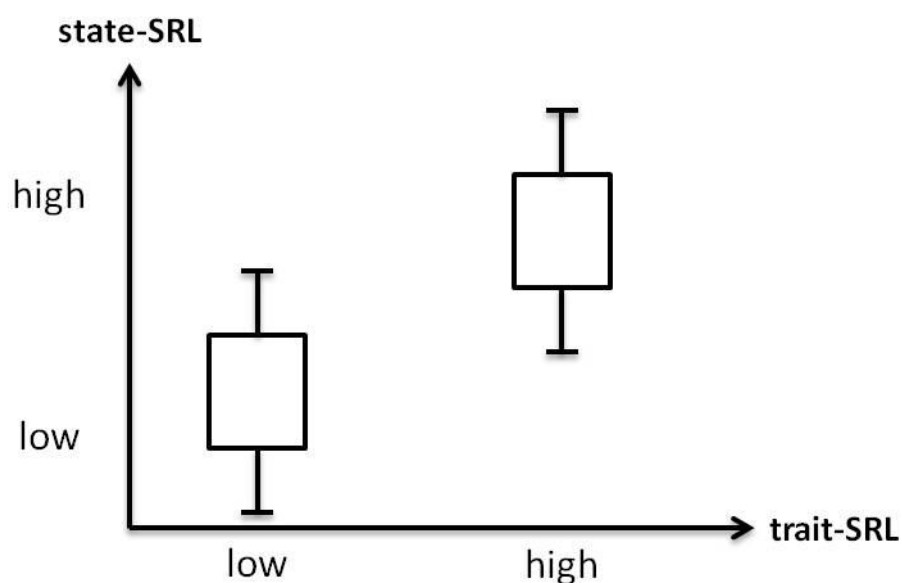

Figure 9. Integrative trait-state model of SRL.

With regard to the relation between trait SRL and state SRL, it could be assumed that trait SRL influences state SRL and determines a frame for state SRL. State SRL of individuals with low trait SRL varies within a range that is beneath the range of individuals with high trait SRL (see Figure 11). Therefore, questionnaire data and learning diary data should show correlations of moderate size.



*Figure 10.* Hypothetical influence of trait SRL on state SRL.

Moreover, it can be assumed that changes in state SRL (e.g., due to SRL training) in turn influence trait SRL. Increases in trait SRL therefore should mainly correspond to increases in state SRL, and the difference between trait SRL before and after the intervention should fit to the increase on state level. Correlations of trait SRL change scores with respective beta-values of linear trends of the learning diary could be one possibility to examine the relation of both levels (Schmidt, 2009). As context factors influence the increase of state SRL (e.g., mood, time pressure; Schmidt, 2009), correlations are hypothesized to be of moderate size. Additionally, aggregated state data of different time points could be used as predictors in a regression model for trait SRL and provide information on explained variance in trait SRL through state SRL. Lastly, trait SRL data of the first measurement point could be correlated

with aggregated state SRL data of the first half of the time period, and trait SRL data of the second measurement point could be correlated with aggregated state data of the second half of the time period.

### 6.3.2 Training Methods for Self-Regulated Learning

Study II investigated how to foster SRL of college students most effectively by comparing a content-independent SRL training, a learning diary, and their combination. It was found that the training positively influenced students' SRL and that additive learning diaries can boost this effect. The use of learning diaries only, however, had no positive influence on students' SRL.

As the training only lasted for seven weeks, it would be interesting to know if a longer training would boost the effects as well. Astleitner (2010) and Hagenauer (2010) argue for the implementation of expanded interventions as effects may not have developed during such short time periods as in study II. In line with this, Hager and Hasselhorn (2000) explain that intervention effects probably will only be obvious adopting a long-term developmental perspective. Motivational components of SRL especially seem to need intensive instructional support to change in desirable directions (Hasselhorn & Gold, 2006). For example, self-efficacy beliefs can only increase if the student masters several learning cycles successfully and becomes aware of the usefulness of SRL strategies and his or her capability to use them in an optimal way (Bandura, 1986; Otto, Perels, & Schmitz, 2008a). In this context, the so-called sleeper effect could be found as interventional changes do not show up until several weeks and learning periods after the intervention (Labuhn, Bögelholz, & Hasselhorn, 2008). As study II included a follow-up test eight weeks after the training ended, there are first hints concerning such a developmental boost (especially for the training group). Nevertheless, it would be very interesting to know how long these effects last because this helps to estimate the intervention's practical effects (Schmidt, 2009). As Bail et al. (2008) have shown, SRL

intervention effects can last up to four semesters. In conclusion, future research could systematically investigate how the extension of intervention time affects changes in learning behavior and if there are developmental boosts of some SRL subcomponents that are not found directly after the intervention ends. As SRL trainings have a high value for practitioners and college administrators, it is nevertheless important to create economic trainings that can be integrated within college learning environments without much effort. One possibility to elongate intervention time without increasing strain for participating students would be to conduct training sessions only every two weeks with practice and reflection intervals in between.

Regarding the utilization of learning diaries in a college context, study II offers several issues for future research as well. As the learning diary alone did not increase students' SRL, it could be argued to alter its conceptualization when used without further intervention. In study II, items within the learning diary parts were randomized to prevent an answering pattern. This makes it difficult for students to be aware of the connections between subscales. Nevertheless, Schmitz et al. (2011) argue that this awareness supports the synergetic effects of SRL subcomponents. Moreover, Dignath-van Ewijk et al. (2015) found positive effects of their learning diary that was enriched with strategy instruction. Therefore, adding instructional tasks to the diary seems promising when it is used as a single intervention method. Students are aware of the utility of SRL strategies and therefore are prone to transfer them to their everyday learning tasks. Nevertheless, to present an economic intervention device for college, learning diaries must be of acceptable length as they have to be filled out several times. As Schmitz and Perels (2011) recommend, future research should investigate which components of the learning diary are especially helpful to foster SRL. A systematic variation of learning diary contents and assessing the respective effects seems informational on this point. Moreover, the frequency and overall duration of filling out the diary has not been systematically investigated although this could have a severe impact on its effects (Schmitz &



Perels, 2011). Studies to date have set these parameters in dependence on the training that was added and did not follow theoretical guidelines.

### 6.3.3 Adaptive Trainings

Study III investigated the presence of SRL profiles in college students and analyzed how they relate to achievement, personality, and the effects of SRL training. In the sample of this study, four SRL profiles were found that differed quantitatively and with regard to motivational subcomponents. Moreover, students with more skilled profiles showed higher academic achievement and well-adjusted personality profiles. With regard to the SRL training, only students with moderate SRL skills as well as students with conflicting SRL skills and high motivation could benefit.

As this study is the first to investigate the relation of SRL profiles to personality, future research should expand this approach to gain further insights on this topic. Conducting longitudinal studies would help to model causal relations between the development of SRL skills and personality aspects. As personality is seen as a stable trait that is already developed in childhood (Soto & John, 2014), it can be assumed that personality conditions the development of SRL skills. Moreover, these studies would be informational with regard to the relationship of achievement and SRL skills, as it is not clear yet how both constructs are causally interrelated. A further point of interest can be derived by the high correlation of SRL with personality traits (e.g., correlation between SRL and conscientiousness:  $r = .69$ ) as this underpins the assumption that SRL can also be conceptualized as a stable trait. Nevertheless, this seems to contradict the conceptualization of SRL as a dynamic and flexible learning style (Matthews et al., 2000). Section 2.2.2 illustrated that it is possible to see SRL as a stable trait or a dynamic state and that the referring time periods differ between both conceptualizations. Moreover, the assessment methods to measure SRL as a trait (e.g., questionnaire) or state (e.g., learning diary) differ as well. As personality traits are also assessed through

questionnaires, the above mentioned high correlation could be due to method bias of self-reports. Therefore, future research should investigate whether correlations of SRL and personality are found as well for state data, e.g., through analyzing learning diary data. In this context, it would be interesting to know whether the above described SRL profiles are found in diary entries, too, i.e., if these individual differences are reflected in state data. Moreover, learning diary data allows for single case studies (Klug et al., 2011). Selecting very high self-regulated individuals and low self-regulated individuals and tracing their development through learning diary data seems promising.

Additionally, future research could try to develop a person x SRL model. Efklides (2011) has proposed her Metacognitive Affective Model of SRL (MASRL), which is a first attempt to describe interactions between personal variables and SRL variables. Her model includes a person level that is responsible for top-down self-regulation and describes interactions of trait-like characteristics (cognitive ability, metacognitive knowledge and skills, self-concept, perceptions of control, attitudes, emotions, motivation). At the task x person level, effects of these higher-level person characteristics decrease and interact with task demands. This level therefore includes task-specific cognitions, metacognition, and affect, and the self-regulation of affect and effort (bottom-up self-regulation). Accordingly, Schmidt (2009) has proposed a model that integrates personal traits, trait SRL, and state SRL, and all three levels can influence each other and interact reciprocally. Following these approaches, it would be desirable to integrate personality factors in such models and examine the hypothesized relationships empirically. With regard to study I that showed the importance of volitional components for SRL, it would be desirable to integrate variables such as future time perspective and academic delay of gratification into such a Person x SRL model.

Moreover, as students of the lowest and the highest skilled SRL profiles could not benefit from the SRL training in study III, future research should examine the conditions under which these special groups can increase their SRL. Interventions that are tailored to the

specific needs of these groups therefore are desirable. Intensive instructional support could lead to better results for low-skilled students (Kalyuga, 2007), whereas more independent trainings meet the preferences of highly-skilled individuals (Mcmanus, 2000). In line with this, Snow (1976) concluded that defensively motivated students (anxious and conforming) are in need of interventions that provide intensive support and external structure. In contrast, constructively motivated students (able to self-direct learning) are likely to benefit more from less directive interventions that foster students' initiative. As students of the low SRL profile group also showed the highest values on test anxiety, research findings concerning this individual difference variable could also be helpful to tailor SRL interventions to anxious students' needs (Naveh-Benjamin, 1991). With regard to highly-skilled students, it would be necessary to avoid the expertise reversal effect (Lohman, 1986). Students who already possess SRL strategies could become demotivated by training as they are not convinced of the strategies' utility (Klauer, 1993), and existing strategies could interfere with newly acquired strategies (Snow & Lohman, 1984).

#### 6.3.4 Assessment Methods

As mentioned above, there is an ongoing debate about whether to conceptualize SRL as a stable trait or as a dynamic state, and this distinction is obvious in the three studies of this thesis as well. Nevertheless, several authors argue for the justification and utility of both viewpoints, and Winne and Perry (2000) describe that "SRL has properties of an aptitude and an event" (p. 534). Moreover, the authors conclude that SRL should show a high stability when contexts of measurement are homogeneous, whereas stability should be low in heterogeneous situations. The conceptualization of SRL determines the assessment methods that have to be used. Whereas aptitudes need a measurement that aggregates or abstracts over multiple SRL events, events have to be assessed online with regard to their occurrence and the contingencies between several occurrences. Winne and Perry (2000) give an overview of

existing measurement methods to assess the one or the other form of SRL: Questionnaires that ask individuals to generalize their behavior across situations are mostly used to assess SRL as an aptitude. Besides, this can be achieved by the use of structured interviews that record typical behavior concerning certain circumstances or by teacher judgments and peer ratings on distinct observable behavior. In contrast, SRL can be assessed as an event by think aloud protocols that record cognitive processes while a task is performed. Other online assessments include error detection tasks that induce metacognitive monitoring, trace methodologies that assess observable indicators of cognition during task execution, and observations of specific learning behavior when performing a task. Moreover, the use of hypermedia offers new opportunities in the field of event measurement as log-file data can be deduced from hypermedia learning environments (Azevedo, Johnson, Chauncey, & Graesser, 2011). Winne and Perry (2000) conclude that the main difference between aptitude and event measures is their grain size. Whereas aptitudes endure over many weeks, assessment methods have to include a large time span and therefore are rather large grained. In contrast, events represent short-term behavior occurrences, which is why assessment methods have to be fine grained.

With regard to these assessment issues, and especially with regard to self-report data, there are several topics that need future research (Winne & Perry, 2000). For example, it is unclear how students sample their behavior to answer self-report measures. It could be possible that they assign value to learning behaviors by evaluating their importance or frequency or through using an algorithm that includes averaging several events or ranking them by an ordinal dominance. In this context, it is necessary to know how students calibrate between the accuracy of their behavior rating and the actual behavior. One helpful method to resolve these problems is case studies to measure SRL as “an entity as it is situated in context” (Butler, 2011, p. 347). Although the predominant conclusion is that self-reports are less valid and reliable than other assessment methods, Berger and Karabenick (2016) recently investigated the psychometric properties of planning, monitoring, and regulation scales by

adopting a questionnaire in combination with cognitive interviews. The authors found that monitoring and regulation items show adequate construct validity evidence, whereas planning items showed less construct validity.

As no measurement method is free of criticism, Winne and Perry (2000) promote triangulation across distinct methods. Several studies used the multi-method approach to gain new insight into SRL and the measurement of intervention-induced changes. Combining the results of questionnaires, learning diaries, interviews, peer ratings, trace data, and observations is promising to gain new insights into various parts of SRL. Such an approach would be informational on conscious as well as unconscious components of SRL and would offer the possibility of investigating SRL in more depth (Kitsantas et al., 2008). McCardle and Hadwin (2015) compared self-report data from an SRL questionnaire with more fine grained self-report data from weekly reflections of students. Based on both data sources, they extracted profiles of self-regulated learners and were able to cross-fertilize the results of questionnaires with the results of weekly reflections and vice versa. The authors concluded that using multiple forms of self-report data provide in depth data on regulation of learning behavior. Moreover, a study by Trevors, Feyzi-Behnagh, Azevedo, and Bouchet (2016) combined eye tracking data, computer log-files, metacognitive judgments, and concurrent as well as retrospective verbal reports of SRL as an event. This methodology helped the authors gain new insight into the relation of epistemological beliefs and SRL.

In line with this, the development of an objective and reliable transfer test would be a milestone to measure the effects of SRL interventions with regard to a more tangible result. As SRL in this thesis was conceptualized as a content-independent learning competence that provides students with strategies to handle a large amount of college tasks, developing a sample problem that is representative of the college context seems promising. Students would have to work on a task (e.g., preparing a presentation; see Dresel et al., 2015) and could be observed and assessed at several times during the task's completion (e.g., in the forethought

phase during planning, in the performance phase during actual work on the task, and in the reflection phase during evaluation of the completed work). After the intervention, students would have to work on the task again with different content. This would offer the probability to assess SRL with regard to the cyclical process approach (Zimmerman, 2008) and to assess a high number of SRL strategies just when they are in use. Objective standards to evaluate the result of the task could be used as further transfer criterion for SRL interventions.

The previous section pointed out that there is a need for future research to resolve problems with measuring SRL (either as aptitude or as event). For the development of new assessment methods, the structural model of Dresel et al. (2015) could be very helpful. They used expert interviews to develop a model that integrates a strategy dimension, a knowledge dimension, and a process dimension of SRL, which is why the model provides a holistic framework. Several parts of the model can be used to deduce direct guidelines for the development of assessment methods.

#### 6.4 Practical Implications

Besides the abovementioned future research directions, the results of the present thesis help to deduct practical implications and to optimize college students' education. The following section will treat several topics that deserve future awareness of practitioners.

As study I speaks in favor of integrating volitional factors into SRL models, educational practitioners, such as school administrators, teachers, or external trainers, should consider these results when developing instructional innovations to foster SRL. Although the support of metacognitive and cognitive strategy use and of adaptive motivational beliefs is very important, the encouragement and instruction of optimal volitional behavior also represents a central factor when fostering SRL. Therefore, teaching strategies that help to reduce procrastination, value future prospects, and delay gratification in order to achieve academic goals is pivotal in the context of SRL and education.

The results of study II are highly relevant for college practitioners as they show that college students' SRL can be fostered, and that this is done most effectively by combining SRL training with standardized learning diaries. As the training was content-independent and showed positive effects with a heterogeneous sample of college students, it can be assumed that it can be used ubiquitously in college. Therefore, administrators should acknowledge this finding by institutionalizing SRL trainings that are similar to the one conducted in study II. In line with this, it would be desirable if such programs would be obligatory for all students, as no individual is totally self-regulated. Moreover, the results show that the supplementary use of standardized learning diaries can increase training effects on students' SRL. Nevertheless, as the training was effective without learning diaries as well, their use seems to be not absolutely necessary. As learning diaries impose high requirements on students' effort and motivation, practitioners can deliberate about whether to integrate them in addition to training programs and could use them only for target groups that are in special need of self-monitoring support.

As study III has shown that individual differences exist in college student's SRL competences and that these differences can impact the effectiveness of instructional support, practitioners who conduct SRL interventions in college have to be aware of this. The development of adaptive trainings that are tailored to the special needs of these groups would be desirable and should be a goal of college education. In line with the results of study III, a focus on motivational aspects of learning could support training effectiveness. Adaptive trainings are also needed with regard to subjects of study and phases of study (Dresel et al., 2015), as goals and tasks vary depending on these factors.

In conclusion, it can be summarized that the present thesis gives new insights into the theoretical structure of SRL and provides suggestions to foster this competence in college

students. It has been shown that it is promising to integrate volitional components into trait models of SRL, and that this model can be used to derive consequences for SRL measurement and interventions. Moreover, results of the thesis lead to the conclusion that SRL can be fostered most effectively in college by combining direct training interventions with standardized learning diaries. Additionally, the results indicate that it is necessary to adapt SRL interventions to specific needs of different learner groups and to provide college students with optimal learning environments.



## 7 References

- Akinsola, M. K., Tella, A., & Tella, A. (2007). Correlates of academic procrastination and mathematics achievement of university undergraduate students. *Eurasia Journal of Mathematics, Science & Technology Education*, 3(4), 363-370.
- Alexander, P. A. (2013). Calibration: What is it and why it matters? An introduction to the special issue on calibrating calibration. *Learning and Instruction*, 24, 1-3. doi:10.1016/j.learninstruc.2012.10.003
- Alexander, J. M., Carr, M., & Schwanenflugel, P. J. (1995). Development of metacognition in gifted children: Directions for future research. *Developmental Review*, 15(1), 1-37. doi:10.1006/drev.1995.1001
- Artelt, C. (2000). Wie prädiktiv sind retrospektive Selbstberichte über den Gebrauch von Lernstrategien für strategisches Lernen? [How predictive are retrospective self-reports on the use of learning strategies for strategic learning?]. *Zeitschrift für Pädagogische Psychologie*, 14(2/3), 72-84. doi:10.1024//1010-0652.14.23.72
- Artino, A. R., & Stephens, J. M. (2009). Beyond grades in online learning: Adaptive profiles of academic self-regulation among naval academy undergraduates. *Journal of Advanced Academics*, 20(4), 568-601. doi:10.1177/1932202X0902000402
- Astleitner, H. (2010). Methodische Rahmenbedingungen zur Entdeckung der Wirksamkeit von pädagogischen Interventionen [A methodical framework for discovering effects of pedagogic interventions]. In T. Hascher & B. Schmitz (Hrsg.), *Pädagogische Interventionsforschung. Theoretische Grundlagen und empirisches Handlungswissen* [Pedagogical intervention research. Theoretical basiscs and empirical knowledge] (S. 48-62). Weinheim: Juventa.
- Azevedo, R., Johnson, A., Chauncey, A., & Graesser, A. (2011). Use of hypermedia to convey and assess self-regulated learning. In B. Zimmerman & D. Schunk (Eds.),

- Handbook of self-regulation of learning and performance* (pp. 102–121). New York: Routledge.
- Bail, F. T., Zhang, S., & Tachiyama, G. T. (2008). Effects of a self-regulated learning course on the academic performance and graduation rate of college students in an academic support program. *Journal of College Reading and Learning*, 39(1), 54-73. doi:10.1080/10790195.2008.10850312
- Bandura, A. (1982). The self and mechanism of agency. In J. M. Suls (Ed.), *Psychological perspectives on the self* (pp. 3-39). Hillsdale, NJ: Lawrence Erlbaum Associates.
- Bandura, A. (1986). *Social foundations of thought and action: A social cognitive theory*. Englewood Cliffs, NJ: Prentice Hall.
- Bandura, A. (1997). *Self-efficacy: The exercise of control*. New York: Freeman.
- Bannert, M., Reimann, P., & Sonnenberg, C. (2014). Process mining techniques for analysing patterns and strategies in students' self-regulated learning. *Metacognition and learning*, 9(2), 161-185. doi:10.1007/s11409-013-9107-6
- Barnard-Brak, L., Lan, W. Y., & Osland Paton, V. (2010). Profiles in self-regulated learning in the online learning environment. *International Review of Research in Open and Distance Learning*, 11(1), 61-79.
- Bauer, D. J., & Curran, P. J. (2004). The integration of continuous and discrete latent variable models: Potential problems and promising opportunities. *Psychological Methods*, 9, 3–29.
- Baumert, J., Klieme, E., Neubrand, M., Prenzel, M., Schiefele, U., Schneider, W., Stanat, P., Tillmann, K.-J. & Weiß, M. (2001). *PISA 2000: Basiskompetenzen von Schülerinnen und Schülern im internationalen Vergleich* [PISA 2000: basic competences of students compared internationally]. Opladen: Leske + Budrich.
- Bellhäuser, H., Lösch, T., Winter, C., & Schmitz, B. (2016). Applying a web-based training to foster self-regulated learning—Effects of an intervention for large numbers of

- participants. *The Internet and Higher Education*, 31, 87-100.  
doi:10.1016/j.iheduc.2016.07.002
- Bembenutty, H. (2007). Self-Regulation of Learning and Academic Delay of Gratification: Gender and Ethnic Differences among College Students. *Journal Of Advanced Academics*, 18(4), 586-616. doi:10.4219/jaa-2007-553
- Bembenutty, H. (2008). Academic delay of gratification and expectancy–value. *Personality and Individual Differences*, 44(1), 193-202. doi:10.1016/j.paid.2007.07.025
- Bembenutty, H. (2011). New directions for self-regulation of learning in postsecondary education. *New Directions for Teaching and Learning*, 2011(126), 117-124. doi:10.1002/tl.450
- Bembenutty, H., & Karabenick, S. A. (2004). Inherent association between academic delay of gratification, future time perspective, and self-regulated learning. *Educational Psychology Review*, 16(1), 35-57. doi:10.1023/B:EDPR.0000012344.34008.5c
- Bembenutty, H., & Karabenick, S. A. (2004). Inherent association between academic delay of gratification, future time perspective, and self-regulated learning. *Educational Psychology Review*, 16(1), 35-57. doi:10.1023/B:EDPR.0000012344.34008.5c
- Bembenutty, H., McKeachie, W. J., Karabenick, S. A., & Lin, Y. G. (1998). *The relationship between test anxiety and self-regulation on students' motivation and learning*. Paper presented at the annual meeting of the American Psychological Society, Washington, DC.
- Bereiter, C. (2002). *Education and Mind in the Knowledge Age*. London: Routledge.
- Berger, J. L., & Karabenick, S. A. (2016). Construct Validity of Self-Reported Metacognitive Learning Strategies. *Educational Assessment*, 21(1), 19-33. doi:10.1080/10627197.2015.1127751
- Bergman, L. R., Magnusson, D., & El Khouri, B. M. (2003). *Studying individual development in an interindividual context: A person-oriented approach*. Mahwah, N.J.: Erlbaum.

- Bidjerano, T., & Dai, D. Y. (2007). The relationship between the Big-Five model of personality and self-regulated learning strategies. *Learning and Individual Differences*, 17(1), 69-81. doi:10.1016/j.lindif.2007.02.001
- Blüthmann, D. P. I. (2012). Individuelle und studienbezogene Einflussfaktoren auf die Zufriedenheit von Bachelorstudierenden [Individual and academic influence factors on the satisfaction of bachelor students]. *Zeitschrift für Erziehungswissenschaft*, 15(2), 273-303. doi:10.1007/s11618-012-0270-3
- Blüthmann, I., Thiel, F., & Wolfgram, C. (2011). Abbruchtendenzen in den Bachelorstudiengängen. Individuelle Schwierigkeiten oder mangelnde Studienbedingungen [Drop-out tendencies in bachelor programs. Individual difficulties or deficient study conditions]. *Die Hochschule*, 1, 110–126.
- Boekaerts, M. (1997). Self-regulated learning: A new concept embraced by researchers, policy makers, educators, teachers, and students. *Learning and Instruction*, 7, 161–186.
- Boekaerts, M. (1999). Self-regulated learning: Where we are today. *International Journal of Educational Research*, 31(6), 445-457. doi:10.1016/S0883-0355(99)00014-2
- Boekaerts, M., & Corno, L. (2005). Self-regulation in the classroom: A perspective on assessment and intervention. *Applied Psychology*, 54(2), 199-231. doi:10.1111/j.1464-0597.2005.00205.x
- Borg, W. R., & Gall, M. D. (1989). *Educational research: An introduction* (5th ed.). New York: Longman.
- Bortz, J. (2005). *Statistik – für Human- und Sozialwissenschaftler* [Statistics – for the human and social sciences]. Berlin: Springer.
- Bortz, J. & Döring, N. (2006). *Forschungsmethoden und Evaluation* [Research methods and evaluation]. Berlin: Springer.

- Bouffard-Bouchard, T., Parent, S., & Larivee, S. (1991). Influence of self-efficacy on self-regulation and performance among junior and senior high-school age students. *International Journal of Behavioral Development, 14*(2), 153-164. doi:10.1177/016502549101400203
- Breuer, K., & Eugster, B. (2006). Effects of training and assessment in vocational education and training (VET): Reflections on the methodology of assessing the development of traits of self-regulation. *Studies in Educational Evaluation, 32*(3), 243-261. doi:10.1016/j.stueduc.2006.08.001
- Britton, B. K., & Tesser, A. (1991). Effects of time-management practices on college grades. *Journal of Educational Psychology, 83*(3), 405-410. doi:10.1037/0022-0663.83.3.405
- Broadbent, J., & Poon, W. L. (2015). Self-regulated learning strategies and academic achievement in online higher education learning environments: A systematic review. *The Internet and Higher Education, 27*, 1-13. doi:10.1016/j.iheduc.2015.04.007
- Bronson, M. B. (2000). *Self-regulation in early childhood. Nature and nurture*. New York: The Guilford Press.
- Brunstein, J. C., & Glaser, C. (2011). Testing a path-analytic mediation model of how self-regulated writing strategies improve fourth graders' composition skills: A randomized controlled trial. *Journal Of Educational Psychology, 103*(4), 922-938. doi:10.1037/a0024622
- Busato, V. V., Prins, F. J., Elshout, J. J., & Hamaker, C. (1999). The relations between learning styles, the Big Five personality traits and achievement motivation in higher education. *Personality and Individual Differences, 26*(1), 129-140. doi:10.1016/S0191-8869(98)00112-3
- Butler, D. L. (2011). Investigating Self-Regulated Learning Using In-Depth Case Studies. In B. J. Zimmerman & D. H. Schunk (Eds.), *Handbook of Self-Regulation of Learning and Performance* (pp. 346-360). New York: Routledge.

- Carver, C. S., & Scheier, M. F. (2000). On the structure of behavioral self-regulation. In M. Boekaerts, P. R. Pintrich, & M. Zeidner (Eds.), *Handbook of self-regulation* (pp. 42-80). San Diego: Academic Press.
- Ceylan, F., Fiehn, J., Paetz, N.-V., Schworm, S., & Harteis, C. (2011). Die Auswirkungen des Bologna-Prozesses - Eine Expertise der Hochschul-didaktik [Consequences of the Bologna-process – An expertise of high school didactics]. In S. Nickel (Ed.), *Der Bologna-Prozess aus Sicht der Hochschulforschung. Analysen und Impulse für die Praxis* [The Bologna-process from a high school research point of view. Analyses and impulses for practitioners] (pp. 106–122). Gütersloh: CHE.
- Chamorro-Premuzic, T., & Furnham, A. (2003). Personality predicts academic performance: Evidence from two longitudinal university samples. *Journal of Research in Personality, 37*(4), 319-338. doi:10.1016/S0092-6566(02)00578-0
- Chaplin, W. F., John, O. P., & Goldberg, L. R. (1988). Conceptions of states and traits: dimensional attributes with ideals as prototypes. *Journal of personality and social psychology, 54*(4), 541-557. doi:10.1037/0022-3514.54.4.541
- Christ, O. & Schlüter, E. (2012). *Strukturgleichungsmodelle mit Mplus – Eine praktische Einführung* [Structural equation modeling with Mplus – a practical introduction]. München: Oldenbourg.
- Cleary, T. J., Platten, P., & Nelson, A. (2008). Effectiveness of the Self-Regulation Empowerment Program with Urban High School Students. *Journal Of Advanced Academics, 20*(1), 70-107.
- Cohen, M. T. (2012). The importance of self-regulation for college student learning. *College Student Journal, 46*(4), 892-902.
- Connor-Greene, P. A. (2000). Making connections: Evaluating the effectiveness of journal writing in enhancing student learning. *Teaching of Psychology, 27*, 44–46.

- Conzelmann, K., & Kersting, M. (2012). *Arbeitseffizienztest (AET)* [Working efficiency test]. Göttingen: Hogrefe.
- Corno, L. (1993). The best-laid plans: modern conceptions of volition and educational research. *Educational Researcher*, 22(2), 14-22. doi:10.3102/0013189X022002014
- Corno, L. (2001). Volitional aspects of self-regulated learning. In B. J. Zimmerman & D. H. Schunk (Eds.), *Self-regulated learning and academic achievement. Theoretical perspectives* (pp. 191-226). Mahwah, NJ: Erlbaum.
- Cribbie, R. A., & Jamieson, J. (2004). Decreases in posttest variance and the measurement of change. *Methods of Psychological Research Online*, 9(1), 37-55.
- Deci, E. L., & Ryan, R. M. (2000). The "what" and "why" of goal pursuits: Human needs and the self-determination of behavior. *Psychological Inquiry*, 11(4), 227-268. doi:10.1207/S15327965PLI1104\_01
- Dembo, M. H., & Seli, H. P. (2004). Students' Resistance to Change in Learning Strategies Courses. *Journal Of Developmental Education*, 27(3), 2-4.
- Dewitte, S., & Lens, W. (2000). Procrastinators lack a broad action perspective. *European Journal of Personality*, 14(2), 121-140. doi:10.1002/(SICI)1099-0984(200003/04)14:2<121::AID-PER368>3.0.CO;2-#
- DiBenedetto, M. K., & Bembenutty, H. (2011). *Within the Pipeline: Self-Regulated Learning and Academic Achievement among College Students in Science Courses*. A paper presented during the American Educational Research Association, New Orleans, Louisiana.
- DiBenedetto, M. K., & Bembenutty, H. (2013). Within the pipeline: Self-regulated learning, self-efficacy, and socialization among college students in science courses. *Learning and Individual Differences*, 23, 218-224. doi:10.1016/j.lindif.2012.09.015
- Dignath, C., Buettner, G., & Langfeldt, H. P. (2008). How can primary school students learn self-regulated learning strategies most effectively?: A meta-analysis on self-regulation

- training programmes. *Educational Research Review*, 3(2), 101-129. doi:10.1016/j.edurev.2008.02.003
- Dignath-van Ewijk, C., Fabriz, S., & Büttner, G. (2015). Fostering self-regulated learning among students by means of an electronic learning diary: A training experiment. *Journal of Cognitive Education and Psychology*, 14(1), 77-97. doi:10.1891/1945-8959.14.1.77
- Dinsmore, D. L., Alexander, P. A., & Loughlin, S. M. (2008). Focusing the conceptual lens on metacognition, self-regulation, and self-regulated learning. *Educational Psychology Review*, 20(4), 391-409. doi:10.1007/s10648-008-9083-6
- Dörrenbächer, L., & Perels, F. (2015). Volition completes the puzzle: Development and evaluation of an integrative trait model of self-regulated learning. *Frontline Learning Research*, 3(4), 14-36. doi:10.14786/flr.v3i4.179
- Dörrenbächer, L., & Perels, F. (2016). More is more? Evaluation of Interventions to Foster Self-Regulated Learning in College. *International Journal of Educational Research*, 78, 50-65. doi:10.1016/j.ijer.2016.05.010
- Dörrenbächer, L. & Perels, F. (in press). Self-regulated learning profiles in college students: Their relation to achievement, personality, and the effectiveness of an intervention to foster self-regulated learning. *Learning and Individual Differences*. <http://dx.doi.org/10.1016/j.lindif.2016.09.015>
- Dresel, M., Schmitz, B., Schober, B., Spiel, C., Ziegler, A., Engelschalk, T., Jöstl, G., Klug, J., Roth, A., Wimmer, B., & Steuer, G. (2015). Competencies for successful self-regulated learning in higher education: structural model and indications drawn from expert interviews. *Studies in Higher Education*, 40(3), 454-470. doi:10.1080/03075079.2015.1004236
- Duckworth, A. L., Gendler, T. S., & Gross, J. J. (2014). Self-control in school-age children. *Educational Psychologist*, 49(3), 199-217. doi:10.1080/00461520.2014.926225



- Duckworth, A. L., & Seligman, M. E. (2006). Self-discipline gives girls the edge: Gender in self-discipline, grades, and achievement test scores. *Journal of Educational Psychology, 98*(1), 198-208. doi:10.1037/0022-0663.98.1.198
- Dunlosky, J., & Rawson, K. A. (2012). Overconfidence produces underachievement: Inaccurate self evaluations undermine students' learning and retention. *Learning and Instruction, 22*(4), 271–280. doi:10.1016/j.learninstruc.2011.08.003
- Dweck, C. S. (1986). Motivational processes affecting learning. *American Psychologist, 41*(10), 1040-1048. doi: 10.1037/0003-066X.41.10.1040
- Efklides, A. (2011). Interactions of metacognition with motivation and affect in self-regulated learning: The MASRL model. *Educational Psychologist, 46*(1), 6-25. doi:10.1080/00461520.2011.538645
- Eilam, B., Zeidner, M., & Aharon, I. (2009). Student conscientiousness, self-regulated learning, and science achievement: An explorative field study. *Psychology in the Schools, 46*(5), 420-432. doi:10.1002/pits.20387
- Ericsson, K. A., & Lehmann, A. C. (1996). Expert and exceptional performance: Evidence of maximal adaptation to task constraints. *Annual Review of Psychology, 47*(1), 273-305. doi:10.1146/annurev.psych.47.1.273
- Council, E. U. (2002). Council resolution of 27 June 2002 on lifelong learning. *Official Journal of the European Communities, 9*.
- Fabriz, S., Dignath, C. & Poarch, G. J. (2007). Förderung von Selbstregulationskompetenz mit standardisierten Lerntagebüchern [Fostering self-regulation competence with standardized learning diaries]. In M. Krämer, S. Preiser & K. Brusdeylins (Hrsg.), *Psychologiedidaktik und Evaluation VI* (S. 95–104) [Psychology didactics and evaluation VI]. Göttingen: V&R Unipress.
- Fabriz, S., Dignath-van Ewijk, C., Poarch, G., & Büttner, G. (2014). Fostering self-monitoring of university students by means of a standardized learning journal—A longitudinal

- study with process analyses. *European Journal of Psychology of Education*, 29(2), 239–255. doi:10.1007/s10212-013-0196-z
- Fadlelmula, F. K., Cakiroglu, E., & Sungur, S. (2015). Developing a structural model on the relationship among motivational beliefs, self-regulated learning strategies, and achievement in mathematics. *International Journal of Science and Mathematics Education*, 13(6), 1355-1375. doi:10.1007/s10763-013-9499-4
- Feuerstein, R. (1980). *Instrumental enrichment: An intervention program for cognitive modifiability*. Baltimore: University Park Press.
- Fitzmaurice, G., Laird, N., & Ware, J. (2004). *Applied Longitudinal Analysis*. Hoboken: John Wiley & Sons.
- Flavell, J. H. (1978). Metacognitive development. In J. M. Scandura & C. J. Brainerd (Eds.), *Structural/process theories of complex human behavior* (pp. 213 - 245). Alphen aan den Rijn, the Netherlands: Sijthoff and Noordhoff.
- Fuchs, L. S., Fuchs, D., Prentice, K., Burch, M., Hamlett, C. L., Owen, R., & Schroeter, K. (2003). Enhancing third-grade student' mathematical problem solving with self-regulated learning strategies. *Journal Of Educational Psychology*, 95(2), 306-315. doi:10.1037/0022-0663.95.2.306
- Fyfe, E. R., Rittle-Johnson, B., & DeCaro, M. S. (2012). The effects of feedback during exploratory mathematics problem solving: Prior knowledge matters. *Journal of Educational Psychology*, 104(4), 1094-1108. doi:10.1037/a0028389
- Garcia, T., McCann, E. J., Turner, J. E., & Roska, L. (1998). Modeling the mediating role of volition in the learning process. *Contemporary Educational Psychology*, 23(4), 392-418. doi:10.1006/ceps.1998.0982
- Garcia, T. & Pintrich, P. R. (1994). Regulating motivation and cognition in the classroom: The role of self-schemas and self-regulatory strategies. In D. H. Schunk & B. J.

- Zimmerman (Eds.), *Self-regulation of learning and performance: Issues and educational applications* (pp. 127-153). Hillsdale, NJ: Erlbaum.
- Geisler-Brenstein, E., Schmeck, R. R., & Hetherington, J. (1996). An individual difference perspective on student diversity. *Higher Education*, 31(1), 73-96. doi:10.1007/BF00129108
- Goetz, T., Nett, U. E., & Hall, N. C. (2013). Self-regulated learning. In N. C. Hall & T. Goetz (Eds.), *Emotion, motivation, and self-regulation: A handbook for teachers* (pp. 123-166). Bingley, UK: Emerald.
- Gollwitzer, P. M. (1996). The volitional benefits of planning. In P. M. Gollwitzer, & J. A. Bargh (Eds.), *The psychology of action* (pp. 287-312). New York: Guilford Press.
- González-Pienda, J. A., Fernández, E., Bernardo, A., Núñez, J. C., & Rosário, P. (2014). Assessment of a self-regulated learning intervention. *The Spanish Journal of Psychology*, 17, e12, 1-9. doi:10.1017/sjp.2014.12
- Hacker, D. J., Bol, L., Horgan, D. D., & Rakow, E. A. (2000). Test prediction and performance in a classroom context. *Journal of Educational Psychology*, 92(1), 160-170. doi:10.1037/0022-0663.92.1.160
- Hadwin, A. F., & Webster, E. A. (2013). Calibration in goal setting: Examining the nature of judgments of confidence. *Learning and Instruction*, 24, 37-47. doi:10.1016/j.learninstruc.2012.10.001
- Hagenauer, G. (2010). Kurzzeitinterventionen versus Langzeitinterventionen [Short-term interventions vs. long-term interventions]. In T. Hascher & B. Schmitz (Hrsg.), *Pädagogische Interventionsforschung. Theoretische Grundlagen und empirisches Handlungswissen* [Pedagogical intervention research. Theoretical basics and empirical knowledge] (S. 243-251). Weinheim: Juventa.
- Hager, W. & Hasselhorn, M. (2000). Psychologische Interventionsmaßnahmen: Was sollen sie bewirken können? [Psychological interventions: What should they affect?] In W.

- Hager, J.-L. Patry & H. Brezing (Eds.), *Evaluation psychologischer Interventionsmaßnahmen. Standards und Kriterien* [Evaluation of psychological intervention programs. Standards and criteria] (pp. 41-85). Bern: Hans Huber.
- Hager, W. & Patry, J. L. (2000). *Evaluation psychologischer Interventionsmaßnahmen. Standards und Kriterien: Ein Handbuch*. [Evaluation of psychological intervention programmes. Standards and criteria: A handbook.] Bern: Hans Huber.
- Hartwig, M. K., Was, C. A., Isaacson, R. M., & Dunlosky, J. (2012). General knowledge monitoring as a predictor of in-class exam performance. *British Journal of Educational Psychology*, 82(3), 456–468. doi:10.1111/j.2044-8279.2011.02038.x
- Hasselhorn, M. & Gold, A. (2006). *Pädagogische Psychologie: Erfolgreiches Lernen und Lehren*. Stuttgart: Kohlhammer.
- Hasselhorn, M. & Mähler, C. (2000). Transfer: Theorien, Technologien und empirische Erfassung [Transfer: Theories, technologies, and empirical assessment]. In W. Hager, J.-L. Patry & H. Brezing (Hrsg.), *Evaluation psychologischer Interventionsmaßnahmen. Standards und Kriterien* [Evaluation of psychological intervention programs. Standards and criteria] (S. 86-101). Bern: Hans Huber.
- Hattie, J., Biggs, J., & Purdie, N. (1996). Effects of learning skills interventions on student learning: A meta-analysis. *Review of Educational Research*, 66(2), 99-136. doi:10.2307/1170605
- Heckhausen, H., & Kuhl, J. (1985). From wishes to action: The dead ends and short cuts on the long way to action. In M. Frese & J. Sabini (Eds.), *Goal-directed behavior: The concept of action in psychology* (pp. 134-160). Hillsdale, NJ: Lawrence Erlbaum Associates.
- Hertzog, C., & Nesselroade, J. R. (2003). Assessing psychological change in adulthood: an overview of methodological issues. *Psychology and Aging*, 18(4), 639-657. doi:10.1037/0882-7974.18.4.639

- Hofer, B. K., & Yu, S. L. (2003). Teaching self-regulated learning through a " Learning to Learn" course. *Teaching of Psychology, 30*(1), 30-33. doi:10.1207/S15328023TOP3001\_05
- Hogan, R., Hogan, J., & Roberts, B. W. (1996). Personality measurement and employment decisions: Questions and answers. *American Psychologist, 51*(5), 469-477. doi:10.1037/0003-066X.51.5.469
- Hong, E. (1995). A structural comparison between state and trait self-regulation models. *Applied Cognitive Psychology, 9*(4), 333-349. doi:10.1002/acp.2350090406
- Hong, E. (1998). Differential stability of state and trait self-regulation in academic performance. *The Journal of Educational Research, 91*(3), 148-159. doi:10.1080/00220679809597536
- Hong, E., & O'Neil Jr, H. F. (2001). Construct validation of a trait self-regulation model. *International Journal of Psychology, 36*(3), 186-194. doi:10.1080/00207590042000146
- Horstmanshof, L., & Zimitat, C. (2007). Future time orientation predicts academic engagement among first- year university students. *British Journal of Educational Psychology, 77*(3), 703-718. doi:10.1348/000709906X160778
- Huang, C. (2013). Gender differences in academic self-efficacy: A meta-analysis. *European Journal Of Psychology Of Education, 28*(1), 1-35. doi:10.1007/s10212-011-0097-y
- Hughes, J. N., Chen, Q., Thoemmes, F., & Kwok, O. M. (2010). An investigation of the relationship between retention in first grade and performance on high stakes tests in third grade. *Educational Evaluation and Policy Analysis, 32*(2), 166-182. doi:10.3102/0162373710367682
- Husman, J., McCann, E., & Crowson, H. M. (2000). Volitional strategies and future time perspective: embracing the complexity of dynamic interactions. *International Journal of Educational Research, 33*(7), 777-799. doi:10.1016/S0883-0355(00)00050-1

- Imhof, M. & Bachmann, G. (2007). Evaluation von Blended Learning Seminaren für Lehramtsstudierende im Fach Pädagogische Psychologie [Evaluation of blended-learning seminars for preservice teachers in pedagogical psychology]. In M. Krämer, S. Preiser & K. Brusdeylins (Hrsg.), *Psychologiedidaktik und Evaluation VI* [Psychology didactics and evaluation VI] (S. 367-376). Göttingen: V & R unipress.
- Jerusalem, M., & Schwarzer, R. (1981). Selbstwirksamkeit [Self-efficacy]. In R. Schwarzer (Ed.), *Skalen zur Befindlichkeit und Persönlichkeit* [Scales on mental state and personality] (p. 15-28). Berlin: Freie Universität Berlin.
- Kalyuga, S. (2007). Expertise reversal effect and its implications for learner-tailored instruction. *Educational Psychology Review*, 19(4), 509-539. doi:10.1007/s10648-007-9054-3
- Kandemir, M., İlhan, T., Özpolat, A. R., & Palanci, M. (2014). Analysis of academic self-efficacy, self-esteem and coping with stress skills predictive power on academic procrastination. *Educational Research and Reviews*, 9(5), 146-152. doi:10.5897/ERR2014.1763
- Kanfer, F. H., Reinecker, H. & Schmelzer, D. (1996). *Selbstmanagement-Therapie: Ein Lehrbuch für die klinische Praxis* [Self-management therapy: A handbook for clinical practice]. Berlin: Springer.
- Kaufman, L., and Rousseeuw, P.J. 1990. *Finding groups in data: An introduction to cluster analysis*. New York: John Wiley and Sons, Inc..
- Kesici, Ş., Baloğlu, M., & Deniz, M. E. (2011). Self-regulated learning strategies in relation with statistics anxiety. *Learning and Individual Differences*, 21(4), 472-477. doi:10.1016/j.lindif.2011.02.006
- Kitsantas, A. (2002). Test preparation and performance: A self-regulatory analysis. *The Journal of Experimental Education*, 70(2), 101-113. doi:10.1080/00220970209599501

- Kitsantas, A., Winsler, A., & Huie, F. (2008). Self-regulation and ability predictors of academic success during college: A predictive validity study. *Journal of Advanced Academics, 20*(1), 42-68.
- Klauer, K. J. (1993). Trainingsforschung: Ansätze, Theorien, Ergebnisse [Training research: Approaches, theories, results.] In K. J. Klauer (Ed.), *Kognitive Training* [Cognitive training] (pp. 15-63). Göttingen: Hogrefe.
- Kline, R. B. (2005). *Principles and practice of structural equation modeling* (2nd ed.). New York: Guilford.
- Klug, J., Ogrin, S., Keller, S., Ihringer, A., & Schmitz, B. (2011). A plea for self-regulated learning as a process: Modelling, measuring and intervening. *Psychological Test and Assessment Modeling, 53*(1), 51–72.
- Knapp, T. R., & Schafer, W. D. (2009). From Gain Score t to ANCOVA F (and vice versa). *Practical Assessment, Research & Evaluation, 14*(6), 1-7.
- Koriat, A., & Bjork, R. A. (2006). Mending metacognitive illusions: A comparison of mnemonic-based and theory-based procedures. *Journal of Experimental Psychology: Learning, Memory, and Cognition, 32*(5), 1133-1145. doi:10.1037/0278-7393.32.5.1133
- Korotitsch, W. J., & Nelson-Gray, R. O. (1999). An overview of self-monitoring research in assessment and treatment. *Psychological Assessment, 11*(4), 415–425. doi:10.1037/1040-3590.11.4.415
- Kuhl, J. (1984). Volitional aspects of achievement motivation and learned helplessness: Toward a comprehensive theory of action control. In B. A. Maher & W. B. Maher (Eds.), *Progress in Experimental Personality Research* (pp. 101-171). Orlando: Academic Press.

- Kuhl, J. (1985). Volitional mediators of cognition-behaviour consistency. Self-regulatory processes and action vs. state orientation. In J. Kuhl & J. Beckmann (Eds.), *Action control: From cognition to behavior* (pp. 101-128). New York: Springer.
- Kuhl, J. (2000). The Volitional Basis of Personality Systems Interaction Theory: Applications in Learning and Treatment Contexts. *International Journal of Educational Research*, 33(7-8), 665-703. doi:10.1016/S0883-0355(00)00045-8
- Kuhl, J., & Fuhrmann, A. (1998). Decomposing self-regulation and self-control: The volitional component inventory. In J. Heckhausen & C. S. Dweck (Eds.), *Motivation and self-regulation across the life span* (pp. 15-49). New York: Cambridge University Press.
- Labuhn, A. S., Bögelholz, S., & Hasselhorn, M. (2008). Selbstregulationsförderung in einer Biologie-Unterrichtseinheit: Langfristige und differenzielle Wirksamkeit [Forstering self-regulated learning in a biology lesson: long-term and differential effect]. *Zeitschrift für Entwicklungspsychologie und Pädagogische Psychologie*, 40(4), 167-178. doi:10.1026/0049-8637.40.4.167
- Lan, W. Y. (1996). The effects of self-monitoring on students' course performance, use of learning strategies, attitude, self-judgement ability, and knowledge representation. *The Journal of Experimental Education*, 64(2), 101-115. doi:10.1080/00220973.1996.9943798
- Lan, W. (2005). Self-monitoring and its relationship with educational level and task importance. *Educational Psychology*, 25(1), 109-127. doi:10.1080/0144341042000294921
- Landmann, M. (2005). *Selbstregulation, Selbstwirksamkeit und berufliche Zielerreichung. Entwicklung, Durchführung und Evaluation eines Trainingsprogramms mit Tagebuch zur Unterstützung des Self-Monitoring* [Self-regulation, self-efficacy, and occupational



- goal achievement. Development and evaluation of a training program with diary to support self-monitoring]. Aachen: Shaker.
- Landmann, M. & Schmidt, M. (2010). Tagebuch [Diary]. In H. Holling & B. Schmitz (Hrsg), *Handbuch Statistik, Methoden und Evaluation* [Handbook for statistics, methods, and evaluation] (S. 165-172). Göttingen: Hogrefe.
- Landmann, M., Pöhl, A., & Schmitz, B. (2005). Ein Selbstregulationstraining zur Steigerung der Zielerreichung bei Frauen in Situationen beruflicher Neuorientierung und Berufsrückkehr [Self-regulation training to improve goal attainment by women seeking new employment or returning to work]. *Zeitschrift für Arbeits- und Organisationspsychologie*, 49(1), 12-26. doi:10.1026/0932-4089.49.1.12
- Landmann, M., Perels, F., Otto, B., & Schmitz, B. (2009). Selbstregulation [Self-regulation]. In E. Wild & J. Möller (Eds.), *Pädagogische Psychologie* [Educational psychology] (pp. 49-70). Heidelberg: Springer.
- Lapka, D., Wagner, P., Schober, B., Grading, P., & Spiel, C. (2011). Benefits of the person-oriented perspective for program evaluation: Analyzing the differential treatment effects of the Vienna e-lecturing program. *Journal of MultiDisciplinary Evaluation*, 7(16), 66-83.
- Leopold, C. & Leutner, D. (2015). Improving students' science text comprehension through metacognitive self-regulation when applying learning strategies. *Metacognition and Learning*, 10, 313–346. DOI 10.1007/s11409-014-9130-2.
- Leutner, D., Barthel, A. & Schreiber, B. (2001). Studierende können lernen, sich selbst zum Lernen zu motivieren: Ein Trainingsexperiment. *Zeitschrift für Pädagogische Psychologie*, 15, 155-167.
- Little, R. J. A., & Rubin, D. B. (2002). *Statistical analysis with missing data*. Hoboken: John Wiley & Sons.

- Liu, W. C., Wang, C. K. J., Kee, Y. H., Koh, C., Lim, B. S. C., & Chua, L. (2014). College students' motivation and learning strategies profiles and academic achievement: A self-determination theory approach. *Educational Psychology, 34*(3), 338-353. doi:10.1080/01443410.2013.785067
- Locke, E. A. (1991). Goal theory vs. control theory: Contrasting approaches to understanding work motivation. *Motivation and Emotion, 15*, 9-28.
- Locke, E. A., & latham, G. P. (1990). *A theory of goal-setting and task performance*. Englewood Cliffs, NJ: Prentice Hall.
- Lohman, D. L. (1986). Predicting mathemathanic effects in the teaching of higher-order thinking skills. *Educational Psychologist, 21*(3), 191-208. doi:10.1207/s15326985ep2103\_3
- Lüftenegger, M., Schober, B., van de Schoot, R., Wagner, P., Finsterwald, M., & Spiel, C. (2012). Lifelong learning as a goal—Do autonomy and self-regulation in school result in well prepared pupils? *Learning and Instruction, 22*(1), 27-36. doi:10.1016/j.learninstruc.2011.06.001
- Manning, B. H., Glasner, S. E., & Smith, E. R. (1996). The self-regulated learning aspect of metacognition: A component of gifted education. *Roeper Review, 18*(3), 217-223.
- Marsh, H. W., Lüdtke, O., Trautwein, U., & Morin, A. J. (2009). Classical latent profile analysis of academic self-concept dimensions: Synergy of person-and variable-centered approaches to theoretical models of self-concept. *Structural Equation Modeling, 16*(2), 191-225. doi:10.1080/10705510902751010
- Masui, C., & De Corte, E. (2005). Learning to reflect and to attribute constructively as basic components of self-regulated learning. *British Journal of Educational Psychology, 75*(3), 351-372. doi:10.1348/000709905X25030

- Masyn, K. E. (2013). Latent Class Analysis and Finite Mixture Modeling. In T. D. Little (Eds.), *The Oxford Handbook of Quantitative Methods Vol. 2* (pp. 551-611). Oxford: Oxford University Press.
- Matthews, G. (1997). Extroversion, emotion, and achievement: A cognitive-adaptive model. In G. Matthews (Ed.), *Cognitive science perspectives on personality and emotion* (pp. 339-442). Amsterdam: Elsevier.
- Matthews, G., Schwan, V. L., Campbell, S. E., Saklofske, D. H., & Mohamed, A. R. (2000). Personality, self-regulation, and adaptation: A cognitive-social framework. In M. Boekaerts, P. R. Pintrich, M. Zeidner, M. Boekaerts, P. R. Pintrich, M. Zeidner (Eds.), *Handbook of self-regulation* (pp. 171-207). San Diego, CA, US: Academic Press.
- Matthews, G., & Zeidner, M. (2004). Traits, states, and trilogy of mind: An adaptive perspective on intellectual functioning. In D. Y. Dai, & R. J. Sternberg (Eds.), *Motivation, emotion, and cognition: Integrative perspectives on intellectual functioning and development* (pp. 143–174). Mahwah, NJ: Lawrence Erlbaum.
- McCardle, L., & Hadwin, A. F. (2015). Using multiple, contextualized data sources to measure learners' perceptions of their self-regulated learning. *Metacognition and Learning, 10*(1), 43-75. doi:10.1007/s11409-014-9132-0
- McManus, T. F. (2000). Individualizing instruction in a web-based hypermedia learning environment: Nonlinearity, advance organizers, and self-regulated learners. *Journal of Interactive Learning Research, 11*(2), 219-251.
- Moos, D. C., & Miller, A. (2015). The Cyclical Nature of Self-Regulated Learning Phases: Stable Between Learning Tasks?. *Journal of Cognitive Education and Psychology, 14*(2), 199-218. doi:10.1891/1945-8959.14.2.199
- Müller-Benedict, V., & Tsarouha, E. (2011). Können Examensnoten verglichen werden? Eine Analyse von Einflüssen des sozialen Kontextes auf Hochschulprüfungen [Are grades in

- exams comparable to each other? The impact of social context on grading in higher education]. *Zeitschrift für Soziologie*, 40(5), 388-409. doi:10.1515/zfsoz-2011-0505
- Muthén, L. K., & Muthén, B. O. (2012). *Mplus: Statistical analysis with latent variables* (version 7) [Computer software]. Los Angeles: Authors.
- Nandagopal, K., & Ericsson, K. A. (2012). An expert performance approach to the study of individual differences in self-regulated learning activities in upper-level college students. *Learning and Individual Differences*, 22(5), 597-609. doi:10.1016/j.lindif.2011.11.018
- Naveh-Benjamin, M. (1991). A comparison of training programs intended for different types of test-anxious students: Further support for an information-processing model. *Journal of Educational Psychology*, 83(1), 134-139. doi:10.1037/0022-0663.83.1.134
- Niemivirta, M. (2002). Individual differences and developmental trends in motivation: Integrating person-centered and variable-centered methods. In P. R. Pintrich & M. L. Maehr (Eds.), *Advances in motivation and achievement* (pp. 241-275). Amsterdam: JAI Press.
- Nückles, M., Renkl, A., & Fries, S. (2005). Wechselseitiges Kommentieren und Bewerten von Lernprotokollen in einem Blended Learning Arrangement [Reciprocal commenting and assessing of learning protocols in a blended learning arrangement]. *Unterrichtswissenschaft*, 33(3), 227-243.
- Núñez, J. C., Cerezo, R., Bernardo, A., Rosário, P., Valle, A., Fernández, E., & Suárez, N. (2011). Implementation of training programs in self-regulated learning strategies in Moodle format: Results of an experience in higher education. *Psicothema*, 23(2), 274–281.
- Ormrod, J. E. (2006). *Educational psychology*. New Jersey: Pearson Education.
- Otto, B., Perels, F., & Schmitz, B. (2008). Förderung mathematischen Problemlösens anhand eines Selbstregulationstrainings: Evaluation von Projekttagen in der 3. und 4.

- Grundschulklasse [Fostering mathematical problem-solving with a self-regulation training: Evaluation of project days in 3. and 4. primary school grades]. *Zeitschrift für Pädagogische Psychologie*, 22(34), 221-232. doi:10.1024/1010-0652.22.34.221
- Paetz, N.-V., Ceylan, F., Fiehn, J., Schworm, S., & Harteis, C. (2011). *Kompetenz in der Hochschuldidaktik [Competence in highschool didactics]*. Wiesbaden: VS Verlag für Sozialwissenschaften.
- Pajares, F. (2008). Motivational role of self-efficacy beliefs in self-regulated learning. In D. H. Schunk & B. J. Zimmerman (Eds.), *Motivation and Self-Regulated Learning. Theory, Research, and Application* (pp. 111-139). New York: Routledge.
- Park, C. L., Edmondson, D., & Lee, J. (2012). Development of self-regulation abilities as predictors of psychological adjustment across the first year of college. *Journal of Adult Development*, 19(1), 40-49. doi:10.1007/s10804-011-9133-z
- Park, S. W., & Sperling, R. A. (2012). Academic procrastinators and their self-regulation. *Psychology*, 3(01), 12-23. doi:10.4236/psych.2012.31003
- Pastor, D. A., Barron, K. E., Miller, B. J., & Davis, S. L. (2007). A latent profile analysis of college students' achievement goal orientation. *Contemporary Educational Psychology*, 32(1), 8-47. doi:10.1016/j.cedpsych.2006.10.003
- Peetsma, T., Schuitema, J., & Van der Veen, I. (2012). A longitudinal study on time perspectives: Relations with academic delay of gratification and learning environment. *Japanese Psychological Research*, 54(3), 241-252. doi:10.1111/j.1468-5884.2012.00526.x
- Perels, F. (2010). Zeitreihenanalyse [Time-series analysis]. In: H. Holling & B. Schmitz (Hrsg.), *Handbuch Statistik, Methoden und Evaluation [Handbook for statistics, methods, and evaluation]* (pp.632-641). Göttingen: Hogrefe.
- Perels, F., Dignath, C., & Schmitz, B. (2009). Is it possible to improve mathematical achievement by means of self-regulation strategies? Evaluation of an intervention in

- regular math classes. *European Journal of Psychology of Education*, 24(1), 17–32.  
doi:10.1007/BF03173472
- Perels, F., Gürtler, T., & Schmitz, B. (2005). Training of self-regulatory and problem-solving competence. *Learning and Instruction*, 15, 123-139.  
doi:10.1016/j.learninstruc.2005.04.010.
- Perels, F., Merget-Kullmann, M., Wende, M., Schmitz, B., & Buchbinder, C. (2009). Improving self-regulated learning of preschool children: Evaluation of training for kindergarten teachers. *British Journal of Educational Psychology*, 79(2), 311-327.  
doi:10.1348/000709908X322875
- Perels, F., Otto, B., Landmann, M., Hertel, S. & Schmitz, B. (2007). Self-regulation from the process perspective. *Journal of Psychology*, 215(3), 194-204.
- Perry, N. E. & Rahim, A. (2011). Studying self-regulated learning in classroom. In B. J. Zimmerman & D. H. Schunk. (Eds.), *Handbook of self-regulation of learning and performance* (pp. 122-136). New York, NY: Routledge.
- Peverly, S. T., Brobst, K. E., Graham, M., & Shaw, R. (2003). College adults are not good at self-regulation: A study on the relationship of self-regulation, note taking, and test taking. *Journal of Educational Psychology*, 95(2), 335-346. doi:10.1037/0022-0663.95.2.335
- Pintrich, P. R., Smith, D. A. F., Garcia, T., & McKeachie, W. J. (1991). *A manual for the use of the Motivated Strategies for Learning Questionnaire (MSLQ)*. Ann Arbor: University of Michigan, National Center for Research to Improve Postsecondary Teaching and Learning.
- Prenzel, M., Baumert, J., Blum, W., Lehmann, R., Leutner, D., Neubrand, M., Pekrun, R., Rolff, H.-G., Rost, J. & Schiefele, U. (Hrsg.). (2004). *PISA 2003. Der Bildungsstand der Jugendlichen in Deutschland – Ergebnisse des zweiten internationalen Vergleichs [The*

*educational background of young people in Germany – Results of the second international comparison*]. Münster: Waxmann.

Pressley, M., & Ghatala, E. S. (1990). Self-regulated learning: Monitoring learning from text. *Educational Psychologist*, 25(1), 19–33. doi:10.1207/s15326985ep2501\_3

Pressley, M. & Woloshyn, V. & Associates (1995). *Cognitive strategy instruction that really improves children's academic performance* (2nd ed.). Cambridge: MA: Brookline Books.

Rammstedt, B., & John, O. P. (2005). Kurzversion des Big Five Inventory (BFI-K): Entwicklung und Validierung eines ökonomischen Inventars zur Erfassung der fünf Faktoren der Persönlichkeit [Short version of the Big Five Inventory (BFI-K): Development and validation of an ecological inventory to record the five factors of personality]. *Diagnostica*, 51, 195-206.

Reeves, T. D., & Stich, A. E. (2011). Tackling suboptimal bachelor's degree completion rates through training in self-regulated learning (SRL). *Innovative Higher Education*, 36(1), 3–17. doi:10.1007/s10755-010-9152-x

Richardson, M., Abraham, C., & Bond, R. (2012). Psychological correlates of university students' academic performance: a systematic review and meta-analysis. *Psychological Bulletin*, 138(2), 353-387. doi:10.1037/a0026838

Schermelleh-Engel, K., Moosbrugger, H., & Müller, H. (2003). Evaluating the fit of structural equation models: Tests of significance and descriptive goodness-of-fit measures. *Methods of psychological research online*, 8(2), 23-74.

Schmidt, M. (2009). *How to manage your PhD thesis. Development of a process model of self-regulation to foster postgraduate students*. Hamburg: Dr. Kovac.

Schmidt, M. & Otto, B. (2010). Direkte und indirekte Interventionen [Direct and indirect interventions]. In T. Hascher & B. Schmitz (Hrsg.), *Handbuch für Pädagogische*

- Interventionsforschung* [Handbook for pedagogical intervention research] (S. 235-242). Weinheim: Juventa.
- Schmitz, B. (1989). *Einführung in die Zeitreihenanalyse: Modelle, Softwarebeschreibung, Anwendungen* [Introduction to time-series analysis: Models, software description, applications]. Bern: Huber.
- Schmitz, B. (2001). Self-Monitoring zur Unterstützung des Transfers einer Schulung in Selbstregulation für Studierende [Self-monitoring to support transfer of an SRL training for college students]. *Zeitschrift für Pädagogische Psychologie*, 15, 181-197. doi:10.1024//1010-0652.15.34.181
- Schmitz, B. (2009). *SPSS 17 – Skript zum Seminar Prozessforschung [SPSS 17 – Script for the seminar of process research]*. Unveröffentlicht, TU Darmstadt, Deutschland.
- Schmitz, B., Klug, J., & Schmidt, M. (2011). Assessing self-regulated learning using diary measures with university students. In B. J. Zimmerman, & D. H. Schunk (Eds.), *Handbook of self-regulation of learning and performance* (pp. 251–265). New York: Routledge.
- Schmitz, B. Landmann, M. & Perels, F. (2007). Das Selbstregulationsprozessmodell und theoretische Implikationen [The self-regulation model and theoretical implications]. In M. Landmann & B. Schmitz (Hrsg.), *Selbstregulation erfolgreich fördern. Praxisnahe Trainingsprogramme für effektives Lernen* [Fostering self-regulation successfully. Practical training programs for effective learning] (S. 312-327). Stuttgart: Kohlhammer.
- Schmitz, B., & Perels, F. (2011). Self-monitoring of self-regulation during math homework behaviour using standardized diaries. *Metacognition and Learning*, 6(3), 255–273. doi:10.1007/s11409-011-9076-6
- Schmitz, B., & Wiese, B. S. (2006). New perspectives for the evaluation of training sessions in self-regulated learning: Time-series analyses of diary data. *Contemporary Educational Psychology*, 31(1), 64-96. doi:10.1016/j.cedpsych.2005.02.002



- Schober, B., Klug, J., Jöstl, G., Spiel, C., Dresel, M., Steuer, G., Schmitz, B., & Ziegler, A. (2015). Gaining substantial new insights into university students' self-regulated learning competencies. *Zeitschrift für Psychologie*, 223(1), 64–65. doi:10.1027/2151-2604/a000201
- Schober, B., Wagner, P., Reimann, R., & Spiel, C. (2008). Vienna E-Lecturing (VEL): Learning how to learn self-regulated in an Internet-based blended learning setting. *International Journal on ELearning*, 7(4), 703-723.
- Schunk, D. H. (1982). Verbal self-regulation as a facilitator of children's achievement and self-efficacy. *Human Learning*, 1, 265-277.
- Schunk, D. H. & Ertmer, P. A. (2000). Self-regulation and academic learning: Self-efficacy enhancing interventions. In M. Boekaerts, P. R. Pintrich & M. Zeidner (Eds.), *Handbook of self-regulation* (pp. 631-649). San Diego: Academic Press.
- Simpson, M. L., Hynd, D. R., Nist, S. L., & Burrell, K. I. (1997). College academic assistance programs and practices. *Educational Psychological Review*, 9(1), 39-87.
- Sirois, F. M. (2014). Out of sight, out of time? A meta-analytic investigation of procrastination and time perspective. *European Journal of Personality*, 28(5), 511-520. doi:10.1002/per.1947
- Sitzmann, T., & Ely, K. (2011). A meta-analysis of self-regulated learning in work-related training and educational attainment: what we know and where we need to go. *Psychological Bulletin*, 137(3), 421-442. doi:10.1037/a0022777
- Slaats, A., Van der Sanden, J., & Lodewijks, J. (1997, March). *Relating personality characteristics and learning style factors to grades in vocational education*. Paper presented at the Annual Meeting of the American Educational Research Association, Chicago.
- Snow, R. E. (1976). Research on aptitude for learning: A progress report. *Review of Research in Education*, 4, 50-105.

- Snow, R. E. (1992). Aptitude theory: Yesterday, today, and tomorrow. *Educational Psychologist*, 27, 5-32. doi:10.1207/s15326985ep2701\_3
- Snow, R. E., Corno, L. & Jackson, D. (1996). Individual differences in affective and conative functions. In D. C. Berliner & R. C. Calfee (Eds.), *Handbook of educational psychology* (pp. 243-310). New York, NY: Macmillan Library Reference.
- Snow, R. E., & Lohman, D. F. (1984). Toward a theory of cognitive aptitude for learning from instruction. *Journal of Educational Psychology*, 76(3), 347-376. doi:10.1037/0022-0663.76.3.347
- Soto, C. J., & John, O. P. (2014). Traits in transition: The structure of parent-reported personality traits from early childhood to early adulthood. *Journal of Personality*, 82(3), 182-199. doi:10.1111/jopy.12044
- Souvignier, E., & Mokhlesgerami, J. (2006). Using self-regulation as a framework for implementing strategy instruction to foster reading comprehension. *Learning and Instruction*, 16(1), 57-71. doi:10.1016/j.learninstruc.2005.12.006
- Spielberger, C. D. (1980). *Test anxiety inventory*. Palo Alto: Mind Garden.
- Spörer, N., & Brunstein, J. C. (2006). Erfassung selbstregulierten Lernens mit Selbstberichtsverfahren: Ein Überblick zum Stand der Forschung [Assessment of self-regulated learning through self-reports: An overview on research state of affairs]. *Zeitschrift für Pädagogische Psychologie*, 20(3), 147-160. doi:10.1024/1010-0652.20.3.147
- Steel, P. (2007). The nature of procrastination: a meta-analytic and theoretical review of quintessential self-regulatory failure. *Psychological Bulletin*, 133(1), 65-94. doi:10.1037/0033-2909.133.1.65
- Stoeger, H. & Ziegler, A. (2011). Self-regulatory training through elementary-school students' homework completion. In B. J. Zimmerman & D. H. Schunk. (Eds.), *Handbook of self-regulation of learning and performance* (pp. 87-101). New York, NY: Routledge.

- Sundre, D. L., & Kitsantas, A. (2004). An exploration of the psychology of the examinee: Can examinee self-regulation and test-taking motivation predict consequential and non-consequential test performance?. *Contemporary Educational Psychology*, 29(1), 6-26. doi:10.1016/S0361-476X(02)00063-2
- Tabachnick, B. G., & Fidell, L. S. (2007). *Using multivariate statistics* (5th ed.). Boston: Pearson.
- Thoemmes, F. (2012). *Propensity score matching in SPSS*. Retrieved from [http://www.human.cornell.edu/hd/qml/upload/Thoemmes\\_2012.pdf](http://www.human.cornell.edu/hd/qml/upload/Thoemmes_2012.pdf)
- Thronsen, I. (2011). Self-regulated learning of basic arithmetic skills: A longitudinal study. *British Journal of Educational Psychology*, 81(4), 558-578. doi:10.1348/2044-8279.002008
- Trevors, G., Feyzi-Behnagh, R., Azevedo, R., & Bouchet, F. (2016). Self-regulated learning processes vary as a function of epistemic beliefs and contexts: Mixed method evidence from eye tracking and concurrent and retrospective reports. *Learning and Instruction*, 42, 31-46. doi:10.1016/j.learninstruc.2015.11.003
- Tynjälä, P., Salminen, R. T., Sutela, T., Nuutinen, A., & Pitkänen, S. (2005). Factors related to study success in engineering education. *European Journal of Engineering Education*, 30(2), 221-231. doi:10.1080/03043790500087225
- Usher, E. L., & Pajares, F. (2008). Self-efficacy for self-regulated learning: A validation study. *Educational and Psychological Measurement*, 68(3), 443-463. doi:10.1177/0013164407308475
- Valle, A., Núñez, J. C., Cabanach, R. G., González-Pienda, J. A., Rodríguez, S., Rosário, P., Cerezo, R., & Muñoz-Cadavid, M. A. (2008). Self-regulated profiles and academic achievement. *Psicothema*, 20(4), 724-731.

- Van Breukelen, G. J. (2006). ANCOVA versus change from baseline had more power in randomized studies and more bias in nonrandomized studies. *Journal of Clinical Epidemiology*, *59*(9), 920-925. doi:10.1016/j.jclinepi.2006.02.007
- Veenman, M. V. (2011). Alternative assessment of strategy use with self-report instruments: A discussion. *Metacognition and Learning*, *6*(2), 205-211. doi:0.1007/s11409-011-9080-x
- Vermunt, J. K., & Magidson, J. (2002). Latent class cluster analysis. *Applied Latent Class Analysis*, *11*, 89-106.
- Viebahn, P. (1990). *Psychologie des studentischen Lernens. Ein Entwurf der Hochschulpsychologie* [Psychology of college student learning: A draft of highschool psychology]. Weinheim: Deutscher Studien Verlag.
- Wagner, J., Becker, M., Lüdtke, O., & Trautwein, U. (2015). The first partnership experience and personality development A propensity score matching study in young adulthood. *Social Psychological and Personality Science*, *6*(4) 455-463. doi:10.1177/1948550614566092
- Wagner, P., Schober, B., Grading, P., Reimann, R., & Spiel, C. (2010). E-Learning unterstützte Förderung von selbstreguliertem Lernen an der Universität [E-learning based fostering of self-regulated learning in university]. *Zeitschrift für Pädagogische Psychologie*, *24*(3-4), 289-303. doi:10.1024/1010-0652/a000022
- Walberg, H.J., & Tsai, S. (1983). Matthew effects in education. *American Educational Research Journal*, *20*, 359-373. doi:10.2307/1162605
- Warr, P., & Downing, J. (2000). Learning strategies, learning anxiety and knowledge acquisition. *British Journal of Psychology*, *91*(3), 311-333.
- Wedler, B., Troche, S., & Rammsayer, T. (2008). Bericht: Studierendenauswahl—Eignungsdiagnostischer Nutzen von Noten aus Schule und Studium [Report: Selection

- of students—Diagnostic benefit of grades in school and study]. *Psychologische Rundschau*, 59(2), 123-125. doi:10.1026/0033-3042.59.2.123
- Weiner, B. (1979). A theory of motivation for some classroom experiences. *Journal of Educational Psychology*, 71(1), 3-25.
- Weinert, F. E. (2001) Vergleichende Leistungsmessung in Schulen – eine umstrittene Selbstverständlichkeit [Comparative performance testing in schools – a controversial matter of course]. In F. E. Weinert (Hrsg.), *Leistungsmessungen in Schulen* [Performance testing in schools] (S. 17-31). Weinheim: Beltz.
- Weinstein, C. E., Husman, J. & Dierking, D. R. (2000). Self-regulation interventions with a focus on learning strategies. In M. Boekaerts, P. R. Pintrich & M. Zeidner (Eds.), *Handbook of self-regulation* (pp. 728-749). San Diego: Academic Press.
- Weinstein, C. E. & Mayer, R. E. (1986). The teaching of learning strategies. In M. C. Wittrock (Ed.), *Handbook of research on teaching* (pp. 316-327). New York: Macmillan.
- Wiener, N. (1948). *Cybernetics or Control and Communication in the animal and the machine*. Cambridge, MA: MIT Press.
- Wild, K., & Schiefele, U. (1994). Lernstrategien im Studium: Ergebnisse zur Faktorenstruktur und Reliabilität eines neuen Fragebogens [Learning strategies in college: Results concerning the factorial structure and reliability of a new questionnaire]. *Zeitschrift für Differentielle und Diagnostische Psychologie*, 15(4), 185-200.
- Winne, P. H., & Perry, N. E. (2000). Measuring self-regulated learning. In M. Boekaerts, P. R. Pintrich & M. Zeidner (Eds.), *Handbook of self-regulation* (pp. 532-568). San Diego: Academic Press.
- Wirth, J., & Leutner, D. (2008). Self-regulated learning as a competence: Implications of theoretical models for assessment methods. *Zeitschrift für Psychologie*, 216(2), 102–110. doi:10.1027/0044-3409.216.2.102

- Wolters, C. A. (1999). The relation between high school students' motivational regulation and their use of learning strategies, effort, and classroom performance. *Learning and Individual Differences, 11*(3), 281-299. doi:10.1016/S1041-6080(99)80004-1
- Wolters, C. A. (2003b). Regulation of motivation: Evaluating an underemphasized aspect of self-regulated learning. *Educational Psychologist, 38*(4), 189-205. doi:10.1207/S15326985EP3804\_1
- Zeidner, M., Boekaerts, M. & Pintrich, P. R. (2000). Self-regulation: Directions and challenges for future research. In M. Boekaerts, P. R. Pintrich & M. Zeidner (Eds.), *Handbook of self-regulation* (pp. 749-768). San Diego, CA: Academic Press.
- Zhu, Y., Au, W., & Yates, G. (2016). University students' self-control and self-regulated learning in a blended course. *The Internet and Higher Education, 30*, 54-62.
- Zimmerman, B. J. (1989). A social cognitive view of self-regulated academic learning. *Journal of educational psychology, 81*(3), 329-339.
- Zimmerman, B. J. (2000). Attaining self-regulation: A social cognitive perspective. In M. Boekaerts, P. R. Pintrich & M. Zeidner (Eds.), *Handbook of self-regulation* (pp. 13-41). San Diego: Academic Press.
- Zimmerman, B. J. (2008). Investigating self-regulation and motivation: Historical background, methodological developments, and future prospects. *American Educational Research Journal, 45*(1), 166–183. doi:10.3102/0002831207312909
- Zimmerman, B. J. (2011). Motivational sources and outcomes of self-regulated learning and performance. In B. J. Zimmerman & D. H. Schunk. (Eds.), *Handbook of self-regulation of learning and performance* (pp. 49-64). New York, NY: Routledge.
- Zimmerman, B. J., & Bandura, A. (1994). Impact of self-regulatory influences on writing course attainment. *American Educational Research Journal, 31*(4), 845-862. doi:10.3102/00028312031004845

- Zimmerman, B. J., Bandura, A., & Martinez-Pons, M. (1992). Self-motivation for academic attainment: The role of self-efficacy beliefs and personal goal setting. *American Educational Research Journal*, 29, 663-676.
- Zimmerman, B. J., & Kitsantas, A. (1997). Developmental phases in self-regulation: Shifting from process goals to outcome goals. *Journal of Educational Psychology*, 89(1), 29-36. doi:10.1037/0022-0663.89.1.29
- Zimmerman, B. J., & Kitsantas, A. (2014). Comparing students' self-discipline and self-regulation measures and their prediction of academic achievement. *Contemporary Educational Psychology*, 39(2), 145-155. doi:10.1016/j.cedpsych.2014.03.004
- Zimmerman, B. J., & Martinez-Pons, M. (1986). Development of a structured interview for assessing student use of self-regulated learning strategies. *American Educational Research Journal*, 23(4), 614-628.
- Zimmerman, B. J., & Martinez-Pons, M. (1988). Construct validation of a strategy model of student self-regulated learning. *Journal of Educational Psychology*, 80(3), 284-290. doi:10.1037/0022-0663.80.3.284
- Zimmerman, B. J. & Martinez-Pons, M. (1992). Perceptions of efficacy and strategy use in the self-regulation of learning. In D. H. Schunk & J. Meece (Eds.), *Student perceptions in the classroom: Causes and consequences* (pp. 185-207). Hillsdale, NJ: Erlbaum.
- Zimmerman, B. J., Moylan, A., Hudesman, J., White, N., & Flugman, B. (2011). Enhancing self-reflection and mathematics achievement of at-risk urban technical college students. *Psychological Test and Assessment Modeling*, 53(1), 108–127.
- Zimmerman, B. J., & Paulsen, A. S. (1995). Self-monitoring during collegiate studying: An invaluable tool for academic self-regulation. *New directions for teaching and learning*, 1995(63), 13–27. doi:10.1002/tl.37219956305
- Zimmerman, B. J. & Schunk, D. H. (Eds.) (2011). *Handbook of self-regulation of learning and performance*. New York, NY: Routledge.

Zohar, A., & David, A. B. (2008). Explicit teaching of meta-strategic knowledge in authentic classroom situations. *Metacognition and Learning*, 3(1), 59-82. doi:10.1007/s11409-007-9019-4



## 8 Appendix

### 8.1 Publication I

Dörrenbächer, L. & Perels, F. (2015). Volition completes the puzzle: Development and evaluation of an integrative trait model of self-regulated learning. *Frontline Learning Research*, 3(4), 14-36. <http://dx.doi.org/10.14786/flr.v3i4.179>

### 8.2 Publication II

Dörrenbächer, L. & Perels, F. (2016). More is more? Evaluation of Interventions to Foster Self-Regulated Learning in College. *International Journal of Educational Research*, 78, 50-65. <http://dx.doi.org/10.1016/j.ijer.2016.05.010>

### 8.3 Publication III

Dörrenbächer, L. & Perels, F. (in press). Self-regulated learning profiles in college students: Their relation to achievement, personality, and the effectiveness of an intervention to foster self-regulated learning. *Learning and Individual Differences*. <http://dx.doi.org/10.1016/j.lindif.2016.09.015>