



Deutsches  
Forschungszentrum  
für Künstliche  
Intelligenz GmbH

**Research  
Report**

RR-97-07

## **Yet Another Paper about Partial Verb Phrase Fronting in German**

**Stefan Müller**

**September, 1997**

**Deutsches Forschungszentrum für Künstliche Intelligenz  
GmbH**

Postfach 20 80  
67608 Kaiserslautern, FRG  
Tel.: + 49 (631) 205-3211  
Fax: + 49 (631) 205-3210

Stuhlsatzenhausweg 3  
66123 Saarbrücken, FRG  
Tel.: + 49 (681) 302-5252  
Fax: + 49 (681) 302-5341



# **Yet Another Paper about Partial Verb Phrase Fronting in German**

**Stefan Müller**

DFKI-RR-97-07

A shorter version of this paper was published in the proceedings of COLING 96.

© Deutsches Forschungszentrum für Künstliche Intelligenz 1997

This work may not be copied or reproduced in whole or part for any commercial purpose. Permission to copy in whole or part without payment of fee is granted for nonprofit educational and research purposes provided that all such whole or partial copies include the following: a notice that such copying is by permission of the Deutsche Forschungszentrum für Künstliche Intelligenz, Kaiserslautern, Federal Republic of Germany; an acknowledgement of the authors and individual contributors to the work; all applicable portions of this copyright notice. Copying, reproducing, or republishing for any other purpose shall require a licence with payment of fee to Deutsches Forschungszentrum für Künstliche Intelligenz.

ISSN 0946-008X

# Yet Another Paper about Partial Verb Phrase Fronting in German

Stefan Müller\*

Stefan.Mueller@dfki.de  
<http://www.dfki.de/~stefan/>

September, 1997

## **Abstract**

In this paper a very simple HPSG analysis for partial verb phrase fronting is described. A minor change in the feature geometry of signs is sufficient to cope with spurious ambiguity problems previous accounts had.

A problem with ill-formed signs that are admitted by all former HPSG accounts for partial verb phrase fronting known so far will be explained and a solution will be suggested that uses the difference between combinatoric relations of signs and their representation in word order domains.

---

\*Thanks to Frank Keller and Andreas Kathol for comments on an earlier version of this paper. Thanks to Uta Waller for proof-reading.

## 1 Introduction

In recent years, several different analyses for partial verb phrase fronting have been proposed (Pollard, 1996; Nerbonne, 1994; Baker, 1994; Hinrichs and Nakazawa, 1994b). The most promising account so far is that of Hinrichs and Nakazawa. This account, however, suffers from some drawbacks that will be discussed in section 5. I will present a rather simple account that uses the standard NONLOC mechanism HPSG (Pollard and Sag, 1994) provides. In section 3.3, I will discuss a problem that arises for all accounts of partial verb phrase fronting: underspecified COMPS lists. This problem will be solved by means of a new daughter (licensing daughter) in a schema for the introduction of nonlocal dependencies.

## 2 The Phenomena

In German, it is possible to front non-maximal verbal projections.<sup>1</sup>

- (1) a. [Besonders Einsteigern empfehlen] möchte ich Quarterdeck Mosaic, dessen gelungene grafische Oberfläche und Benutzerführung auf angenehme Weise über die ersten Hürden hinweghilft, obwohl sich die Funktionalität auch nicht zu verstecken braucht.<sup>2</sup>
- b. [Viel anfangen] konnte er damit nicht.<sup>3</sup>
- c. [Bei der Polizei angezeigt] hatte das Känguruh ein Autofahrer, nachdem es ihm vor die Kühlerhaube gesprungen war und dabei fast angefahren wurde.<sup>4</sup>
- (2) a. [Erzählen] wird er seiner Tochter ein Märchen.  
 tell will he his daughter a fairy tale  
 ‘He will tell his daughter a fairy tale.’
- b. [Erzählen müssen] wird er seiner Tochter ein Märchen.  
 tell must will he his daughter a fairy tale  
 ‘He will have to tell his daughter a fairy tale.’

In a series of papers, Hinrichs and Nakazawa argued for a special rule schema that combines the verbs of a so-called *verbal complex* before the arguments of the involved verbs are combined with the verbal complex. Because the verbal complex is built before any nonverbal argument of a verb gets saturated, it is possible to account for phenomena like *auxiliary flip* (3).

- (3) , daß er seiner Tochter ein Märchen wird [erzählen können].  
 that he his daughter a fairy will tell be-able-to  
 ‘that he will be able to tell his daughter a fairy tale.’

---

<sup>1</sup>The examples (2) and (5) are taken from Hinrichs and Nakazawa (1994b). See also (Johnson, 1986; Nerbonne, 1986).

<sup>2</sup>c’t, 9/95, p. 156

<sup>3</sup>Wochepost, 41/95, p. 34

<sup>4</sup>taz, 01.18./19.97, p. 32

In (3) the verb *wird* is serialized to the left of the verbal complex it governs. This can be explained easily if it is assumed that *erzählen* and *können* are combined before any non-verbal complement gets saturated.<sup>5</sup>

Since the verbal complex is analyzed as a constituent, the fronting of *erzählen müssen* in (2b) can be explained as well. There is no problem with sentences like those in (2) for the standard NONLOC mechanism. *Erzählen müssen* is a constituent in the non-fronted position in (4) and the same holds if the verbal complex is fronted.

(4) Er wird seiner Tochter ein Märchen [erzählen müssen].

There are, however, examples where a partly saturated verbal complex is fronted.

- (5) a. [Seiner Tochter ein Märchen erzählen] wird er.  
 b. [Ein Märchen erzählen] wird er seiner Tochter.  
 c. [Ein Märchen erzählen] wird er seiner Tochter müssen.  
 d. [Seiner Tochter erzählen] wird er das Märchen.

A verb may appear in the *Vorfeld* with some of its arguments leaving other arguments in the *Mittelfeld*.

As (6) shows, it is possible for a PP in the *Mittelfeld* to modify a fronted verbal complex.

- (6) [Den Kanzlerkandidaten ermorden] wollte die Frau mit diesem  
 the chancellor.candidate kill wanted the woman with this  
 Messer.  
 knife  
 'The woman wanted to kill the candidate with this knife.'

Sentences like (7a) are ungrammatical. It is not possible to front parts of the verbal complex that would be located in the middle of the verbal complex in a verb final sentence (7b).

- (7) a. \* Müssen wird er ihr ein Märchen erzählen.  
 must will he her a story tell  
 b. , weil er ihr ein Märchen erzählen müssen wird.

---

<sup>5</sup>Bouma and van Noord (1996) developed a totally flat analysis that combines all verbs and all of their arguments in one step. It might be the case that an account for sentences like (i) can be developed that is compatible to the flat structure hypothesis but the analysis of (i) is straight forward if one assumes that *lieben wollen* and *lieben müssen* are constituents and *hätte* is flipped over the coordination of those constituents.

(i) Ich liebte ihn, und ich fühlte, daß er mich auch geliebt hat oder doch, daß  
 I loved him and I felt that he me too loved has or but that  
 er mich hätte [[lieben wollen] oder [lieben müssen]]. (Hoberg, 1981, p. 36)  
 he me had love want or love must  
 'I loved him and I felt that he loved me too or rather that he wanted to love me or  
 that he should have loved me.'

The fronting of partial adjective phrases is also possible.

- (8) a. Treu will Karl seiner Frau sein.  
 faithful wants Karl his wife be  
 ‘Karl wants to be faithful to his wife.’
- b. Treu sein will Karl seiner Frau.  
 Faithful be wants Karl his wife
- c. Gespannt darf man darauf sein, wieweit die  
 in.suspense can one this.on be to.what.degree the  
 ‘PC-Terminals’ Akzeptanz finden werden.<sup>6</sup>  
 ‘PC-Terminals’ acceptance find will  
 ‘We can remain in suspense what concerns the degree to which PC ter-  
 minals will be accepted.’
- d. Stolz bin ich nicht auf meinen Bart, sondern darauf, ihn zu  
 proud am I not of my beard but this.of him to  
 zeigen.<sup>7</sup>  
 show  
 ‘I’m not proud of my beard itself, but I am proud of showing it.’

Like (7), (9) is ungrammatical.

- (9) \* Sein will Karl seiner Frau treu.  
 be wants Karl his wife faithful

### 3 The Analysis

#### 3.1 Basic Assumptions

##### 3.1.1 Word Order Domains and Binary Branching Structures

In what follows, I assume a version of HPSG that deviates from standard HPSG in that the surface string of a phrasal sign is not determined by a relation that relates the PHON values of a sign to the PHON values of its daughters (Pollard and Sag, 1987, p. 169). Instead I follow Reape’s (1994) approach. Reape assumes word order domains as an additional level of representation. In such a domain, all daughters of a head occur. These domains differ from the daughter list in that the serialization of elements in a domain (signs) correspond to the surface order of the words in the string. LP-constraints apply to elements of the order domain. Another basic assumption of Reape is that constituents may be discontinuous. Instead of having 2 or 3 schemata for combining heads with their complements like Pollard and Sag (1994), I use only one very general head-complement schema.

---

<sup>6</sup>c’t, 4/96, p. 14

<sup>7</sup>taz, 03.08/09.97, p. 20



It admits exactly one complement in the COMP-DTRS list, which leads to binary branching structures.<sup>8</sup>

### Schema 1 (Head-Complement Schema)

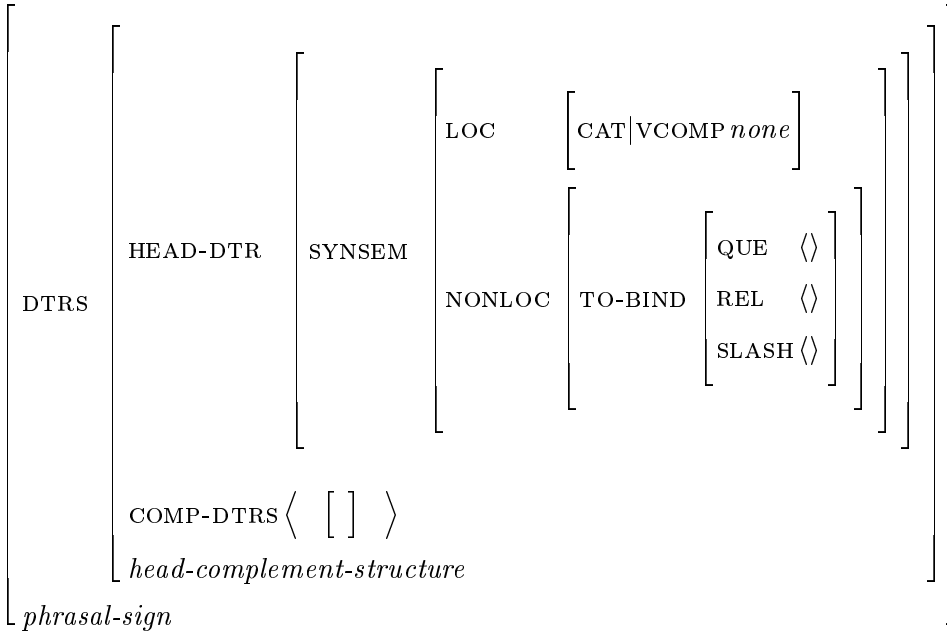

To allow for scrambling, complements are inserted into the domain of their heads by the following implication:

Domain Formation:

$$\left[ \begin{array}{l} \text{DTRS} \\ \textit{head-complement-structure} \\ \textit{phrasal-sign} \end{array} \right] \Rightarrow \left[ \begin{array}{l} \text{DTRS} \\ \text{HEAD-DTR|DOM } \boxed{1} \\ \text{COMP-DTRS} \\ \text{DOM } \boxed{1} \circ \boxed{2} \end{array} \right] \quad (10)$$

A head already contains an appropriate description of its syntactic and semantic properties in its domain.

The  $\circ$  is the *shuffle* relation as used by Reape (1994). The *shuffle* relation holds between three lists A, B, and C, iff C contains all elements of A and B and the order of the elements of A and the order of elements of B is preserved in C. So, if a and b are elements of A and a precedes b in A, it has to precede b in C as well. The PHON value of a phrasal sign is the concatenation of the PHON values of its

<sup>8</sup>I use lists instead of sets for representing nonlocal information. This is due to problems that arise from the understanding of sets in HPSG. See (Müller, 1997a) and (Müller, 1997b) for details.

domain elements.

$$\left[ phrasal-sign \right] \Rightarrow \left[ \begin{array}{c} PHON_{[1]} \oplus \dots \oplus PHON_{[n]} \\ \text{DOM} \left\langle \left[ \begin{array}{c} PHON_{[1]} \\ sign \end{array} \right], \dots, \left[ \begin{array}{c} PHON_{[n]} \\ sign \end{array} \right] \right\rangle \end{array} \right] \quad (11)$$

In (11),  $\oplus$  corresponds to the *append* relation.

The positioning of one constituent in the *Vorfeld* is accounted for by schema 2.<sup>9</sup>

### Schema 2 (Head-Filler Schema)

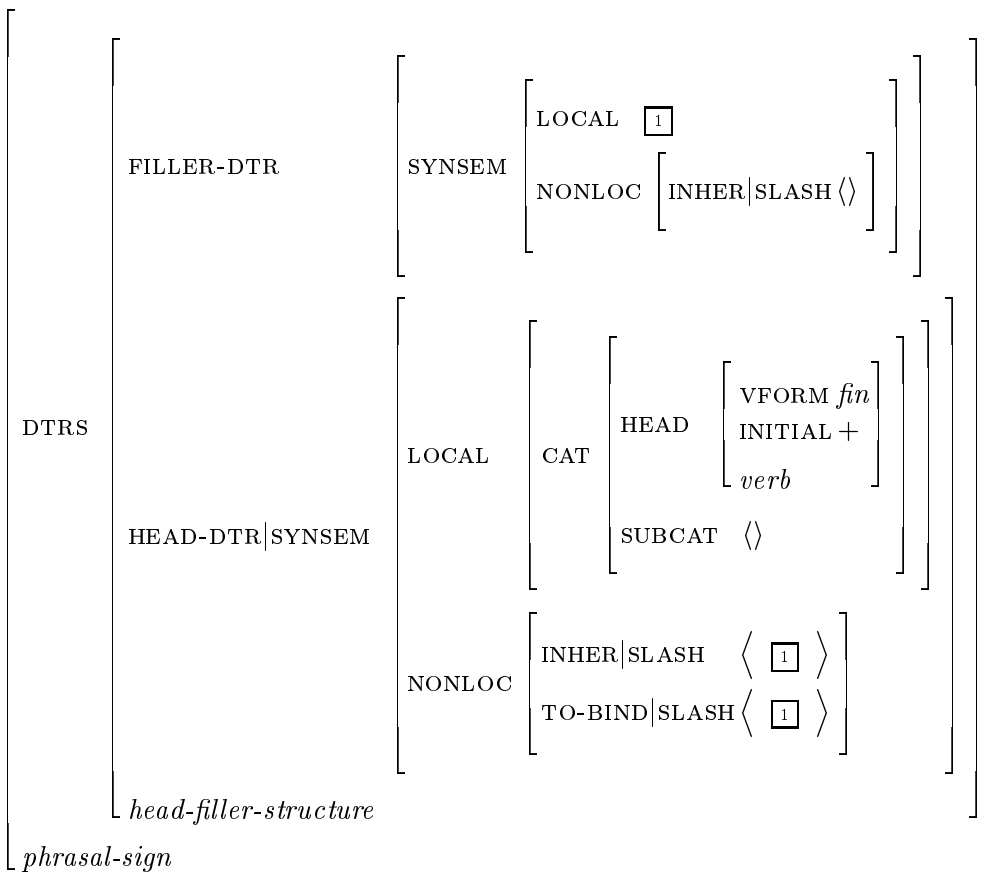

<sup>9</sup>INITIAL is a binary feature that has the value + for heads that are serialized head-initial and the value – for head-final serialization. As I do not assume that there are basic and derived positions for verbs, I do not use the feature INVERTED (INV) for this purpose.

In (Müller, 1997c; Müller, 1997b), I use a generalized version of this schema that can explain other instances of leftward movement as well.

Like complements, fillers are inserted into the domain of their heads.

$$\left[ \begin{array}{c} \text{DTRS} \\ \text{phrasal-sign} \end{array} \left[ \begin{array}{c} \text{head-filler-structure} \end{array} \right] \right] \Rightarrow \left[ \begin{array}{c} \text{DTRS} \\ \text{DOM } \boxed{1} \circ \langle \boxed{2} \rangle \end{array} \left[ \begin{array}{c} \text{HEAD-DTR} | \text{DOM } \boxed{1} \\ \text{FILLER-DTR} \quad \boxed{2} \end{array} \right] \right] \quad (12)$$

It is thus possible to account for linearization phenomena in sentences with multiple extraposed constituents.<sup>10</sup>

The following LP-constraint states that a filler has to be serialized to the left of the verb in initial position.

$$\text{Filler} < V[\text{INI+}] \quad (13)$$

Due to other LP-constraints, complements and adjuncts are serialized to the right of INI+ verbs, and non-extraposed complements and adjuncts are serialized to the left of INI- verbs, i.e. in the *Mittelfeld*.

Schema 3 licenses head-adjunct structures.

### Schema 3 (Head-Adjunct Schema)

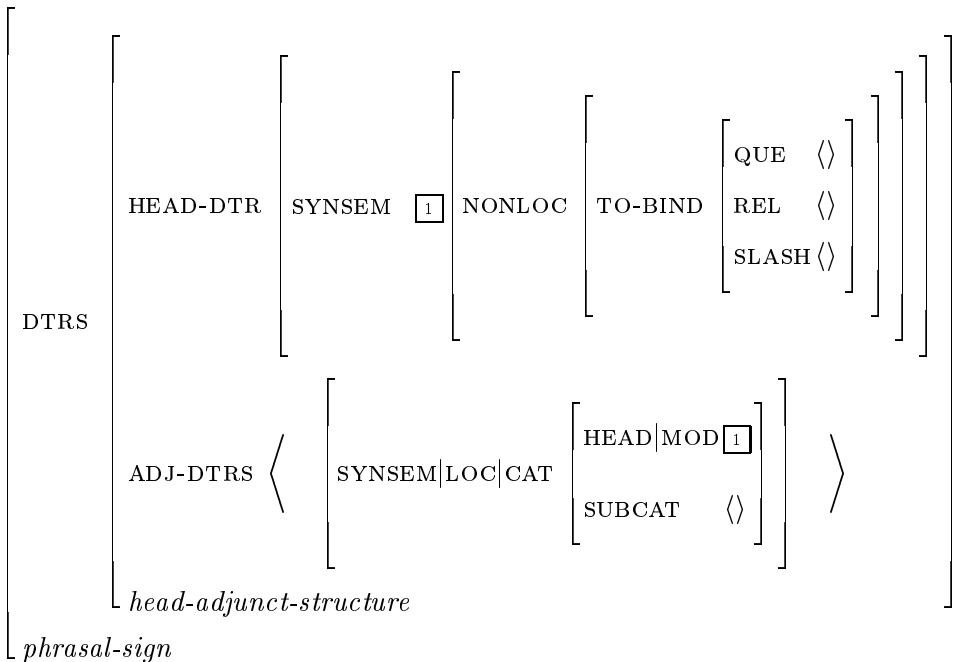

Again, the adjunct daughter is inserted into the domain of the head. Hence the free appearance of adverbs in the *Mittelfeld* is explainable.

Figure 1 shows the syntax tree for the sentence (14).

- (14) Gab der Frau der Mann gestern das Buch?  
 Gave the woman the man yesterday the book  
 ‘Did the man give the book to the woman yesterday?’

<sup>10</sup>For details on extraposition and word order domains see (Kathol and Pollard, 1995) and (Müller, 1997b).

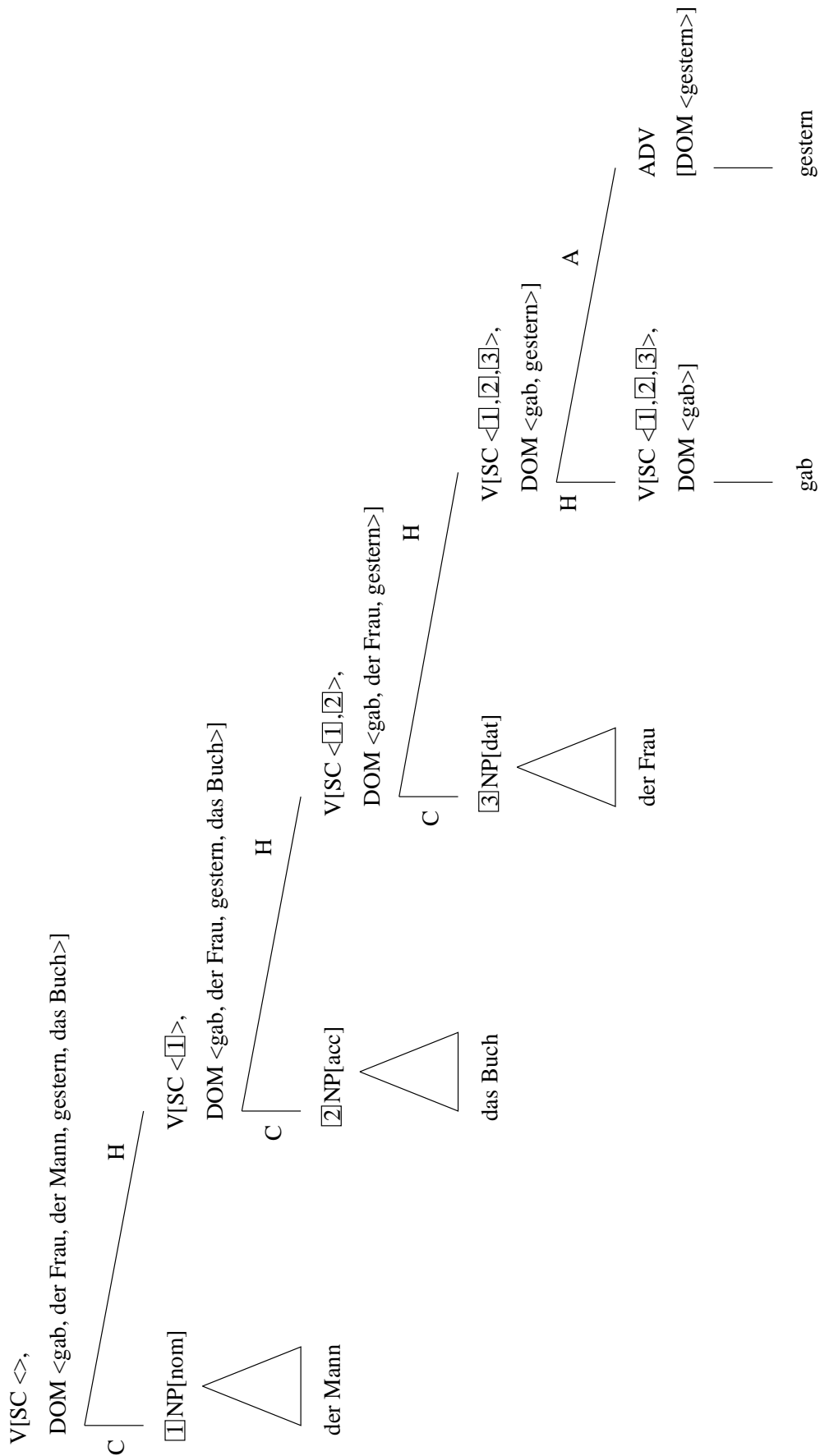

Figure 1: Analysis for *Gab der Frau der Mann gestern das Buch?*

### 3.1.2 The Verbal Complex

As Hinrichs and Nakazawa (1994a) have shown, it is reasonable to assume a schema that licenses the verbal complex in addition to the head complement schema. Hinrichs and Nakazawa introduced the concept of argument attraction into the HPSG framework. When a verbal complex is built, two verbs are combined, and the resulting sign inherits all arguments from both verbs. In their paper, Hinrichs and Nakazawa treat verbal complements as ordinary complements that are included in the COMPS list of their heads. It has, however, proven useful to distinguish the verbal complement from other complements (Rentier, 1994a; Kathol, 1995; Müller, 1997a). The merits of this move will be discussed shortly. For the purpose of representing the information on verbal complements, the feature VCOMP is introduced. Its value is a *synsem*-object if the verb embeds another verb, and *none* otherwise. The entry in the stem lexicon for the future tense auxiliary *werden* (*will*) is illustrated in (15).

*werden*:

$$\left[ \begin{array}{l} \text{HEAD} \quad \left[ \begin{array}{l} \text{SUBJ} \boxed{1} \\ \text{verb} \end{array} \right] \\ \\ \text{COMPS} \boxed{2} \\ \\ \text{VCOMP } V[\text{LEX+}, bse, \text{SUBJ} \boxed{1}, \text{COMPS} \boxed{2}, \text{VCOMP } none] \\ \text{cat} \end{array} \right] \quad (15)$$

From this stem the morphology component produces the finite form shown in (16). In German, almost any complement of a verb can be fronted, subjects as well as objects. Therefore, for finite forms the subject is included into the COMPS list, from where extraction is possible. For nonfinite forms the subject does not appear on COMPS but stays in the SUBJ list.<sup>11</sup>

*wird*:

$$\left[ \begin{array}{l} \text{HEAD} \quad \left[ \begin{array}{l} \text{VFORM } fin \\ \text{SUBJ} \langle \rangle \\ \text{verb} \end{array} \right] \\ \\ \text{COMPS} \boxed{1} \oplus \boxed{2} \\ \\ \text{VCOMP } V[\text{LEX+}, bse, \text{SUBJ} \boxed{1}, \text{COMPS} \boxed{2}, \text{VCOMP } none] \\ \text{cat} \end{array} \right] \quad (16)$$

<sup>11</sup>See (Kiss, 1993) for details.

The following schema licenses verb cluster structures.<sup>12</sup>

#### Schema 4 (Verb Cluster Schema)

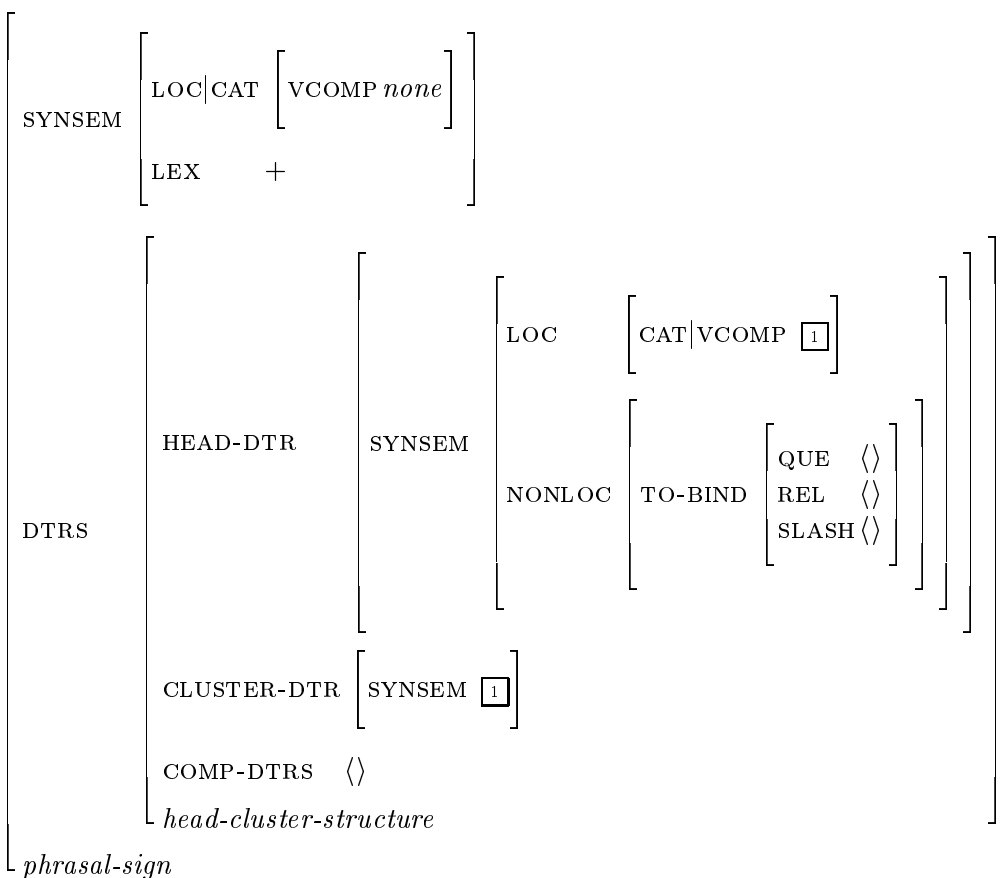

A head is combined with its verbal complement ( $\boxed{1}$ ). The resulting sign is a verbal complex or a part of a verbal complex. It is marked LEX+ because no nonverbal complements have been saturated so far. The resulting verbal complex can, in turn, be embedded.

- (17) , weil er ihm ein Märchen [[erzählen lassen] hat].  
 because he him a fairy tale tell let has  
 ‘because he had somebody tell him a fairy tale.’

$$\left[ \begin{array}{l} \text{DTRS} \left[ \textit{head-cluster-structure} \right] \\ \textit{phrasal-sign} \end{array} \right] \Rightarrow \left[ \begin{array}{l} \text{DTRS} \left[ \begin{array}{l} \text{HEAD-DTR|DOM} \boxed{1} \\ \text{CLUSTER-DTR} \boxed{2} \end{array} \right] \\ \text{DOM} \boxed{1} \circ \langle \boxed{2} \rangle \end{array} \right] \quad (18)$$

<sup>12</sup>Domain formation in verb cluster structures will not be considered in depth. For details see (Müller, 1997b).

### 3.2 The LEX Feature

The LEX feature in the entry for *werden* ensures that a matrix verb is combined with its verbal complement before the verbal complement is saturated by one of its complements. It is therefore possible to avoid multiple structures in the *Mittelfeld*.<sup>13</sup>

- (19) a. Er wird seiner Tochter ein Märchen [erzählen müssen].  
 b. Er wird seiner Tochter [[ein Märchen erzählen] müssen]].  
 c. Er wird [[seiner Tochter ein Märchen erzählen] müssen]].

But precisely those constituents that have to be avoided in the *Mittelfeld* are needed in the *Vorfeld*. This is problematic for all theories which assume that all phrases that appear in the *Vorfeld* can also appear in the *Mittelfeld*. The examples in (20-22) show that this is not the case.<sup>14</sup>

- (20) a. Man wird ja wohl noch fragen dürfen, ob einer links  
 one will yes well still ask may whether somebody left  
 oder rechts wählt.  
 or right votes  
 ‘It should be allowed to ask somebody whether he votes for left or for right-wing parties.’  
 b. [Fragen, ob einer links oder rechts wählt,] wird man ja wohl noch dürfen.  
 c. \* Man wird ja wohl noch [fragen, ob einer links oder rechts wählt,] dürfen.
- (21) a. [Hunde füttern, die Hunger haben,] würde wohl jeder.  
 dogs feed that hunger have would well everyone  
 ‘Presumably everyone would feed dogs that are hungry.’  
 b. \* , daß wohl jeder [Hunde füttern, die Hunger haben,] würde.  
 c. , daß wohl jeder [Hunde, die Hunger haben,] füttern würde.  
 d. , daß wohl jeder Hunde füttern würde, die Hunger haben.
- (22) a. [Giftige Schlangen] gibt es hier keine.  
 poisonous snakes gives it here none  
 ‘No poisonous snakes are to be found here.’

---

<sup>13</sup>Note that this is the only purpose LEX has in my grammar. LEX has the value + if a head was combined with a complement and – otherwise. So if an unsaturated verb is combined with an adjunct its LEX value is still +. This is not the way LEX is seen in the standard framework, and therefore it might be reasonable to choose a different feature name. However, I decided to stick with the name LEX for historical reasons.

<sup>14</sup>(20) is taken from (Reis, 1980, p. 83), (21) from (Haider, 1990, p. 95) and (22) is taken from (Kiss, 1994, p. 98).

- b. \* Hier gibt es keine [giftige Schlangen].
- c. Hier gibt es keine [giftigen Schlangen].  
 here gives it no poisonous snakes
- d. \* [Giftigen Schlangen] gibt es hier keine.

Very complicated mechanisms have been introduced to cope with the problem of unwanted structures in the *Mittelfeld* (Nerbonne, 1994; Hinrichs and Nakazawa, 1994b). I will suggest a very simple solution to the problem: If it is the case that an embedded verb or verbal complex has to be LEX+ when verb and complement are combined locally, and if it is the case that this does not hold if a nonlocal dependency is involved, then the simplest solution is not to view LEX as a local feature. If one assumes that LEX lives under the path SYNSEM, instead of SYNSEM|LOC, then the problem turns into a non-issue.<sup>15</sup>

Figures 2 and 3 show the analyses of the sentences in (23). In the analysis of (23a), a trace functions as a verbal complement. In (23b) a trace for a verb is modified by an adverb.

- (23) a. Seiner Tochter erzählen wird er das Märchen.  
 b. Vortragen wird er es morgen.  
 recite will he it tomorrow  
 ‘He will recite it tomorrow.’

Sentences like (7a), repeated as (24), are ruled out because *wird* selects a complement in *bse*-form that has the VCOMP value *none*, i.e. a complete verbal complex.

- (24) \* Müssen wird er ihr ein Märchen erzählen.  
 must will he her a story tell

As *erzählen* does not appear in any COMPS list, it is not possible for the verb to count as an argument of the fronted verbal complex that is saturated in the *Mittelfeld*. This is the case in Pollard’s account. Hinrichs and Nakazawa have to block this case by stating type constraints on lists of attracted arguments. With a separate VCOMP feature this problem disappears.

The following sentences by Uszkoreit (1987, p. 107) can also be explained if one assumes that idioms are analyzed as complex predicates.

- (25) a. Die Leviten werden wir dem Burschen lesen.  
 the Levites will we the scoundrel read  
 ‘We shall teach this scoundrel a lesson.’
- b. Den Garaus werden wir dem Gesindel machen.  
 the out will we the hoodlums make  
 ‘We’ll kill those hoodlums.’
- c. Eine Abfuhr werden wir dem Aufwiegler erteilen.  
 a removal will we the instigator give  
 ‘We’ll tell the rabble-rouser to shove off.’

---

<sup>15</sup>Detmar Meurers found the same solution independently.



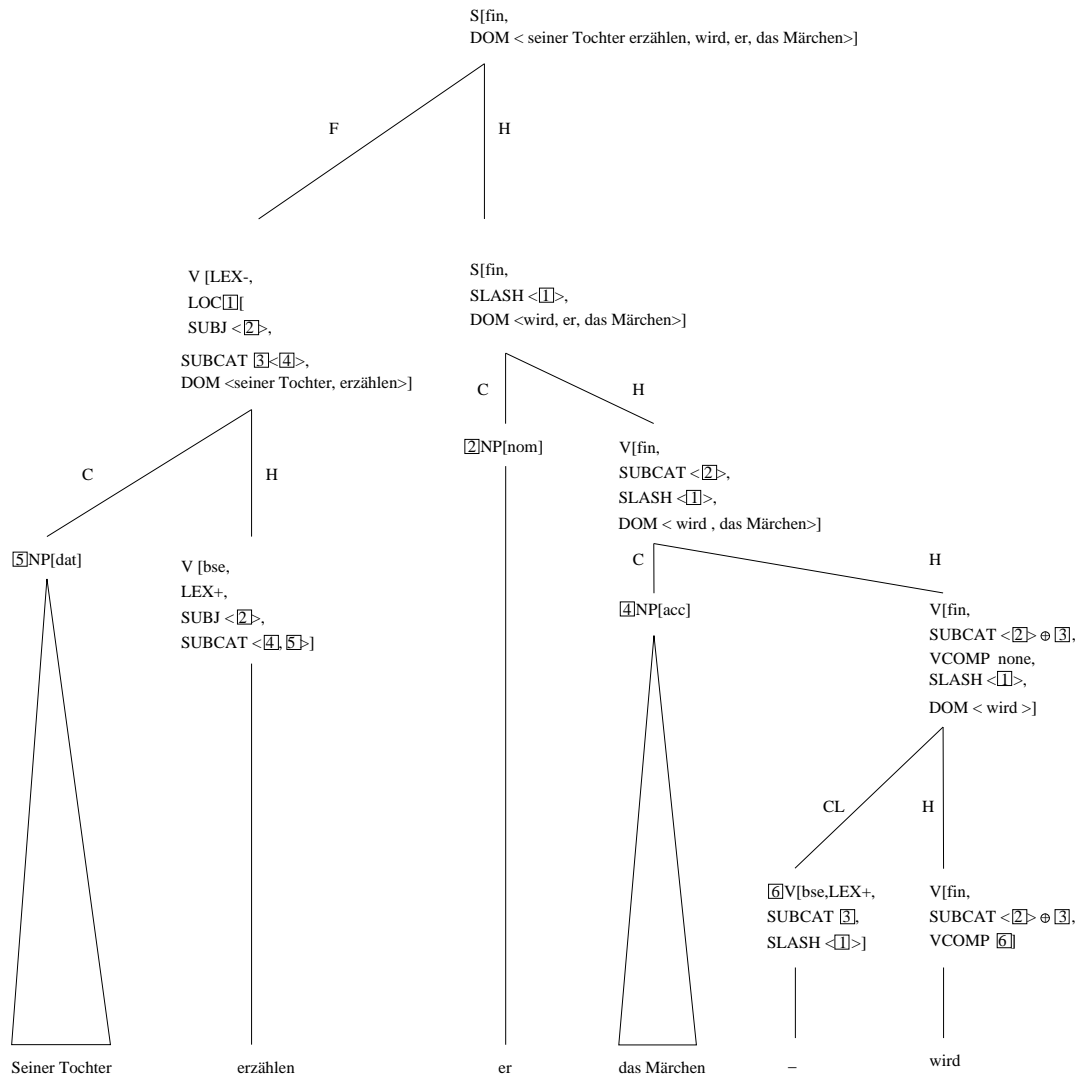

Figure 2: Analysis of *Seiner Tochter erzählen wird er das Märchen*.

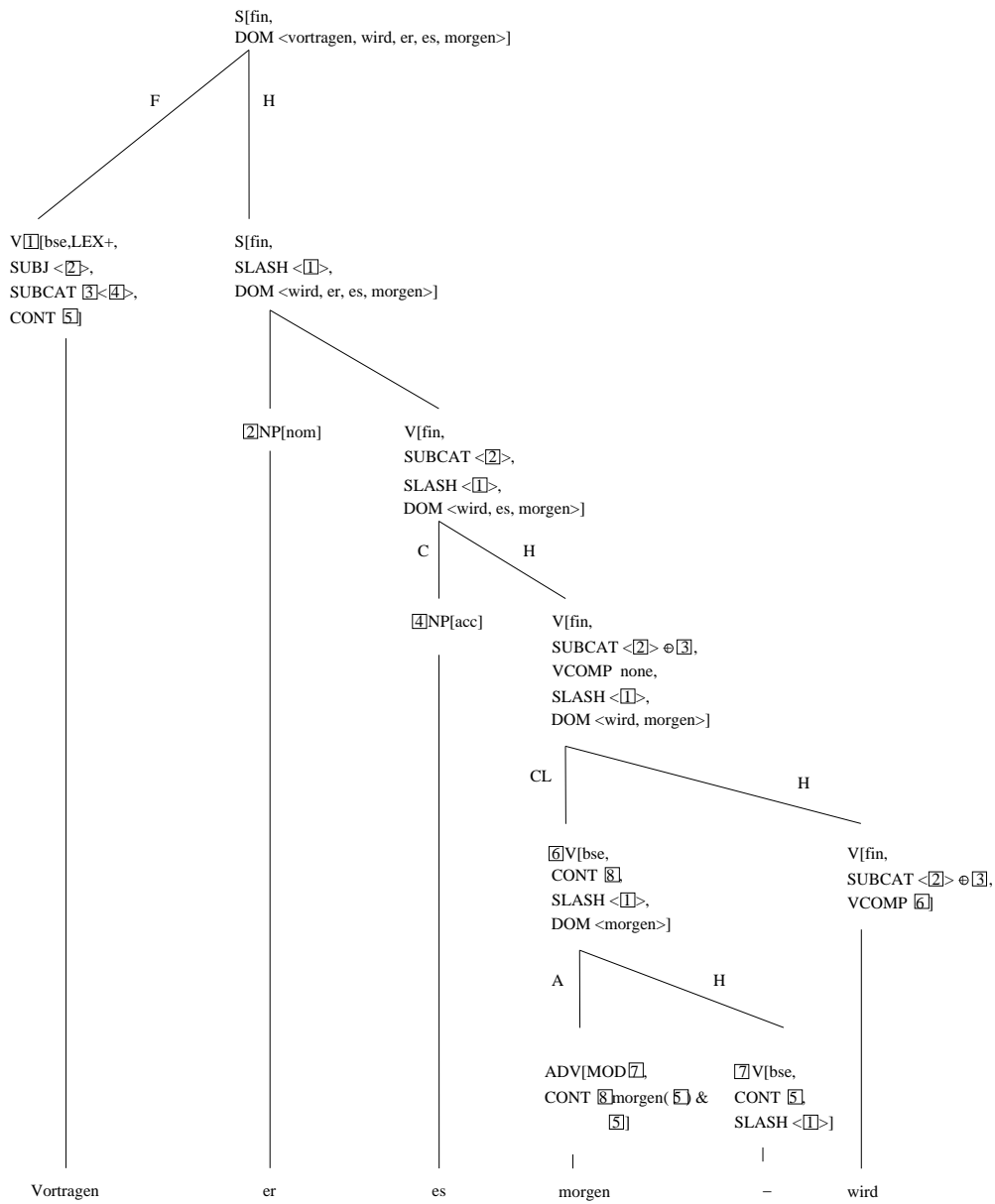

Figure 3: Analysis of *Vortragen wird er es morgen*.

- d. In die Quere waren wir den Polizisten gekommen.  
 in the way were we the police men come  
 ‘We had gotten into the policemen’s way.’
- (26) a. \* Lesen werden wir dem Burschen die Leviten.  
 read will we the scoundrel the Levites
- b. \* Machen werden wir dem Gesindel den Garaus.  
 make will we the hoodlums the out
- c. \* Erteilen werden wir dem Aufwiegler eine Abfuhr.  
 give will we the instigator a removal
- d. \* Gekommen waren wir den Polizisten in die Quere.  
 come were we the police men in the way

*Lesen* (*read*) selects *die Leviten* via VCOMP. Like in the *müssen* case, *lesen* cannot be moved into the *Vorfeld* because its VCOMP value is not saturated. *Die Leviten* cannot be attracted by *werden* because it is not part of the COMPS list of *lesen*. If *die Leviten* would be selected via the COMPS list like suggested by Krenn and Erbach (1994) the data in (26) would not be explainable.

### 3.3 The Problem of Underspecified COMPS Lists

In this section, I will address a problem that seems to have gone unnoticed until now. All analyses that involve argument attraction admit signs with underspecified COMPS lists. So in (2), *wird* is combined with a trace, or a lexical rule is applied to it. The LOC value of the verbal complement is put into SLASH, and the arguments of the verbal complement are attracted by the matrix verb. This list of arguments, however, is not instantiated in the resulting sign. It remains variable until the SLASH element becomes bound. Therefore, the HPSG principles admit any kind of combination of totally unrelated signs. Since the COMPS list of the head is variable, any constituent is a possible complement.<sup>16</sup> As an HPSG theory is assumed to be a set of constraints that describe well formed descriptions of linguistic objects, this is clearly not desirable. If a grammar contains phonologically empty elements (traces, relativizers, and the like), the set of ill-formed signs will be infinite because *wird*  $\_i$  could be combined with any number of empty elements.<sup>17</sup>

It is clear that we want the matrix verb to behave in a very well-defined way. It shall attract precisely those arguments of the fronted verbal projection that were not saturated by this projection, i.e., the matrix verb shall perform the argument attraction that would take place in base position, abstracting away from the value of LEX. The desired effect can be reached if a rule schema is used for the introduction of nonlocal dependencies. To introduce a nonlocal dependency for

<sup>16</sup>The same problem exists for analyses that treat verb second as verb movement (Kiss and Wesche, 1991; Netter, 1992).

<sup>17</sup>For a bottom-up parser, this would mean non-termination.

a verbal complex, this schema requires an additional licensing condition to be met. The extracted element is licensed by an actually existing verbal projection in the string. When the hearer of a sentence hears the words that have to be combined with a trace or introduce the nonlocal dependency in another way, he or she has already heard the phrase actually located in the *Vorfeld*. Therefore, the information about the nonlocal dependency is present and can be used to license the extracted element. The COMPS list of the extracted element is therefore specified. As the specified COMPS are attracted by the matrix verb the COMPS list of the matrix verb does not contain any variables and hence our theory does not admit signs that do not describe linguistic objects.

### Schema 5 (PVP-SLASH-Introduction-Schema (Complement))

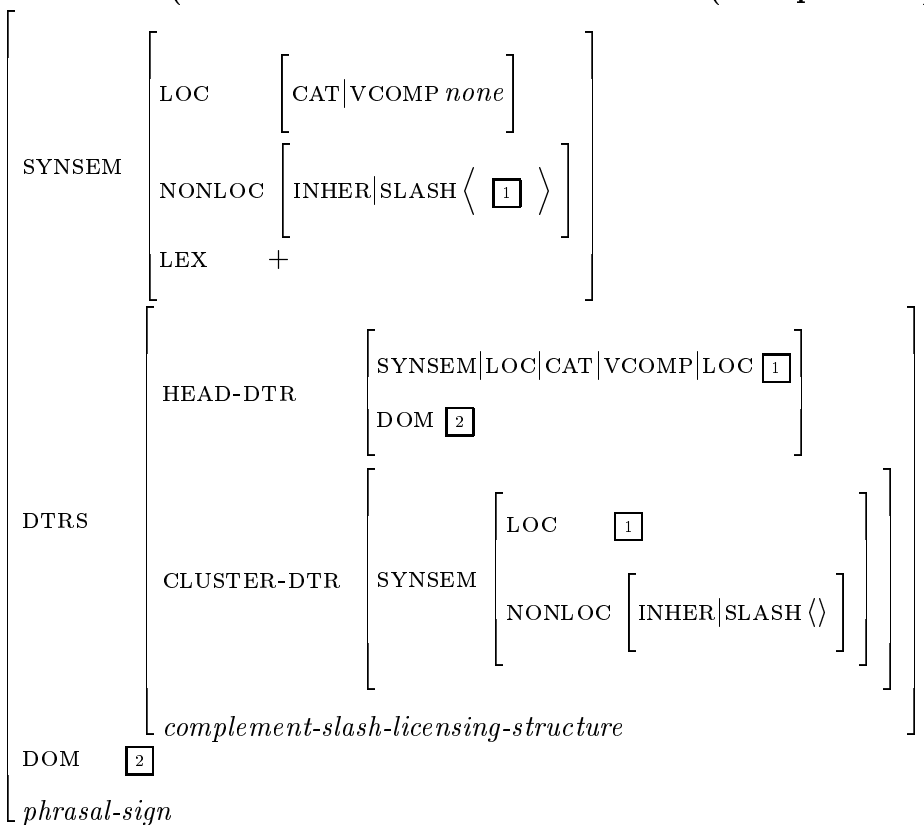

Schema 5 shows how this is implemented. A verbal complement of a matrix verb is saturated. The VCOMP value of the resulting sign is *none*. The LOC value of the saturated verbal complement is moved into SLASH. This LOC value is licensed by another verbal projection that meets the local requirements of the matrix verb, but may be positioned in the *Vorfeld*. As there are no constraints for daughters to be adjacent to each other, there may be an arbitrary number of constituents between the licensing daughter and the head daughter. The licensing daughter has a licensing function only, and is not inserted into the domain of the resulting sign ([2]) at this point of combination. However, an appropriate sign is inserted into the domain of its head when the nonlocal dependency is bound.

Schema 6 is the analogous for head-adjunct structures.

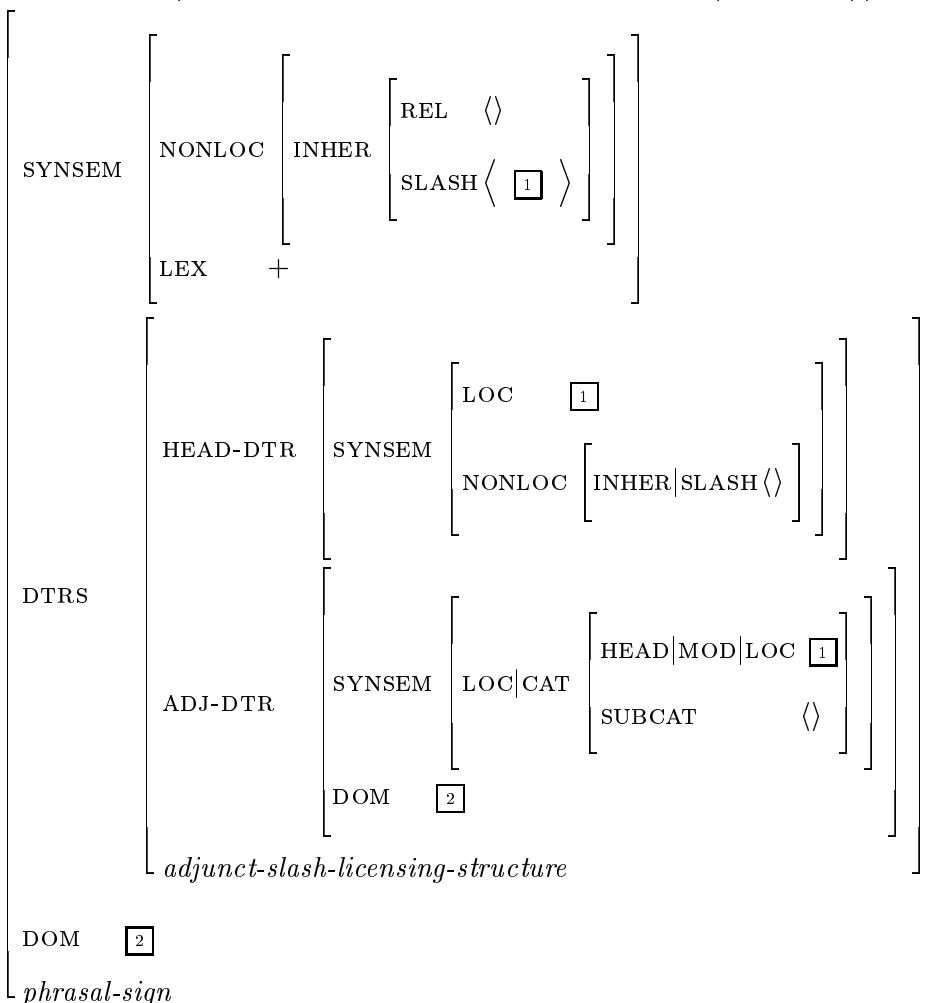
**Schema 6 (PVP-SLASH-Introduction-Schema (Adjunct))**

## 4 Extraposition and Third Construction in Fronted Constituents

Netter (1991, p. 27) claims that the following sentences are problematic for a theory of nonlocal dependencies that relates the fronted constituent to a trace.

- (27) a. [Versucht, zu lesen], hat er das Buch nicht.  
 tried to read has he the book not  
 'He didn't try to read the book.'
- b. [Versucht, einen Freund vorzustellen], hat er ihr noch nie.  
 tried a friend to introduce has he her yet never  
 'He has never tried introducing a friend to her.'

This, however, is not true. Both sentences can be seen as instances of the so-called Third Construction<sup>18</sup>. The structure of the verbal complexes is the same as the structure in (28). The only difference between (27) and (28) is that a part of the verbal complex is fronted.

<sup>18</sup>The name Third Construction was introduced by den Besten and Rutten (1989) to describe a similar phenomenon in Dutch. Uszkoreit (1987, p. 151) uses the term Focus Raising.

- (28) a. Deshalb hat er das Buch nicht [versucht, zu lesen].  
 therefore has he the book not tried to read
- b. Deshalb hat er ihr noch nie [versucht, einen Freund  
 therefore has he her yet never tried a friend  
 vorzustellen].  
 to introduce

I analyze Third Construction as a combination of argument attraction and extraposition. So in (28b), the phrase *einen Freund vorzustellen* is extraposed. The arguments of *vorstellen* that are not saturated (*ihr*) are attracted by the governing verb *versucht*, and are saturated in the *Mittelfeld*, i.e. to the left of the verbal complex.

Figure 4 demonstrates how this works in detail.

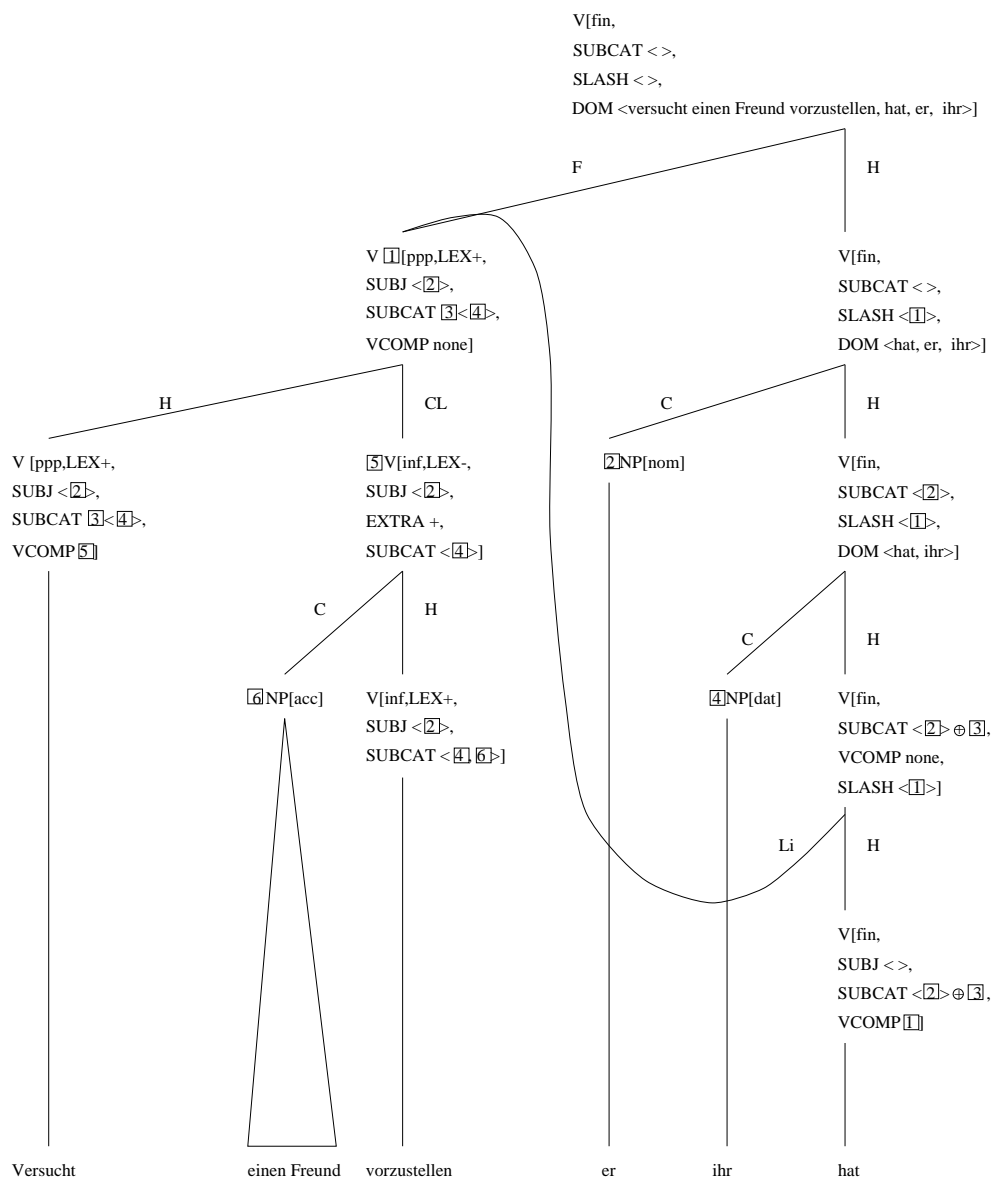
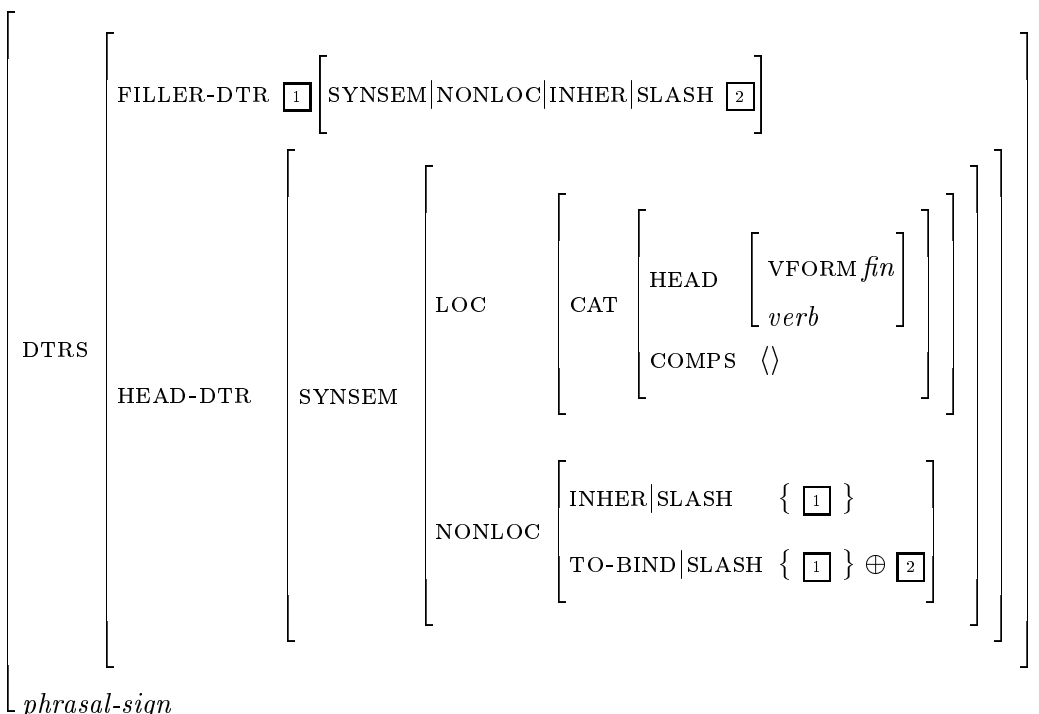

Figure 4: Analysis of *Versucht einen Freund vorzustellen hat er ihr.*

## 5 Alternatives

The drawback of the approaches of Pollard (1996) and Nerbonne (1994) are discussed in (Hinrichs and Nakazawa, 1994b). The arguments against these approaches will not be repeated here. Instead, Hinrichs and Nakazawa's approach will be explained and the problems related to such an approach will be highlighted. Hinrichs and Nakazawa use a special PVP-Topicalization Lexical Rule which is shown in (29) in addition to a slightly modified version of the complement extraction lexical rule (CELR) (Pollard and Sag, 1994, Chapter 9). For their mechanism to work, they changed the value of SLASH into a set of signs rather than *local* objects.<sup>19</sup> This lexical rule produces a lexical entry from the *bse*-form lexical entry.<sup>20</sup> The subject insertion lexical rule (finitivization lexical rule) is applied to the output of (29) and produces the finite form. (30) shows the result for the verb *werden*. With this entry and the schema 7 Hinrichs and Nakazawa can analyze the sentence (2a) as figure 5 shows.

### Schema 7 (Filler Head Schema following Hinrichs and Nakazawa)



The fronted VP is saturated.<sup>21</sup> The elements of the COMPS list of *erzählen* are contained in SLASH. The COMPS list of *wird* is the concatenation of the SLASH

<sup>19</sup>Hinrichs and Nakazawa use the feature geometry outlined in Chapter 9 of (Pollard and Sag, 1994). For the shake of consistency with the notation I use throughout the paper, I adapted their notation.

<sup>20</sup>Note that the negative constraint on  $\boxed{6}$  is not sufficient to block sentences like (9). The attraction of adjectives has to be blocked too.

<sup>21</sup>Note that this is not necessarily the case in the present approach. It is sometimes argued that the fronted constituent has to be a maximal projection, since extraposed constituents can be attached to the verbal projection in the *Vorfeld*. But if one uses accounts for extraposition like the ones proposed by Kathol and Pollard (1995) or Keller (1995), the projection an extraposed constituent is attached to can have an arbitrary saturation.

PVP Topicalization Lexical Rule by Hinrichs and Nakazawa:

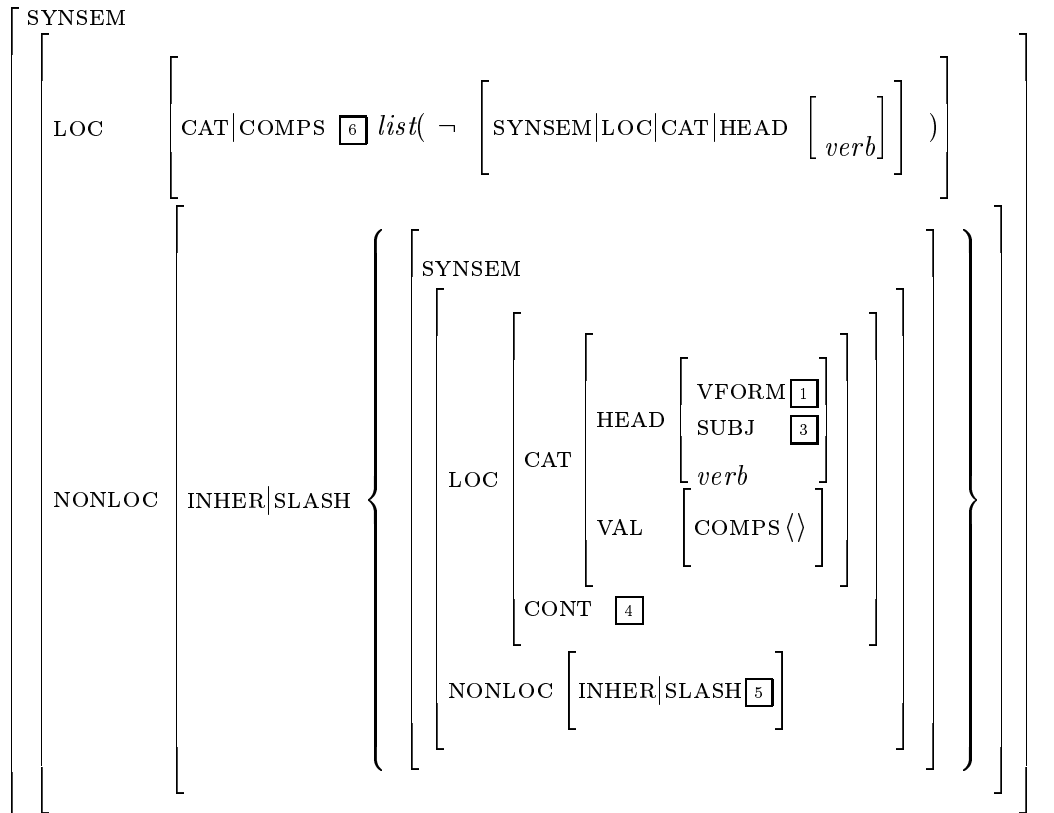
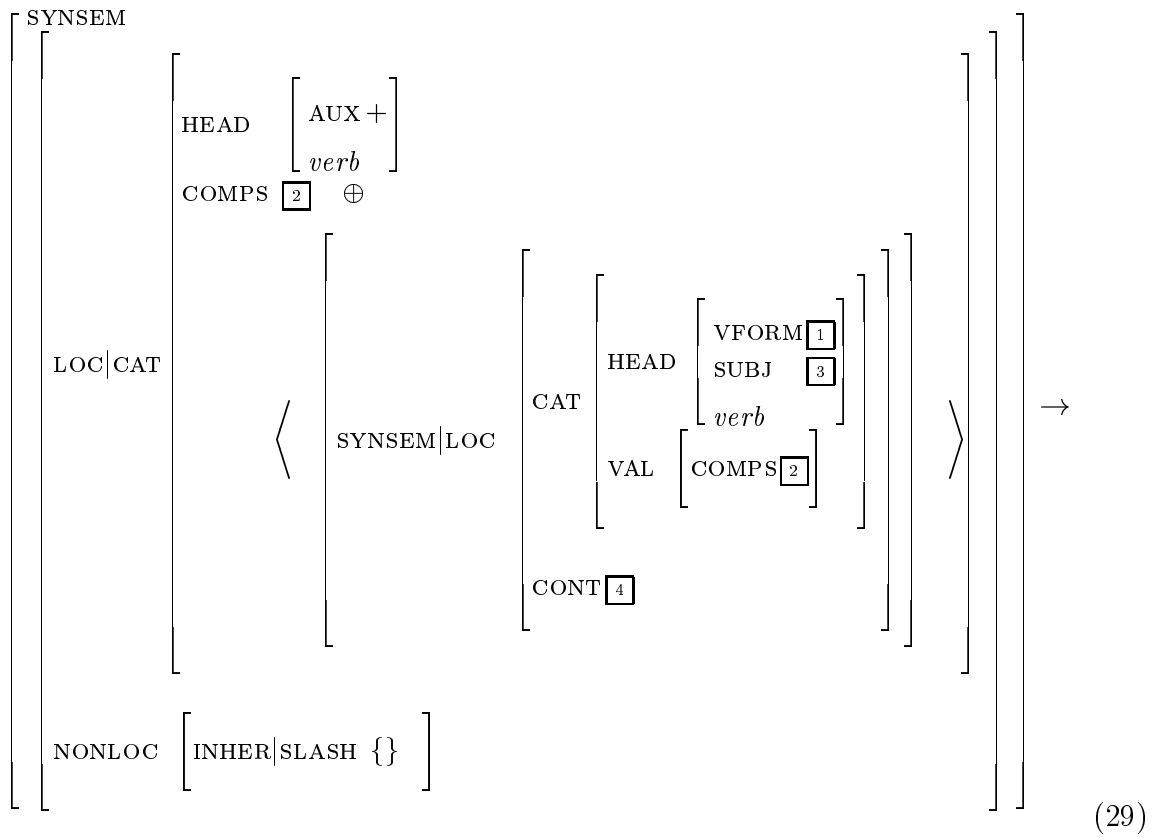

where: *same-member*( $\boxed{5}, \boxed{6}$ )



*wird* following Hinrichs and Nakazawa:

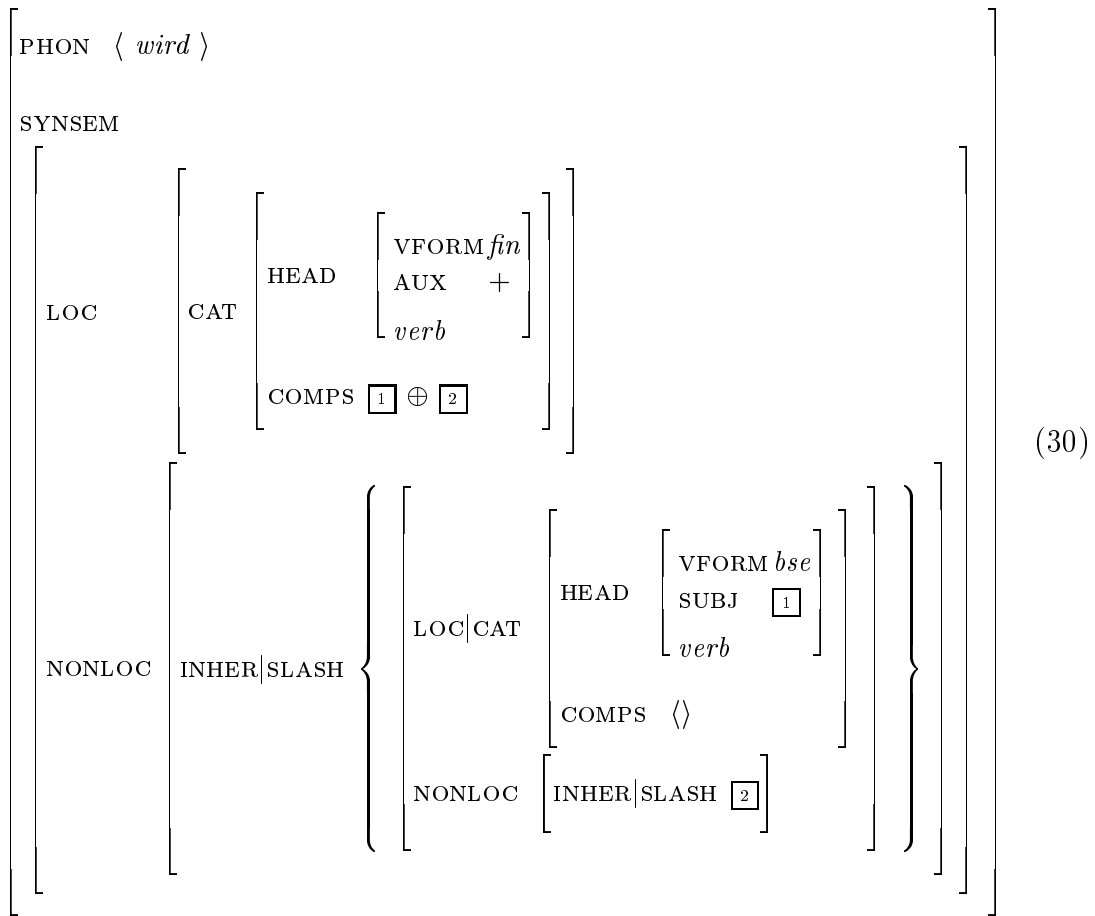

INHER|SLASH  $\boxed{2}$

(30)

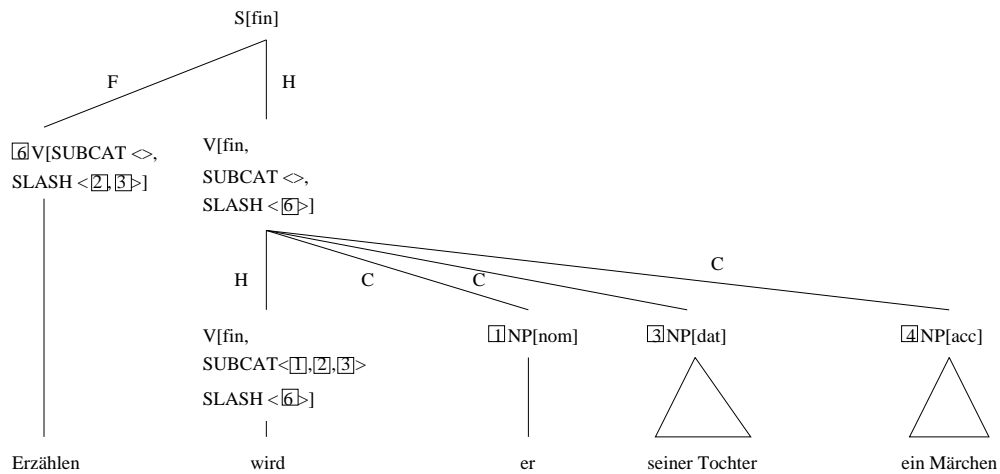

Figure 5: Analysis of *Erzählen wird er seiner Tochter ein Märchen* using Hinrichs and Nakazawa's approach

list and the SUBJ list of the embedded verbal complex. If the SLASH element introduced by the PVP Topicalization Lexical Rule is bound, the COMPS list of *wird* gets instantiated. It then contains precisely those elements extracted from the verbal complex. They are saturated as complements of the matrix verb and therefore located in the *Mittelfeld*, to the right of the finite verb. The specification of the COMPS list in the output description as a list that does not contain verbal elements is necessary to block the argument attraction of verbal complements. If verbal complements are listed under VCOMP, this specification of a list type is not needed.

The structure sharing of COMPS in the input description blocks the application to finite forms of auxiliaries. This blocks the fronting of the subject together with parts of the verbal complex, and avoids spurious ambiguities.

- (31) \* Er erzählen wird ihr das Märchen.  
       he tell       will her the fairy tale

The structure sharing makes the fronting of verbal complexes in passive constructions impossible if passive is described as object to subject raising (Pollard, 1994).

- (32) Gelesen wurde das Buch oft.  
       read       was       the book often  
       ‘The book was read a lot.’

In passive constructions, a change in argument structure takes place. So the PVP rule could not be applied to the passive auxiliary *werden*. To remedy this defect one would have to specify the VFORM in the input description as non-finite. One could then omit the structure sharing of the COMPS lists. However, whether one changes the rule or not, it remains the case that the PVP rule has to be applied before the finitization lexical rule. This means that either a finite form has to be produced from a *bse*-form, or in a system that has a somewhat more elaborated morphology component, the PVP rule would have to map stems to stems. Then the PVP rule would be the only rule known so far that leaves the major category the same, and only changes just valance specifications of stems.

A more serious problem that was pointed out by Hinrichs and Nakazawa themselves is posed by sentences like (33).

- (33) \* Gewußt, daß Peter <sub>-i</sub> schlägt, habe ich sie<sub>i</sub>.  
       known   that Peter hit       have I her  
       ‘I knew that Peter hit her.’

In (33), *sie* is extracted from the complement sentence of *gewußt*, and then inserted into the COMPS list of *habe* and saturated in the *Mittelfeld*. The same problem arises for other constructions, if they are analyzed by means of nonlocal dependencies.<sup>22</sup>

- (34) a. [Da]<sub>i</sub> hatte Karl [<sub>-i</sub> mit] gerechnet.  
       this had Karl with counted.on  
       ‘Karl expected this.’

---

<sup>22</sup>For an analysis of stranded prepositions in terms of nonlocal dependencies see (Rentier, 1994b) and (Müller, 1997c).

- b. \* [ [  $-_i$  mit] gerechnet ] hatte [da]<sub>i</sub> Karl.
- (35) a. Bus<sub>i</sub> will Karl [  $-_i$  fahren].  
 bus wants Karl drive  
 ‘Karl wants to go by bus.’
- b. \* [  $-_i$  fahren] will Karl bus<sub>i</sub>.

Another problem is the treatment of adjuncts that remain in the *Mittelfeld*.

- (36) Gelesen hat er oft in der Vorlesung.  
 read has he often in the lecture  
 ‘He often read during the lecture.’

To allow *oft* and *in der Vorlesung* to modify *gelesen* nonlocal dependencies must be introduced in the *Vorfeld*. This can be done with traces or with a schema, but a lexical rule probably would be more in the spirit of the approach of Hinrichs and Nakazawa.

As the value of SLASH is a set in the HPSG standard theory and in Hinrichs and Nakazawa’s approach, Hinrichs and Nakazawa cannot account for scope phenomena. In German scope relations are coupled with serialization. An adverb in the *Mittelfeld* scopes out all other adverbs that are serialized to its right in the *Mittelfeld*.<sup>23</sup> The adjuncts that were extracted from the fronted complex would be inserted via the lexical rule (29) without any constraints on their order. This problem disappears if it is assumed that SLASH is a list rather than a set.

Another problem with the lexical rule approach for adjunct fronting is that the lexical rule produces an infinite lexicon which is not possible to process without lazy evaluation techniques.<sup>24</sup> Even without a lexical rule for adjunct fronting an infinite number of nonlocal dependencies must be introduced which would lead to non-termination in bottom-up processing unless special processing techniques are used.

## 6 Problems

### 6.1 Fronting of Projections that Include Subjects

Sentences like the following are problematic for all accounts that use a SUBJ feature to single out the subject of non finite verbs:

- (37) a. Und rate mal, was dann gemacht wurde!  
 Ein Witz erzählt wurde.  
 a joke<sub>nom</sub> told was  
 ‘A joke was told.’
- b. Ein solch schönes Geschenk gemacht wurde mir noch nie.  
 a such nice present<sub>nom</sub> made was me yet never  
 ‘I never got such a nice present.’

<sup>23</sup>Kasper (1994) claims that there is a class of adverbs that behaves differently but Kiss (1995, p. 212) has shown that this is wrong.

<sup>24</sup>See (van Noord and Bouma, 1994).

- c. Zwei Männer erschossen wurden während des Wochenendes.<sup>25</sup>  
 two men shot were during the weekend  
 ‘Two men were shot during the weekend.’

In (37) the nominative noun phrases are subjects of the finite verb, i.e. of *wurde*. A projection like *ein Witz erzählt* cannot be obtained because *ein Witz* is not an element of the subcat list of *erzählen*.

This problem is not restricted to the passive cases as (38) shows.

- (38) a. Solch ein Fehler unterlaufen war ihm noch nie.<sup>26</sup>  
 such a mistake undergone was him still never  
 ‘Until now, he had never made such a mistake.’

- b. Viel passieren kann ihnen nicht.<sup>27</sup>  
 much happen can them not  
 ‘Not much can happen to them.’

However, if one assumes that the subject of ergative verbs and the subject in passive constructions is contained in the subcat list, it would be possible to analyze the sentences in (37-38).<sup>28</sup>

Sentences like (39) remain unexplainable.

- (39) ? Den Sänger jodeln läßt der König.<sup>29</sup>  
 the singer<sub>acc</sub> yodel lets the king<sub>nom</sub>  
 ‘The king lets the singer yodel.’

In (39), *den Sänger* is the subject of *jodeln* and is fronted together with the verb. It nevertheless receives case from the finite verb. Case assignment usually interacts either with positions of elements on the COMPS list (Heinz and Matiassek, 1994; Müller, 1997b) or with a specially marked element (designated argument/prominent argument) (Lebeth, 1994). Both accounts cannot explain sentences like (39).

## 6.2 Adjectives in the Verbal Complex

If adjectives are a part of the verbal complex, it remains unclear, how sentences like (40) could be explained.

- (40) a. Ich sah keinen Grund, eifersüchtig zu sein, und war es doch.<sup>30</sup>  
 I saw no reason jealous to be and was it yet  
 ‘I did not see a reason for being jealous but I nevertheless was jealous.’
- b. Ich sah keinen Grund, eifersüchtig zu sein, und bin es  
 I saw no reason jealous to be and have it  
 dennoch gewesen.  
 nevertheless been.

<sup>25</sup>(Webelhuth, 1985, p. 210)

<sup>26</sup>(Uszkoreit, 1987, p. 55), see also (Haider, 1985, p. 236)

<sup>27</sup>News Magazine, Tagesthemen, 23.11.95

<sup>28</sup>Cf. (Perlmutter, 1978; Baker, 1994)

<sup>29</sup>(Oppenrieder, 1991, p. 57)

<sup>30</sup>(Hoberg, 1981, p. 93)

The pronoun *es* refers to *eifersüchtig* and is positioned in the *Mittelfeld*. In (40b) *es* is separated from the verbal complex by an adverb. One could argue that the sentences in (40) are analogous to those in (41), i.e. that there is a incoherent construction for copulas and adjectives.<sup>31</sup>

- (41) a. Karl versuchte gestern, den Schatz zu finden und Peter wird  
 karl tried yesterday the treasure to find and Peter will  
 es morgen versuchen.  
 it tomorrow try  
 ‘Karl yesterday tried to find the treasure and Peter will do so  
 tomorrow.’
- b. , weil Karl gestern versuchte [den Schatz zu finden].  
 because Karl yesterday tried the treasure to find
- c. , weil Karl [den Schatz zu finden] gestern versuchte.  
 because Karl the treasure to find yesterday tried  
 ‘because it was yesterday that Karl tried to find the treasure.’

In coherent constructions like (42) the pronominalization is impossible (42a). The extraposition (42b) and intraposition (42c) of the infinitive is excluded too.

- (42) a. \* Karl schien gestern, den Schatz zu finden und Peter  
 Karl seemed yesterday the treasure to find and Peter  
 wird es morgen scheinen.  
 will it tomorrow seem  
 Intended: ‘Karl yesterday seemed to find the treasure and Peter will  
 tomorrow seem to find the treasure.’
- b. \* , weil Karl gestern schien den Schatz zu finden.  
 because Karl yesterday seemed the treasure to find
- c. \* , weil Karl den Schatz zu finden gestern schien.  
 because Karl the treasure to find yesterday seemed

(42b-c) are explained if one assumes that there is no constituent *den Schatz zu finden*. In coherent constructions, the verbs form a verbal complex that cannot be interrupted by adverbs.<sup>32</sup> (42c) therefore is excluded. (42b) is ruled out because *scheinen* obligatory raises all arguments of *finden*.

So if one assumes that there are incoherent constructions for copula verbs, one can explain the serialization of the pronoun in (40) but then one has to explain the ungrammaticality of the extraposition of adjective phrases.

- (43) a. \* Karl ist gewesen [auf seinen Sohn stolz].  
 Karl has been of his son proud  
 Intended: ‘Karl was proud of his son.’

<sup>31</sup>For the definition of the terms coherent and incoherent construction see (Bech, 1955).

<sup>32</sup>This is a simplification as there are constructions like Verb Projection Raising. For details see (Hinrichs and Nakazawa, 1994a; Müller, 1997b).

- b. \* Karl ist gewesen [stolz auf seinen Sohn].  
 Karl has been proud of his son

In German maximal projections can be extraposed.<sup>33</sup> Some kinds of extraposition are marked, like for instance the extraposition of NP complements. But there are examples for NP extraposition both from spoken and from written language. However, (43) seems to be completely out and I could not find any example for AP extraposition. Intraposition also seems to be impossible.

- (44) a. \* , weil [auf so einen Sohn stolz] niemand ist.  
 b. \* , weil [stolz auf so einen Sohn] niemand ist.

### 6.3 Spurious Ambiguities

The sentence (45) has two analyses.

- (45) Geholfen hat sie ihm, das Buch zu lesen.  
 helped has she him the book to read  
 ‘She helped him read the book.’

In one analysis, the phrase *das Buch zu lesen* is attracted as an argument and saturated in the *Mittelfeld*, and in the other reading it is extraposed from the fronted verbal projection. This is not a problem for the account of Hinrichs and Nakazawa, as they explicitly block the attraction of verbal arguments. Sentences like (46b), however, are completely analogous:

- (46) a. Karl hat nachgedacht darüber.  
 Karl has thought about.this  
 b. Nachgedacht hat Karl darüber.

If no information about intonation is present, i.e. if written language is analyzed, the extraposition reading might be excluded by stating the constraint, that the right sentence bracket must be occupied if a constituent is analyzed as extraposed.

## 7 Conclusion

A very simple solution for the PVP problem has been found. A minor change in the feature geometry of signs is sufficient to cope with the spurious ambiguity problem of Pollard’s (1996) account.

The analysis that was argued for in this paper can account for adjuncts of fronted elements that remain in the *Mittelfeld*. The assumption of an infinite lexicon is not necessary.

A solution to the problem of underspecified COMPS lists was found. This solution makes use of a schema to introduce the nonlocal dependency. An introduced non-local dependency is licensed by a phonologically realized element in the syntactic analysis of a string. At the point of combination, this element plays a licensing

---

<sup>33</sup>See (Müller, 1997b).

role only, and does not appear in the surface string of the built sign. This is possible because two different levels of representation for combinatorial and order information are used.

The analysis is part of an implemented fragment of German (Müller, 1996).

## References

Baker, Kathryn L. 1994. An integrated account of “modal flip” and partial verb phrase fronting in German. In *Papers from the 30th Regional Meeting of the Chicago Linguistic Society*, Chicago, Illinois.

Bech, Gunnar. 1955. *Studien über das deutsche Verbum infinitum*. Linguistische Arbeiten 139. Tübingen: Max Niemeyer Verlag. 2., unveränderte Auflage, 1983.

Bouma, Gosse and Gertjan van Noord. 1996. Word order constraints on German verb clusters. In *Proceedings of Formal Grammar 96*, pages 15–28, Prag. <http://www.let.rug.nl/~vannord/papers/>. 07.24.97.

den Besten, Hans and Jean Rutten. 1989. On verb raising, extraposition and free word order in Dutch. In Dany Jaspers, Wim Klooster, Yvan Putsey, and Pieter Seuren, editors, *Sentential Complementation and the Lexicon: Studies in Honour of Wim de Geest*. Foris Publications, Dordrecht: Holland, Cinnaminson: U.S.A., pages 41–56.

Haider, Hubert. 1985. Über sein oder nicht sein: Zur Grammatik des Pronomens sich. In Werner Abraham, editor, *Erklärende Syntax des Deutschen*, Studien zur deutschen Grammatik, Nummer 25. Gunter Narr Verlag, Tübingen, pages 223–254.

Haider, Hubert. 1990. Topicalization and other puzzles of German syntax. In Günther Grewendorf and Wolfgang Sternefeld, editors, *Scrambling and Barriers*, Linguistik Aktuell / Linguistics Today. John Benjamins Publishing Company, Amsterdam, Philadelphia, pages 93–112.

Heinz, Wolfgang and Johannes Matiasek. 1994. Argument structure and case assignment in German. In John Nerbonne, Klaus Netter, and Carl J. Pollard, editors, *German in Head-Driven Phrase Structure Grammar*, CSLI Lecture Notes, Number 46. Center for the Study of Language and Information, Stanford, chapter 6, pages 199–236.

Hinrichs, Erhard W. and Tsuneko Nakazawa. 1994a. Linearizing AUXs in German verbal complexes. In John Nerbonne, Klaus Netter, and Carl J. Pollard, editors, *German in Head-Driven Phrase Structure Grammar*, CSLI Lecture Notes, Number 46. Center for the Study of Language and Information, Stanford, chapter 1, pages 11–38.

Hinrichs, Erhard W. and Tsuneko Nakazawa. 1994b. Partial-VP and split-NP topicalization in German—an HPSG analysis. In Erhard W. Hinrichs, Walt Detmar

- Meurers, and Tsuneko Nakazawa, editors, *Partial-VP and Split-NP Topicalization in German—An HPSG Analysis and its Implementation*, Arbeitspapiere des Sonderforschungsbereiches 340, Bericht Nr. 58. Universität Tübingen. <ftp://ling.ohio-state.edu/pub/HPSG/Workshop.LLI.94/hinrichs-nakazawa.ps.Z>. 09.07.97.
- Hoberg, Ursula. 1981. Die Wortstellung in der geschriebenen deutschen Gegenwartssprache. *Heutiges Deutsch*, 1(10).
- Johnson, Mark. 1986. A GPSG account of VP structure in German. *Linguistics*, 24(5):871–882.
- Kasper, Robert. 1994. Adjuncts in the Mittelfeld. In John Nerbonne, Klaus Netter, and Carl J. Pollard, editors, *German in Head-Driven Phrase Structure Grammar*, CSLI Lecture Notes, Number 46. Center for the Study of Language and Information, Stanford, chapter 2, pages 39–70.
- Kathol, Andreas. 1995. *Linearization-Based German Syntax*. Ph.D. thesis, Ohio State University.
- Kathol, Andreas and Carl J. Pollard. 1995. Extraposition via complex domain formation. In *Proceedings of the Thirty-Third Annual Meeting of the ACL*, Boston. Association for Computational Linguistics. <http://linguistics.berkeley.edu/~kathol/Papers/ACL95.ps.gz>. 09.21.97.
- Keller, Frank. 1995. Towards an account of extraposition in HPSG. In *Proceedings of the Seventh Conference of the European Chapter of the Association for Computational Linguistics*, Dublin. <ftp://ftp.ims.uni-stuttgart.de/pub/papers/keller/eacl95.ps.gz>. 04.15.97.
- Kiss, Tibor. 1993. Infinite Komplementation – Neue Studien zum deutschen Verbum infinitum. Arbeiten des Sonderforschungsbereiches 282 Nummer 42, Bergische Universität Gesamthochschule Wuppertal.
- Kiss, Tibor. 1994. Obligatory coherence: The structure of German modal verb constructions. In John Nerbonne, Klaus Netter, and Carl J. Pollard, editors, *German in Head-Driven Phrase Structure Grammar*, CSLI Lecture Notes, Number 46. Center for the Study of Language and Information, Stanford, chapter 3.
- Kiss, Tibor. 1995. *Merkmale und Repräsentationen*. Opladen/Wiesbaden: Westdeutscher Verlag.
- Kiss, Tibor and Birgit Wesche. 1991. Verb order and head movement. In O. Herzog and C.-R. Rollinger, editors, *Text Understanding in LILOG*, Lecture Notes in Artificial Intelligence, Number 546. Springer-Verlag, Berlin Heidelberg New York, pages 216–242.
- Krenn, Brigitte and Gregor Erbach. 1994. Idioms and support verb constructions. In John Nerbonne, Klaus Netter, and Carl J. Pollard, editors, *German in Head-Driven Phrase Structure Grammar*, CSLI Lecture Notes, Number 46. Center for the Study of Language and Information, Stanford, chapter 11, pages 365–396. <http://coli.uni-sb.de/claus/claus28.html>. 09.11.97.



- Lebeth, Kai. 1994. Morphosyntaktischer Strukturaufbau – Die Generierung komplexer Verben im HPSG-Lexikon eines Sprachproduktionssystems. Hamburger Arbeitspapiere zur Sprachproduktion – IV Arbeitspapier Nr. 16, Universität Hamburg, Fachbereich Informatik.
- Müller, Stefan. 1996. The Babel-System—an HPSG Prolog implementation. In *Proceedings of the Fourth International Conference on the Practical Application of Prolog*, pages 263–277, London. [http://www.dfki.de/~stefan/Pub/e\\_babel.html](http://www.dfki.de/~stefan/Pub/e_babel.html). 09.23.1997.
- Müller, Stefan. 1997a. Complement extraction lexical rules and argument attraction. Research Report RR-97-08, Deutsches Forschungszentrum für Künstliche Intelligenz, Saarbrücken. A shorter version appeared in *Natural Language Processing and Speech Technology. Results of the 3rd KONVENS Conference, Bielefeld, October 1996*. [http://www.dfki.de/~stefan/Pub/e\\_case\\_celr.html](http://www.dfki.de/~stefan/Pub/e_case_celr.html). 09.23.1997.
- Müller, Stefan. 1997b. *Head-Driven Phrase Structure Grammar für das Deutsche*. Lecture Notes Computational Linguistics. Humboldt Universität zu Berlin. [http://www.dfki.de/~stefan/Pub/e\\_hpsg.html](http://www.dfki.de/~stefan/Pub/e_hpsg.html). 09.23.1997.
- Müller, Stefan. 1997c. Scrambling in German – extraction into the *Mittelfeld*. Research Report RR-97-06, Deutsches Forschungszentrum für Künstliche Intelligenz, Saarbrücken. A shorter version appeared in *Proceedings of the tenth Pacific Asia Conference on Language, Information and Computation*. City University of Hong Kong. 1995. [http://www.dfki.de/~stefan/Pub/e\\_scrambling.html](http://www.dfki.de/~stefan/Pub/e_scrambling.html). 09.23.1997.
- Nerbonne, John. 1986. ‘Phantoms’ and German fronting: Poltergeist constituents? *Linguistics*, 24:857–870.
- Nerbonne, John. 1994. Partial verb phrases and spurious ambiguities. In John Nerbonne, Klaus Netter, and Carl J. Pollard, editors, *German in Head-Driven Phrase Structure Grammar*, CSLI Lecture Notes, Number 46. Center for the Study of Language and Information, Stanford, chapter 4, pages 109–150.
- Netter, Klaus. 1991. Clause union phenomena and complex predicates in German. In Klaus Netter and Mike Reape, editors, *Clause Structure and Word Order Variation in Germanic*, DYANA Report, Deliverable R1.1.B. University of Edinburgh, January.
- Netter, Klaus. 1992. On non-head non-movement. An HPSG treatment of finite verb position in German. In Günther Görz, editor, *Konvens 92*, pages 218–227, Berlin, Heidelberg, New York. Springer-Verlag.
- Oppenrieder, Wilhelm. 1991. *Von Subjekten, Sätzen und Subjektsätzen*. Linguistische Arbeiten 241. Tübingen: Max Niemeyer Verlag.
- Perlmutter, David M. 1978. Impersonal passives and the unaccusative hypothesis. In *Proceedings of the 4th Annual Meeting of the Berkeley Linguistics Society*, pages 157–189.

- Pollard, Carl J. 1994. Toward a unified account of passive in German. In John Nerbonne, Klaus Netter, and Carl J. Pollard, editors, *German in Head-Driven Phrase Structure Grammar*, CSLI Lecture Notes, Number 46. Center for the Study of Language and Information, Stanford, chapter 8, pages 273–296.
- Pollard, Carl J. 1996. On head nonmovement. In Harry Bunt and Arthur van Horck, editors, *Discontinuous Constituency*, Natural language processing 6. Mouton de Gruyter, Berlin, New York.
- Pollard, Carl J. and Ivan A. Sag. 1987. *Information-Based Syntax and Semantics Volume 1 Fundamentals*. CSLI Lecture Notes, Number 13. Stanford: Center for the Study of Language and Information.
- Pollard, Carl J. and Ivan A. Sag. 1994. *Head-Driven Phrase Structure Grammar*. University of Chicago Press.
- Reape, Mike. 1994. Domain union and word order variation in German. In John Nerbonne, Klaus Netter, and Carl J. Pollard, editors, *German in Head-Driven Phrase Structure Grammar*, CSLI Lecture Notes, Number 46. Center for the Study of Language and Information, Stanford, chapter 5, pages 151–198.
- Reis, Marga. 1980. On justifying topological frames: 'positional field' and the order of nonverbal constituents in German. *DRLAV*, 22/23:59–85.
- Rentier, Gerrit. 1994a. Dutch cross serial dependencies in HPSG. In *Proceedings of COLING 94*, pages 818–822, Kyoto, Japan. <http://xxx.lanl.gov/abs/cmp-lg/9410016>. 07.24.97.
- Rentier, Gerrit. 1994b. A lexicalist approach to Dutch preposition stranding. In Harald Trost, editor, *Tagungsband Konvens 94, Verarbeitung natürlicher Sprache*, pages 280–289.
- Uszkoreit, Hans. 1987. *Word Order and Constituent Structure in German*. CSLI Lecture Notes, Number 8. Stanford: Center for the Study of Language and Information.
- van Noord, Gertjan and Gosse Bouma. 1994. The scope of adjuncts and the processing of lexical rules. In *Proceedings of COLING, 1994*, Kyoto Japan. <http://grid.let.rug.nl/~vannoord/papers/coling94.ps.gz>. 09.07.97.
- Webelhuth, Gert. 1985. German is configurational. *The Linguistic Review*, 4:203–246.

**Yet Another Paper about Partial Verb Phrase Fronting in German**

**Stefan Müller**

**RR-97-07**  
Research Report